

DS

VS

6951

306

6951-2

306-2

6951-3

306-3

6951-4

306-4

6951-5

306-5

Click on the  in the manual to watch the video tutorials.



Scan the QR code to go and subscribe our tutorial channel

vtech[®]

User's manual

Congratulations

on purchasing your new VTech product. Before using this telephone, please read Important safety instructions.

This manual has all the feature operations and troubleshooting necessary to install and operate your new VTech telephone. Please review this manual thoroughly to ensure proper installation and operation of this innovative and feature rich VTech product.

For support, shopping, and everything new at VTech, visit our website at www.vtechphones.com. In Canada, please visit phones.vtechcanada.com.



Telephones identified with this logo have reduced noise and interference when used with most T-coil equipped hearing aids and cochlear implants. The TIA-1083 Compliant Logo is a trademark of the Telecommunications Industry Association. Used under license.



The ENERGY STAR® program (www.energystar.gov) recognizes and encourages the use of products that save energy and help protect our environment. We are proud to mark this product with the ENERGY STAR® label indicating it meets the latest energy efficiency guidelines.



Important safety instructions

When using your telephone equipment, basic safety precautions should always be followed to reduce the risk of fire, electric shock and injury, including the following:

1. Read and understand all instructions.
2. Follow all warnings and instructions marked on the product.
3. Unplug this product from the wall outlet before cleaning. Do not use liquid or aerosol cleaners. Use a damp cloth for cleaning.
4. **CAUTION:** Do not install the telephone base at a height above 2 meters.
5. Do not use this product near water such as near a bath tub, wash bowl, kitchen sink, laundry tub or a swimming pool, or in a wet basement or shower.
6. Do not place this product on an unstable table, shelf, stand or other unstable surfaces.
7. Avoid placing the telephone system in places with extreme temperature, direct sunlight, or other electrical devices. Protect your phone from moisture, dust, corrosive liquids and fumes.
8. Slots and openings in the back or bottom of the telephone base and handset are provided for ventilation. To protect them from overheating, these openings must not be blocked by placing the product on a soft surface such as a bed, sofa or rug. This product should never be placed near or over a radiator or heat register. This product should not be placed in any area where proper ventilation is not provided.
9. This product should be operated only from the type of power source indicated on the marking label. If you are not sure of the type of power supply in your home or office, consult your dealer or local power company.
10. Do not allow anything to rest on the power cord. Do not install this product where the cord may be walked on.
11. Never push objects of any kind into this product through the slots in the telephone base or handset because they may touch dangerous voltage points or create a short circuit. Never spill liquid of any kind on the product.
12. To reduce the risk of electric shock, do not disassemble this product, but take it to an authorized service facility. Opening or removing parts of the telephone base or handset other than specified access doors may expose you to dangerous voltages or other risks. Incorrect

reassembling can cause electric shock when the product is subsequently used.

13. Do not overload wall outlets and extension cords.
14. Unplug this product from the wall outlet and refer servicing to an authorized service facility under the following conditions:
 - When the power supply cord or plug is damaged or frayed.
 - If liquid has been spilled onto the product.
 - If the product has been exposed to rain or water.
 - If the product does not operate normally by following the operating instructions. Adjust only those controls that are covered by the operation instructions. Improper adjustment of other controls may result in damage and often requires extensive work by an authorized technician to restore the product to normal operation.
 - If the product has been dropped and the telephone base and/or handset has been damaged.
 - If the product exhibits a distinct change in performance.
15. Avoid using a telephone (other than cordless) during an electrical storm. There is a remote risk of electric shock from lightning.
16. Do not use the telephone to report a gas leak in the vicinity of the leak. Under certain circumstances, a spark may be created when the adapter is plugged into the power outlet, or when the handset is replaced in its cradle. This is a common event associated with the closing of any electrical circuit. The user should not plug the phone into a power outlet, and should not put a charged handset into the cradle, if the phone is located in an environment containing concentrations of flammable or flame-supporting gases, unless there is adequate ventilation. A spark in such an environment could create a fire or explosion. Such environments might include: medical use of oxygen without adequate ventilation; industrial gases (cleaning solvents; gasoline vapors; etc.); a leak of natural gas; etc.
17. Only put the handset of your telephone next to your ear when it is in normal talk mode.
18. The power adapter is intended to be correctly oriented in a vertical or floor mount position. The prongs are not designed to hold the plug in place if it is plugged into a ceiling, under-the-table or cabinet outlet.

19. For pluggable equipment, the socket outlet shall be installed near the equipment and shall be easily accessible.
20.   Use only the batteries indicated in this manual. There may be a risk of explosion if a wrong type of battery is used for the handset. Use only the supplied rechargeable batteries or replacement batteries (BT162342/BT262342) for the handset. Do not dispose of batteries in a fire. They may explode.
- Do not use the battery in following conditions:
 - » High or low extreme temperature during use, storage or transportation.
 - » Replacement of a battery with an incorrect type that can defeat a safeguard.
 - » Disposal of a battery into fire or a hot oven, or mechanically crushing or cutting of a battery, that can result in an explosion.
 - » Leaving a battery in an extremely high temperature surrounding environment that can result in an explosion or the leakage of flammable liquid or gas.
 - » A battery subjected to extremely low air pressure that can result in an explosion or the leakage of flammable liquid or gas.
21. Use only the adapter included with this product. Incorrect adapter polarity or voltage can seriously damage the product.

SAVE THESE INSTRUCTIONS

Battery

- Use only the batteries provided or equivalent. To order a replacement, visit our website at www.vtechphones.com or call 1 (800) 595-9511. In Canada, go to phones.vtechcanada.com or call 1 (800) 267-7377.
- Do not dispose of the battery in a fire. Check with local waste management codes for special disposal instructions.
- Do not open or mutilate the battery. Released electrolyte is corrosive and may cause burns or injury to the eyes or skin. The electrolyte may be toxic if swallowed.
- Exercise care in handling batteries in order not to create a short circuit with conductive materials.
- Charge the battery provided with this product only in accordance with the instructions and limitations specified in this manual.

Precautions for users of implanted cardiac pacemakers

Cardiac pacemakers (applies only to digital cordless telephones):

Wireless Technology Research, LLC (WTR), an independent research entity, led a multidisciplinary evaluation of the interference between portable wireless telephones and implanted cardiac pacemakers. Supported by the U.S. Food and Drug Administration, WTR recommends to physicians that:

Pacemaker patients

- Should keep wireless telephones at least six inches from the pacemaker.
 - Should NOT place wireless telephones directly over the pacemaker, such as in a breast pocket, when it is turned ON.
 - Should use the wireless telephone at the ear opposite the pacemaker.
- WTR's evaluation did not identify any risk to bystanders with pacemakers from other persons using wireless telephones.

About cordless telephones

- **Privacy:** The same features that make a cordless telephone convenient create some limitations. Telephone calls are transmitted between the telephone base and the cordless handset by radio waves, so there is a possibility that the cordless telephone conversations could be intercepted by radio receiving equipment within range of the cordless handset. For this reason, you should not think of cordless telephone conversations as being as private as those on corded telephones.
- **Electrical power:** The telephone base of this cordless telephone must be connected to a working electrical outlet. The electrical outlet should not be controlled by a wall switch. Calls cannot be made from the cordless handset if the telephone base is unplugged, switched off or if the electrical power is interrupted.
- **Potential TV interference:** Some cordless telephones operate at frequencies that may cause interference to televisions and VCRs. To minimize or prevent such interference, do not place the telephone base of the cordless telephone near or on top of a TV or VCR. If interference is experienced, moving the cordless telephone farther away from the TV or VCR often reduces or eliminates the interference.

- **Rechargeable batteries:** Exercise care in handling batteries in order not to create a short circuit with conducting material such as rings, bracelets and keys. The battery or conductor may overheat and cause harm. Observe proper polarity between the battery and the battery charger.
- **Nickel-metal hydride rechargeable batteries:** Dispose of these batteries in a safe manner. Do not burn or puncture the battery. Like other batteries of this type, if burned or punctured, they could release caustic material which could cause injury.

ECO mode

This power conserving technology reduces power consumption for optimal battery performance. The ECO mode activities automatically whenever the handset is synchronized with the telephone base.

The RBRC seal

The RBRC seal on the nickel-metal hydride battery indicates that VTech Communications, Inc. is voluntarily participating in an industry program to collect and recycle these batteries at the end of their useful lives, when taken out of service within the United States and Canada.

The program provides a convenient alternative to placing used nickel-metal hydride batteries into the trash or municipal waste, which may be illegal in your area.

VTech's participation makes it easy for you to drop off the spent battery at local retailers participating in the program or at authorized VTech product service centers. Please call **1 (800) 8 BATTERY®** for information on Ni-MH battery recycling and disposal bans/restrictions in your area. VTech's involvement in this program is part of its commitment to protecting our environment and conserving natural resources.

The RBRC seal and 1 (800) 8 BATTERY® are registered trademarks of Call2recycle, Inc.



FCC, ACTA and IC regulations FCC Part 15

This equipment has been tested and found to comply with the requirements for a Class B digital device under Part 15 of the Federal Communications Commission (FCC) rules. These requirements are intended to provide reasonable protection against harmful interference in a residential installation. This equipment generates, uses and can radiate radio frequency energy and, if not installed and used in accordance with the instructions, may cause harmful interference to radio communications. However, there is no guarantee that interference will not occur in a particular installation. If this equipment does cause harmful interference to radio or television reception, which can be determined by turning the equipment off and on, the user is encouraged to try to correct the interference by one or more of the following measures:

- Reorient or relocate the receiving antenna.
- Increase the separation between the equipment and receiver.
- Connect the equipment into an outlet on a circuit different from that to which the receiver is connected.
- Consult the dealer or an experienced radio/TV technician for help.

Changes or modifications to this equipment not expressly approved by the party responsible for compliance could void the user's authority to operate the equipment.

This device complies with Part 15 of the FCC rules. Operation is subject to the following two conditions: (1) this device may not cause harmful interference, and (2) this device must accept any interference received, including interference that may cause undesired operation. Privacy of communications may not be ensured when using this telephone.

To ensure safety of users, the FCC has established criteria for the amount of radio frequency energy that can be safely absorbed by a user or bystander according to the intended usage of the product. This product has been tested and found to comply with the FCC criteria. The handset may be safely held against the ear of the user. The telephone base shall be installed and used such that parts of the user's body other than the hands are maintained at a distance of approximately 20 cm (8 inches) or more.

This Class B digital apparatus complies with Canadian requirement:
CAN ICES-3 (B)/NMB-3(B).

FCC Part 68 and ACTA

This equipment complies with Part 68 of the FCC rules and with technical requirements adopted by the Administrative Council for Terminal Attachments (ACTA). The label on the back or bottom of this equipment contains, among other things, a product identifier in the format US:AAAEQ##TXXXX. This identifier must be provided to your telephone service provider upon request.

The plug and jack used to connect this equipment to premises wiring and the telephone network must comply with applicable Part 68 rules and technical requirements adopted by ACTA. A compliant telephone cord and modular plug is provided with this product. It is designed to be connected to a compatible modular jack that is also compliant. An RJ11 jack should normally be used for connecting to a single line and an RJ14 jack for two lines. See the installation instructions in the user's manual.

The Ringer Equivalence Number (REN) is used to determine how many devices you may connect to your telephone line and still have them ring when you are called. The REN for this product is encoded as the 6th and 7th characters following the US: in the product identifier (e.g., if ## is 03, the REN is 0.3). In most, but not all areas, the sum of all RENs should be five (5.0) or less. For more information, please contact your telephone service provider.

This equipment may not be used with Party Lines. If you have specially wired alarm dialing equipment connected to your telephone line, ensure the connection of this equipment does not disable your alarm equipment. If you have questions about what will disable alarm equipment, consult your telephone service provider or a qualified installer.

If this equipment is malfunctioning, it must be unplugged from the modular jack until the problem has been corrected. Replacement to this telephone equipment can only be made by the manufacturer or its authorized agents. For replacement procedures, follow the instructions outlined under the "Limited warranty".

If this equipment is causing harm to the telephone network, the telephone service provider may temporarily discontinue your telephone service. The telephone service provider is required to notify you

before interrupting service. If advance notice is not practical, you will be notified as soon as possible. You will be given the opportunity to correct the problem and the telephone service provider is required to inform you of your right to file a complaint with the FCC. Your telephone service provider may make changes in its facilities, equipment, operation, or procedures that could affect the proper functioning of this product. The telephone service provider is required to notify you if such changes are planned.

If this product is equipped with a corded or cordless handset, it is hearing aid compatible.

If this product has memory dialing locations, you may choose to store emergency telephone numbers (e.g., police, fire, medical) in these locations. If you do store or test emergency numbers, please:

Remain on the line and briefly explain the reason for the call before hanging up.

Perform such activities in off-peak hours, such as early morning or late evening.

Industry Canada

This device contains licence-exempt transmitter(s)/ receiver(s) that comply with Innovation, Science and Economic Development Canada's licence-exempt RSS(s). Operation is subject to the following two conditions:

(1) This device may not cause interference.

(2) This device must accept any interference, including interference that may cause undesired operation of the device.

Privacy of communications may not be ensured when using this telephone.

The term "IC:" before the certification/registration number only signifies that the Industry Canada technical specifications were met.

The Ringer Equivalence Number (REN) for this terminal equipment is 1.0. The REN indicates the maximum number of devices allowed to be connected to a telephone interface. The termination on an interface may consist of any combination of devices subject only to the requirement that the sum of the RENs of all the devices not exceed five.

This product meets the applicable Innovation, Science and Economic Development Canada technical specifications.

California Energy Commission battery charging testing instructions

This telephone is set up to comply with the energy-conserving standards right out of the box. These instructions are intended for California Energy Commission (CEC) compliance testing only. When the CEC battery charging testing mode is activated, all telephone functions, except battery charging, will be disabled.

To activate the CEC battery charging testing mode:

1. Unplug the telephone base power adapter from the power outlet. Make sure all handsets are plugged with charged batteries before proceeding.
2. While you press and hold **FIND HS**, plug the telephone base power adapter back to the power outlet.
3. After about 20 seconds, when the **HOME** light starts flashing, release **FIND HS** and then press it again within two seconds. You hear a confirmation tone. The **HOME** light turns off and all handsets display **To register HS... see manual** alternately. Allow up to one minute for the process to complete.

If the phone fails to enter this mode, repeat all the steps mentioned above. The telephone base will be powered up as normal if you fail to press **FIND HS** within two seconds in Step 3.

To deactivate the CEC battery charging testing mode:

1. Unplug the telephone base power adapter from the power outlet, and then plug it back in. Then the telephone base is powered up as normal.
2. Put the handsets on the telephone base cradle to begin registration.
3. The handset shows **Registering...** If the registration is successful, the handset screen displays **Registered** and beeps. The handset is registered with the telephone base.

Contents

Install Set up	14	Answer a home call	31		
What is in the box	14	End a home call	31		
Install the battery	15	Make, answer or end a cell call	32	Change a one-to-one PTT call to an intercom call	45
Connect the telephone base	15	Make a cell call	32	Answer an incoming call during a PTT call	46
Connect the charger	16	Predial a cell call	32	Make an outgoing call during PTT call	46
Charge the battery	16	Answer a cell call	32	End or leave a PTT call	47
Check the battery level	17	End a cell call	32	Use the phone menu	47
Check for dial tone	17	Call waiting on the home line	33	Phonebook	48
Before use	18	Call waiting on the cell line	34	Add a phonebook entry	48
Set date and time	18	Sound	34	Add a predialed telephone number to the phonebook	49
Set up Smart call blocker through Voice Guide (Before use)	18	Use speakerphone	34	Review the phonebook entries	50
Set up Answering System through Voice Guide (Before use)	20	Control volume	34	Search by name	50
Install	21	Temporary ringer silencing	35	Dial a phonebook entry	51
Mount the telephone base (optional)	21	Mute the microphone	35	Edit a phonebook entry	51
Overview	22	Temporary tone dialing	36	Delete a phonebook entry	52
Handset	22	View dialing options	36	Delete all phonebook entries	52
Handset display icons	25	Join a call in progress	37	Redial list	53
Handset alert tones	26	Find handset	37	Review a redial list entry	53
Telephone base	27	Intercom	38	Redial a call from list	53
Telephone base display icons	30	Initiate an intercom call	38	Save a redial entry to the phonebook	54
Telephone base alert tones	30	Answer an incoming call during an intercom call	39	Delete a redial list entry	54
Operate	31	Transfer a call via intercom	40	Chain dialing	55
Make, answer or end a home call	31	Push-to-talk (PTT)	41	Access a number from the phonebook while on a call	55
Make a home call	31	Turn PTT on or off	42	Access a number from the caller ID log while on a call	55
Predial a home call	31	PTT call to a single device	42		
		PTT call to multiple devices	44		
		Answer a PTT call	45		
				Access a number from the redial list while on a call	55
				Caller ID	56
				Memory match	56
				Review the caller ID log	56
				Save a caller ID log entry to the phonebook	57
				Save a caller ID log entry to call block list	58
				Save a caller ID log entry to star name list	59
				Dial a caller ID log entry	59
				Delete caller ID entries	60
				Missed (new) call indicator	60
				Introducing Bluetooth®	61
				Glossary of terms	63
				VTech Connect to Cell™ application	64
				Bluetooth setup	64
				Add a cell phone	65
				Add a headset	66
				Auto connection	67
				Device list and connection	67
				Review the device list	67
				Connect/disconnect an active device	68
				Remove a paired device	68
				Download phonebook	69

Contents

Remote voice control	70	Screening announcements	85				
About Smart call blocker*	72	Record your name for screening announcements	85	Play your announcement	96	Message playback settings	106
What is Smart call blocker?	72	Reset screening announcements	86	Options during playback	96	Set remote access code	107
Welcome calls	73	Voice guide to set Smart call blocker	86	Delete your announcement	97	Screen calls Call screening	107
Unwelcome calls	73	Screened call options	87			Turn on or off the call screening	107
Unknown calls	73	Option while on a call	88	Configure Settings	98	Alert setting	108
SCB screening	74	Retrieve voicemail	89	Set languages	98	Turn on or off the message alert tone	108
No screening (default setting)	74	Answering system	89	Set voice language	98	Voicemail settings [Telephone service provider]	108
Screen unknown	75	Difference between the built-in answering system and voicemail service	89	Set date and time	99	Set speed dial voicemail number	108
Forward all unknown calls to answering system	76	Use your built-in answering system	90	Caller ID announce	99	Voicemail (visual message waiting) indicator	109
Block unknown calls	77	New message indication	90	Dial modes	100	Clear voicemail indicator/indication	109
Block list	78	Turn on or off the answering system	90	Set dial mode	100	Add and register handset	110
Add a block list entry	78	Playback messages	91	Temporary tone dialing	101	Screen messages	110
Review block list	79	Screen a call	93	Ringer	101	General product care	112
Save a caller ID log entry to block list	80	Call intercept while using answering system	93	Set number of rings	101	Taking care of your telephone	112
Edit a block list entry	80	Delete all messages	94	Set ringer tone	102	Avoid rough treatment	112
Unblock a telephone number	81	Record a memo	94	Set ringer volume	103	Avoid water	112
Delete all block list entries	81	Answering system remote access	95	Telephone base ringer volume	103	Electrical storms	112
Star name list	82	Announcement	96	Sound settings	104	Cleaning your telephone	112
Add a star name entry	82	Default announcement	96	Set listening volume	104		
Review star name list	83	Record your own announcement	96	Set key tone	104		
Save a caller ID log entry to star name list	83			Set QUIET mode	105		
Edit a star name entry	83			Answering system settings	105		
Delete a star name entry	84			Set your built-in answering system	105		
Delete all star name entries	84			Voice guide to set up answering system	106		

Technical specifications 113

- DECT 6.0 digital technology 113
- Telephone operating range 113
- Redefining long range coverage and clarity 113
- Simulated full-duplex handset and base speakerphones 114

Frequently asked questions 114

Disclaimer and Limitation of Liability 115

Install | Set up

What is in the box

Your telephone package contains the following items. Save your sales receipt and original packaging in case it is necessary to ship your telephone for warranty service.

NOTE

- To purchase replacement batteries or power adapters, visit our website at www.vtechphones.com or call 1 (800) 595-9511. In Canada, go to phones.vtechcanada.com or dial 1 (800) 267-7377.

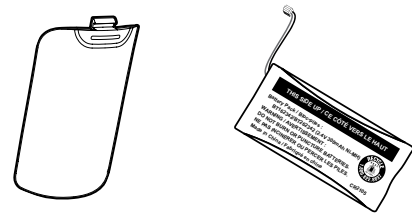
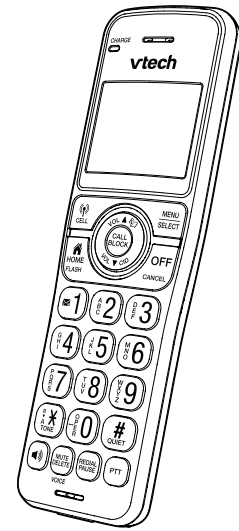

- 1 set for DS6951/VS306
- 2 sets for DS6951-2/VS306-2
- 3 sets for DS6951-3/VS306-3
- 4 sets for DS6951-4/VS306-4
- 5 sets for DS6951-5/VS306-5

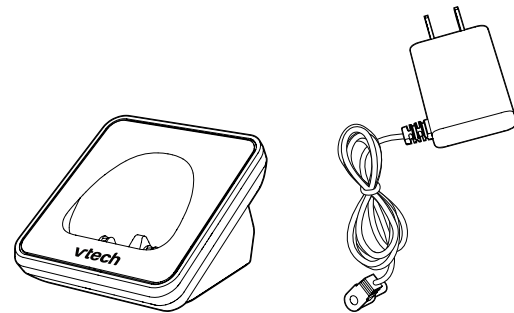
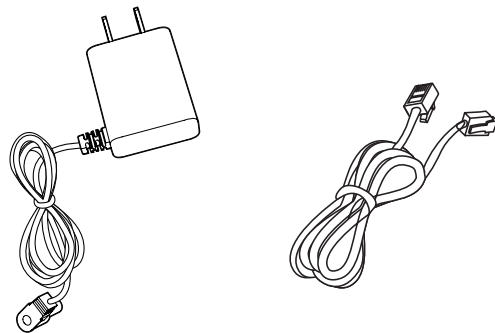
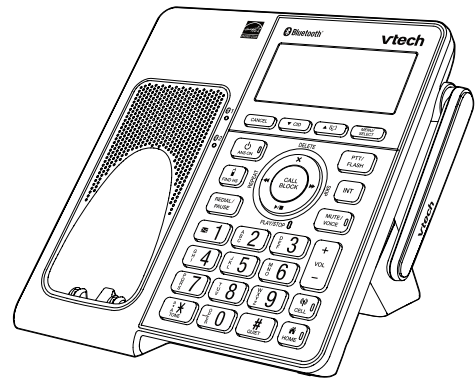

- 1 sets for DS6951-2/VS306-2
- 2 sets for DS6951-3/VS306-3
- 3 sets for DS6951-4/VS306-4
- 4 sets for DS6951-5/VS306-5

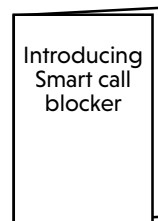
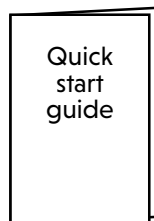

Install the battery

NOTES

- Use only the battery provided.
- Charge the battery provided with this product only in accordance with the instructions and limitations specified in this manual.
- If the handset will not be used for a long time, disconnect and remove the battery to prevent possible leakage.

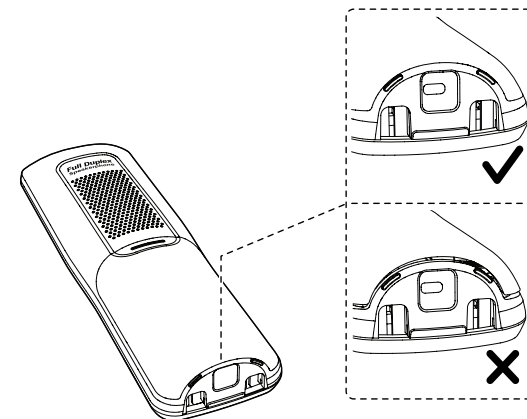
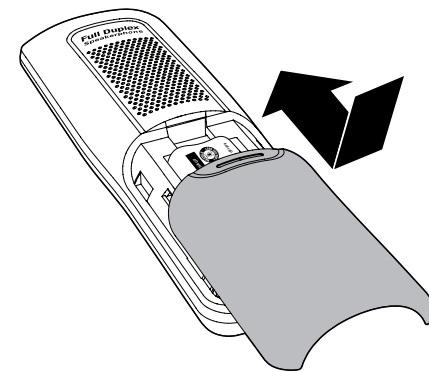
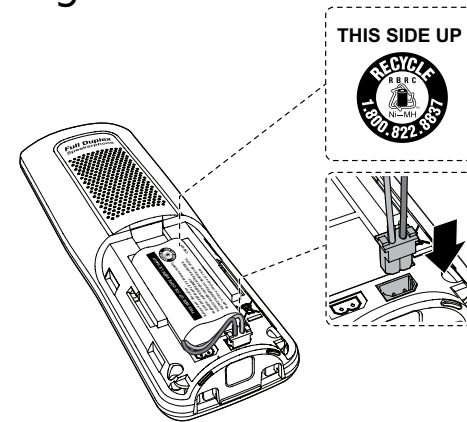

Connect the telephone base

NOTES

- Use only the adapters provided.
- Make sure the electrical outlets are not controlled by wall switches.
- The adapters are intended to be correctly oriented in a vertical or floor mount position. The prongs are not designed to hold the plug in place if it is plugged into a ceiling, under-the-table or cabinet outlet.

TIP

- If you subscribe to digital subscriber line (DSL) high-speed Internet service through your telephone line, make sure you install a DSL filter (not included) between the telephone line cord and telephone wall jack. Contact your DSL service provider for more information.

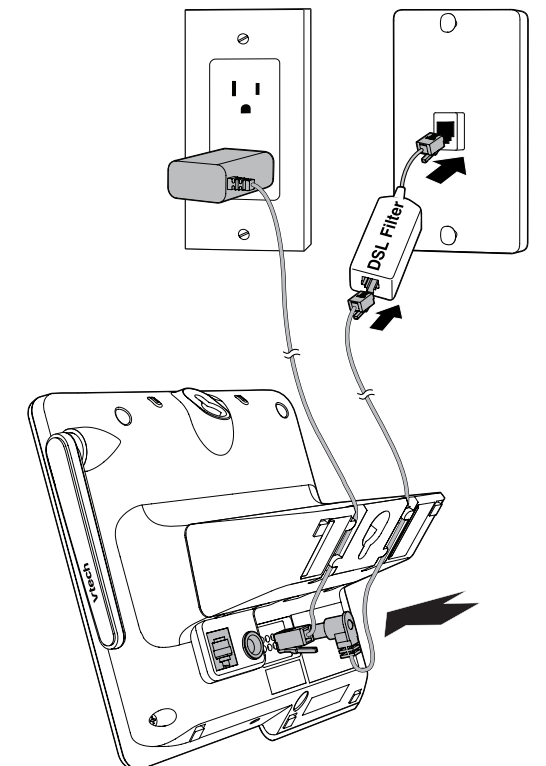

Connect the charger

NOTES

- Use only the adapters provided.
- Make sure the electrical outlets are not controlled by wall switches.
- The adapters are intended to be correctly oriented in a vertical or floor mount position. The prongs are not designed to hold the plug in place if it is plugged into a ceiling, under-the-table or cabinet outlet.

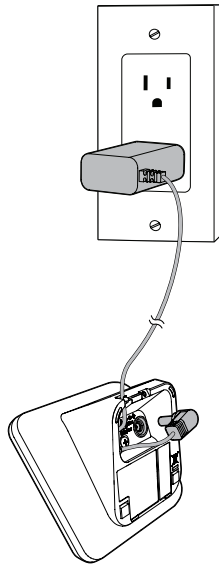

Charge the battery

Place the handset in the telephone base or charger to charge.

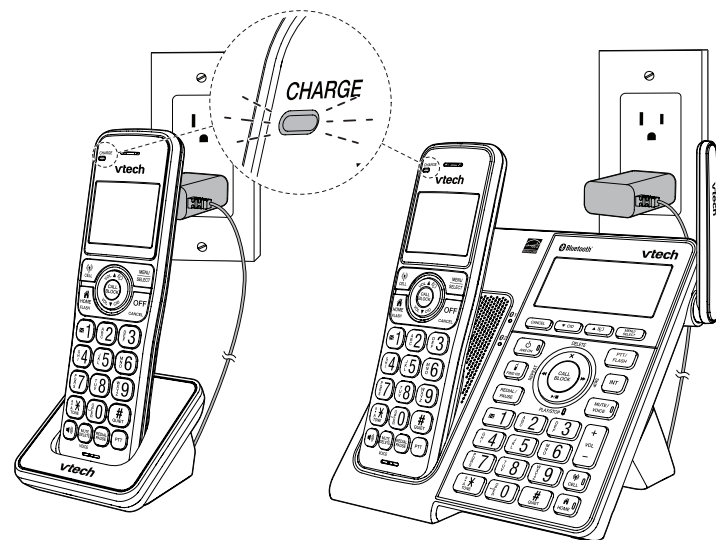

Once you have installed the battery, the handset LCD display indicates the battery status (see the table below).

Battery indicators	Battery status	Action
The screen is blank or shows Put in charger and flashes.	Battery has no charge or very little charge. The handset cannot be used.	Charge without interruption (at least 30 minutes).
The screen shows Low battery and flashes.	Battery has enough charge to be used for a short time.	Charge without interruption (at least 30 minutes).
The screen shows HANDSET X .	Battery is charged.	To keep the battery charged, place it in the telephone base or charger when not in use.

When it is fully charged, you can expect the following performance:

Operation	Operating time
While in handset use (talking*)	10 hours
While not in use (standby**)	5 days

* Operating times vary depending on your actual use and the age of the battery.

** Handset is not charging or in use.

NOTES

- Place the handset in the charger will bypass the set date and time, and voice guide.
- For best performance, keep the handset in the charger when not in use.
- The battery is fully charged after 16 hours of continuous charging.
- If you place the handset in the charger without plugging in the battery, the screen displays **NO BATTERY**.

Check the battery level

After you have installed the battery, check the battery level on the handset screen.

- If the battery icon is , or , then go to **Set the date and time**.
- If the screen is blank, or flashes, then the battery needs to be charged. Go to **Charge the battery** before you do any setting or operation.

Check for dial tone

Press **HOME/FLASH**. If you can hear a dial tone, the installation is successful.

If you do not hear a dial tone

- Make sure the installation procedures described above are properly done.
- It may be a wiring problem. If you have changed your telephone service to digital service from a cable company or a VoIP service provider, the telephone line may need to be rewired to allow all existing telephone jacks to work. Contact your cable/VoIP service provider for more information.

Before use

Set date and time

After you install your telephone or power returns following a power outage and battery depletion, the handset and telephone base will prompt you to set the date and time.

NOTE

- Make sure you set the date and time including the year correctly; otherwise the answering system does not announce the correct day of the week for your recorded messages time stamp.
1. Use the dialing keys (0-9) to enter the month (MM), date (DD) and year (YY). Then press **MENU/SELECT**.
 2. Use the dialing keys (0-9) to enter the hour (HH) and minute (MM). Then press ▼ or ▲ to choose **AM** or **PM**.
 3. Press **MENU/SELECT** to save.

After the setting for the date and time, the telephone base will prompt if you want to set Smart call blocker, and the answering system.

Set up Smart call blocker through Voice Guide (Before use)



This feature is an easy and alternative way for you to do the basic setup of Smart call blocker. You can follow the voice guide to set your telephone system to allow or to screen all incoming home calls, or to screen home calls that do not display a phone number.

1. Press **MENU/SELECT** to start the voice guide for the Smart call blocker setup. You hear the voice prompt *"Hello! This voice guide will assist you with the basic setup of Smart call blocker..."*
2. Set up your Smart call blocker feature by inputting the designated numbers, as instructed in the voice guide.
 - Press **1** if you want to screen home calls with telephone numbers that are not saved in your phonebook or star name list; or
 - Press **2** if you do not want to screen calls, and want to allow all incoming calls to get through.

NOTE

- Press **CANCEL** twice on the telephone base to quit the voice guide at any time.

Alternate way to set up

1. Press **CALL BLOCK** on the handset or telephone base to enter the call block menu when in idle mode.
- OR -
Press **MENU/SELECT** to enter the main menu when the handset is not in use. Then, press ▼CID or ▲ to scroll to **SCB settings**. Press **MENU/SELECT**.
2. Press ▼CID or ▲ to scroll to **Voice guide**, then press **MENU/SELECT**.
3. You hear a voice prompt *"Hello! This voice guide will assist you with the basic setup of Smart call blocker..."*
4. Set up your Smart call blocker feature by inputting the designated numbers, as instructed in the voice guide.
 - Press **1** if you want to screen home calls with telephone numbers that are not saved in your phonebook or star name list; or
 - Press **2** if you do not want to screen calls, and want to allow all incoming calls to get through.

NOTES

- The screening feature of Smart call blocker is applicable to home calls only. All incoming cell calls will get through and ring. If you want to block a cell call, add the number to the block list. See **Block list** section.
- You can press **CANCEL** on the telephone base to quit the voice guide at any time.

- After a power outage, the telephone base prompts you to set the date and time. After the date and time setting is done or skipped, the telephone base will prompt if you want to set up Smart call blocker via voice guide. Press **MENU/SELECT** to start the setup.

Set up Answering System through Voice Guide (Before use)

After the Smart call blocker setting is done or skipped, the telephone base will then prompt if you want to set up the answering system.

This feature assists you to do the basic setup of the answering system. You can follow the voice guide to record your own announcement, set the number of rings and the message alert tone.



1. Press **MENU/SELECT** to start the voice guide for the answering system setup. You hear the voice prompt *"This voice guide will assist you with the basic setup of your answering system."*
2. Setup your answering system by inputting the designated numbers as instructed in the voice guide.

NOTE

- To skip the answering system setup via voice guide, press **CANCEL** on the telephone base.

Alternate way to set up

This feature is an alternative way for you to do the basic setup of the answering system. You can follow the voice guide to record your own announcement, set the number of rings and the message alert tone.

1. Press **MENU/SELECT** on the telephone base in idle mode.
2. Press **▼CID** or **▲**  to scroll to **Answering sys**, and then press **MENU/SELECT**.
3. Press **▼CID** or **▲**  to scroll to **Voice guide**, then press **MENU/SELECT**. You hear the voice prompt *"This voice guide will assist you with the basic setup of your answering system."*
4. Set up your answering system by inputting designated numbers as instructed in the voice guide.

NOTES

- You can press **CANCEL** on the telephone base to quit the voice guide at any time.
- After a power outage, the telephone base prompts you to set the date and time, and Smart call blocker. After these settings are done or skipped, the telephone base then prompts if you want to set up the answering system via voice guide. Press **MENU/SELECT** to start the setup.

Install

Mount the telephone base (optional)

①

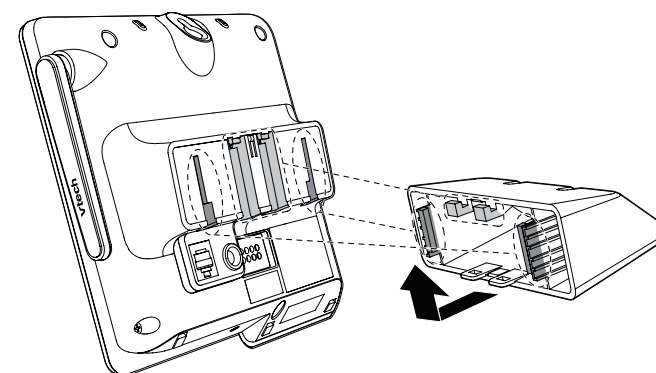

②

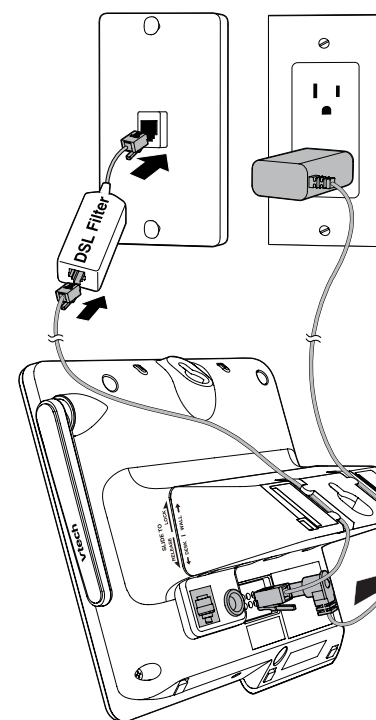

③

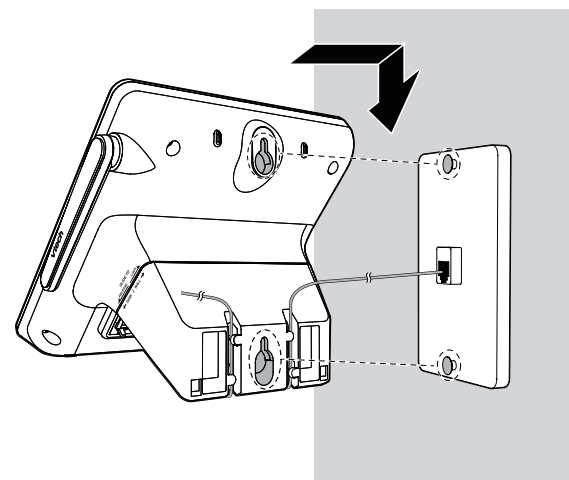

④



Operating range

This cordless telephone operates with the maximum power allowed by the Federal Communications Commission (FCC). Even so, this handset and telephone base can communicate over only a certain distance - which can vary with the locations of the telephone base and handset, the weather, and the layout of your home or office.

When the handset is out of range, the handset displays **Out of range** or **no pwr at base**.

If there is a call while the handset is out of range, it may not ring, or if it does ring, the call may not connect well when you press **HOME/FLASH**. Move closer to the telephone base, and then press **HOME/FLASH** to answer the call. If the handset moves out of range during a telephone conversation, there may be interference. To improve reception, move closer to the telephone base.

Overview

Handset

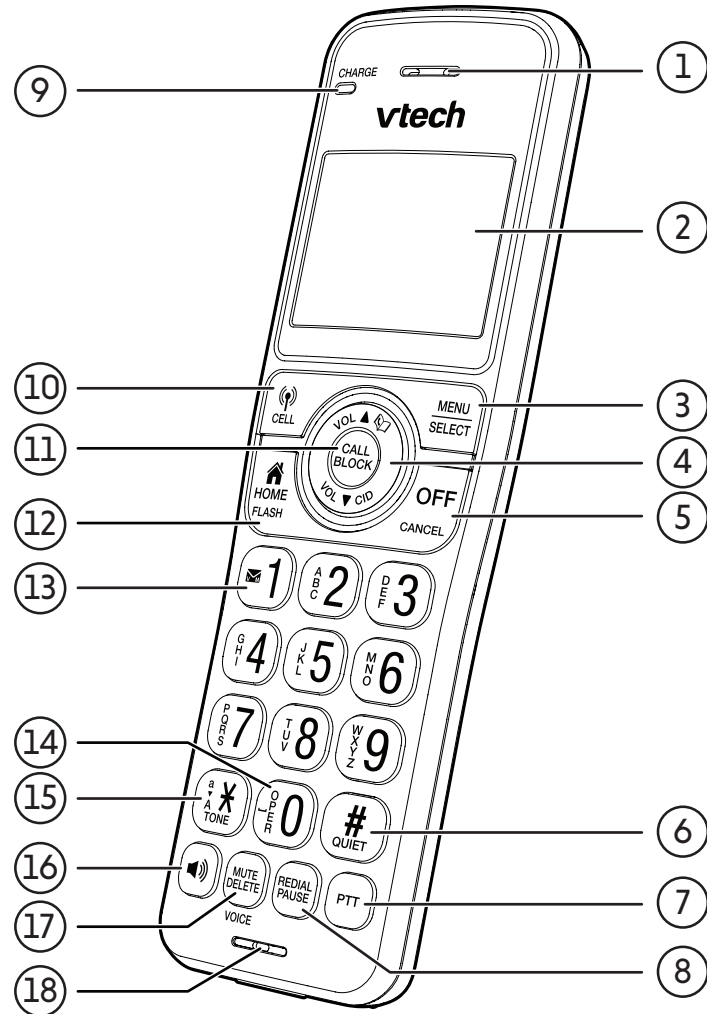

1 **Handset earpiece**

2 **LCD display**

3 **MENU
SELECT**

- Press to display the menu.
- Once in the menu, press to select an item or save an entry or setting.

4 **VOL▲ VOL▼/CID**

- Press to show phonebook entries when the telephone is not in use. Press to scroll up while in a menu.
 - Press to increase the listening volume when on a call, or increase the message playback volume.
 - While entering names or numbers, press to move the cursor to the right.
-
- Press to review the caller ID log when the telephone is not in use.
 - Press to scroll down while in a menu.
 - Press to decrease the listening volume when on a call, or decrease the message playback volume.
 - While entering names or numbers, press to move the cursor to the left.

5 **OFF
CANCEL**

- Hang up a call.
- Return to the previous menu or idle mode without making changes.
- Delete digits while predialing.
- Silence the handset ringer temporarily while the phone is ringing.
- Erase the missed call indicator while the handset is not in use.

6 **#
QUIET**

- Press and hold to set and turn on the QUIET mode, or turn it off.
- When reviewing a caller ID log entry, press repeatedly to view other dialing options.

7 **PTT (PUSH
TO TALK)**

- Press to initiate a one-to-one or one-to-group broadcast.
- Press and hold to broadcast to a group of system devices.

8 **REDIAL/
PAUSE**

- Review the redial list.
- Insert a dialing pause while dialing or entering numbers into the phonebook.

9 **CHARGE**





- On when the handset is charging in the telephone base or handset charger.

10 **CELL**

- Press to make or answer a cell call.
- During a cell call, press to answer an incoming cell call when you hear a call waiting alert.
- During message playback, press to call back the caller if the caller's number is available.

11 **CALL
BLOCK**

- Press to block the incoming call when the telephone is ringing.
- When on a call, press to block the call.
- When the handset is not in use, press to show the call block menu.

12		<ul style="list-style-type: none"> • Make or answer a home call. • Answer an incoming home call when you receive a call waiting alert. • During message playback, press to call back the caller if the caller's number is available.
13		<ul style="list-style-type: none"> • While reviewing a caller ID log entry, press repeatedly to add or remove 1 in front of the telephone number before dialing or saving it in the phonebook. • <u>Press and hold</u> to set or dial your voicemail number.
14		<ul style="list-style-type: none"> • Enter space character during text editing.
15		<ul style="list-style-type: none"> • Press to switch to tone dialing temporarily during a call if you have pulse service. • While entering names, press to change the next letter to upper or lower case.



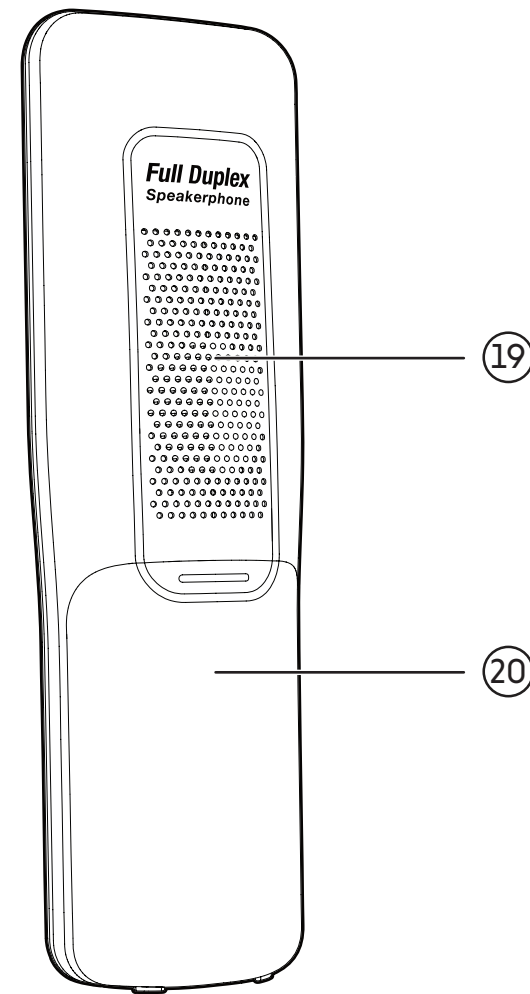





16		<ul style="list-style-type: none"> • Press to make or answer a home call or cell call using the speakerphone. • Press to turn on the handset speakerphone, press again to resume normal handset use.
17	MUTE/DELETE/VOICE	<ul style="list-style-type: none"> • During a call, press to Mute the microphone. • When the handset is ringing, press to mute the ringer temporarily. • While reviewing the caller ID log, the phonebook or the redial memory, press to delete an individual entry. • While predialing, press to delete digits. • During message or announcement playback, press to delete the playing message or the recorded announcement. • When the handset is not in use, press to activate the voice-controlled application of connected cell phone.
18	Microphone	



- 19 **Speakerphone**
- 20 **Battery compartment cover**

Handset display icons

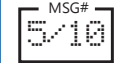

	The battery is low and needs charging.
	The battery is charging.
	The battery is fully charged.
	Handset ringer is off.
	New voicemail received from your telephone service provider.
<i>NEW</i>	There are new Caller ID log entries.
	Displays when Home line is in use.
	Bluetooth device is paired and active.
	Bluetooth device / Cell line is in use.
<i>ANS ON</i>	Answering system is on.
	Number of new/old messages recorded.
<i>ECO</i>	The ECO mode activates automatically to reduce power consumption when the handset is within range of the telephone base.

Handset alert tones

1 short beep	<ul style="list-style-type: none"> A key is pressed. Plays at the end of each message playback. End of recording.
1 long beep	<ul style="list-style-type: none"> Beginning of recording. Plays at the end of all messages playback.
2 short beeps	<ul style="list-style-type: none"> Error tone. The command has failed. You have reached the beginning or end of the list. You have reached the minimum or maximum listening volume.
3 short high-pitched beeps	<ul style="list-style-type: none"> Confirmation tone. The telephone has completed the command successfully.
4 short beeps	<ul style="list-style-type: none"> Low battery warning.

1	Antenna	
2	LCD display	<ul style="list-style-type: none"> Press to scroll up while in a menu. Press to show phonebook entries when the telephone is not in use. While entering names or numbers, press to move the cursor to the right.
3	▲ ▼ CID	<ul style="list-style-type: none"> Press to scroll down while in a menu. Press to review the caller ID log when the telephone is not in use. While entering names or numbers, press to move the cursor to the left.
4	MENU/ SELECT	<ul style="list-style-type: none"> When the telephone base is not in use, press to show the menu. While in the menu, press to confirm or save an entry or setting.

Telephone base

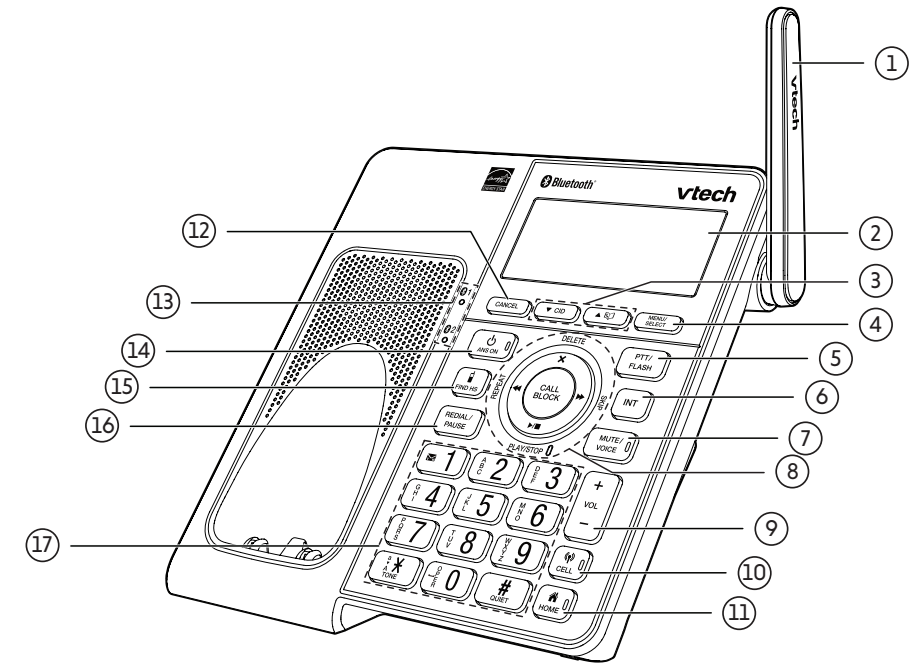

5	PTT/ FLASH	<ul style="list-style-type: none"> Press to display the PTT menu to begin a PTT call. Press and hold to begin a one-to-group broadcast when the telephone base is not in use. During a call, press to answer an incoming home call or cell call when you receive a call waiting alert.
6	INT	<ul style="list-style-type: none"> Press to initiate an intercom conversation or transfer a call.
7	MUTE/ VOICE	<ul style="list-style-type: none"> During a call, press to mute the microphone. While the telephone base is ringing, press to silence the ringer temporarily. When the telephone is not in use, press to activate the voice-controlled application of connected cell phone.

8	REPEAT	<ul style="list-style-type: none"> Press to repeat a message. Press twice to play the previous message.
	X / DELETE	<ul style="list-style-type: none"> Press to delete the message currently playing Press twice to delete all old messages when the telephone is not in use. While reviewing the redial list, phonebook, caller ID log, block list, or star name list, press to delete an individual entry. While entering names or numbers, press to delete a digit or a character. While predialing, press to delete a digits.
	SKIP	Press to skip a message.

8	PLAY/ STOP	<ul style="list-style-type: none"> Press to start or stop message playback. During call screening, press to temporarily turn the call screening on or off.
	CALL BLOCK	<ul style="list-style-type: none"> Press to block the incoming call when the telephone is ringing. When on a call, press to block the call. When the telephone base is not in use, press to show the call block menu.
	VOL -	<ul style="list-style-type: none"> Press to decrease the listening volume during a call. When the telephone is not in use, press to decrease the telephone base ringer volume.
9	VOL +	<ul style="list-style-type: none"> Press to increase the listening volume during a call. When the telephone is not in use, press to increase the telephone base ringer volume. During call screening or message playback, press to increase the listening volume.





10	CELL	<ul style="list-style-type: none"> Press to make or answer a cell call. Flashes quickly when there is an incoming cell call. Flashes slowly when a cell call is on hold.
	HOME	<ul style="list-style-type: none"> Press to make or answer a home call. Flashes quickly when there is an incoming home call. Flashes slowly when a home call is on hold.
11	CANCEL	<ul style="list-style-type: none"> While in a menu, press to exit without making changes or <u>press and hold</u> to return to idle mode. <u>Press and hold</u> while the telephone is not in use to erase the missed call indicator.
	1 Light	<ul style="list-style-type: none"> On when the telephone is paired and connected with a Bluetooth device. Flashes alternately while pairing a Bluetooth device.
12	2 Light	<ul style="list-style-type: none"> On when the telephone is paired and connected with a Bluetooth device or headset. Flashes alternately while pairing a Bluetooth device or headset.

14	ANS ON	Press to turn the built-in answering system on or off.
	FIND HS	<ul style="list-style-type: none"> Press the button to page all system handsets.
15	REDIAL/ PAUSE	<ul style="list-style-type: none"> Press repeatedly to view the last 10 numbers dialed. While entering numbers, <u>press and hold</u> to insert a dialing pause.
	1	<ul style="list-style-type: none"> While reviewing a caller ID log entry, press repeatedly to add or remove 1 in front of the telephone number before dialing or saving it in the phonebook. <u>Press and hold</u> to set or to dial your voicemail number.
16	TONE	<ul style="list-style-type: none"> Press to switch to tone dialing temporarily during a call if you have pulse service. While entering names, press to change the next letter to upper or lower case.
	0	<ul style="list-style-type: none"> Enter space character during text editing.

- Press repeatedly to display other dialing options when reviewing a caller ID log entry.
- Press and hold to enter the **QUIET** mode setting screen, or to deactivate **QUIET** mode.

Telephone base display icons



	Handset ringer is off.
	New voicemail received from your telephone service provider.
<i>NEW</i>	There are new Caller ID log entries.
	Displays when Home line is in use.
	Bluetooth device is paired and active.
	Bluetooth device / Cell line is in use.



Telephone base alert tones

1 short beep	<ul style="list-style-type: none"> • Plays at the end of each message playback.
Beeps every 10 seconds	<ul style="list-style-type: none"> • Message alert tone is on and there are new messages.
1 long beep	<ul style="list-style-type: none"> • Call screening is on and the answering system is about to • record a message. • Plays at the end of all messages playback.



Operate

Make, answer or end a home call



Make a home call

- Press  **HOME/FLASH** or  on the handset, then enter the telephone number.
- OR-
- Press  **HOME** on the telephone base, then enter the telephone number.

Predial a home call

- Enter the telephone number, then press  **HOME/FLASH** or  to dial.
- OR-
- Enter the telephone number using the telephone base, then press  **HOME** to dial.

Answer a home call

- Press  **HOME/FLASH** or  on the handset.
- OR-
- Press  **HOME** on the telephone base.

End a home call

- Press **OFF/CANCEL**, or put the handset in the telephone base or charger.
- OR-
- Press  **HOME** on the telephone base.

Using a Bluetooth headset to answer a home call:

You can use a Bluetooth headset to answer home calls. However, you need to keep the device within 15 feet of the telephone base for optimal performance. Please see the user's manual of your Bluetooth headset for more information.

To answer or end a home call using a Bluetooth headset:

- Press the call key on your headset.

NOTES

- The handset displays **Unable to call** if the telephone line is in use.
- The screen shows the elapsed time as you talk (in hours, minutes and seconds).
- When predialing (preview numbers before dialing), press **MUTE/DELETE/VOICE** on the handset to backspace and delete; press and hold **REDIAL/PAUSE** to insert a dialing pause (a **P** appears).

Make, answer or end a cell call

The **DS6951/DS6951-2/DS6951-3/DS6951-4/DS6951-5/VS306/VS306-2/VS306-3/VS306-4/VS306-5** can be used to make or answer calls on the cell line. You can connect a maximum of two Bluetooth enabled cell phones to the telephone base.

Make a cell call

1. Press **CELL** on the handset. The handset displays **Select a device**.
-OR-
Press **CELL** on the telephone base. The screen displays **SELECT A DEVICE**.
 - If you have only one cell phone connected to the telephone base, press **MENU/SELECT** to select the only device.
 - If you have two cell phones connected to the telephone, press **▼CID** or **▲** to select a cell phone and then press **MENU/SELECT**.
2. Enter the telephone number on the handset, then press **CELL** to dial.
-OR-
Enter the telephone number on the telephone base, then press **CELL** or **MENU/SELECT** to dial.

Predial a cell call

1. Enter the telephone number.
2. Press **CELL** on the handset to dial.
-OR-
Press **CELL** on the telephone base to dial.
 - If you have only one cell phone connected to the telephone base, it is automatically selected to make cell calls.
 - If you have two cell phones connected to the telephone base, the screen displays **Select a device**. Press **▼CID** or **▲** to select a cell phone and then press **MENU/SELECT**.

Answer a cell call

- Press **CELL** or **▶▶▶** on the handset.
- OR-**
- Press **CELL** on the telephone base.

End a cell call

- Press **OFF/CANCEL**, or put the handset in the telephone base or charger.
- OR-**
- Press **CELL** on the telephone base.

NOTES

- The screen displays **Unable to call** if your cell phone is in use.
- You can also use your cell phone to answer the call. If you answer with your cell phone, it disconnects from the telephone base.

- The screen shows the elapsed time as you talk (in hours, minutes and seconds).
- When predialing (preview numbers before dialing), press **MUTE/DELETE/VOICE** on the handset or telephone base to backspace and delete; press and hold **REDIAL/PAUSE** to insert a dialing pause (a **P** appears).
- Make a cell call using the cell lines of your telephone system instead of using the remote voice control feature, if you need to press dialing keys (**0-9**, **TONEX** or **QUIET#**) during a call.

Call waiting on the home line

If you subscribe to call waiting service from your telephone service provider, and someone calls while you are already on a call, the screen flashes **🏠**, and you hear a tone.





- Press **🏠 HOME/FLASH** on the handset, or press **PTT/FLASH** on the telephone base to put your current call on hold and take the new call.
- Press **🏠 HOME/FLASH** on the handset or press **PTT/FLASH** on the telephone base at any time to switch back and forth between calls.

NOTES

- If the Smart call blocker feature is on and in screening mode, and you receive a call waiting home call:
 - If you have already picked up a screened home call, the telephone checks whether the call waiting call's number can be found in the phonebook or block list. It also checks whether the caller name is in the star name list. After that, the telephone displays the caller ID information or **Blocked call** accordingly. You can press **🏠 HOME/FLASH** or **▶▶▶** to take the new call.
 - If the telephone is screening a home call, the call waiting call will be ignored and logged as missed call in the caller ID log.
- The screening feature of Smart call blocker is applicable to home calls only.

Call waiting on the cell line

If you subscribe to call waiting service from your cell phone service provider, and someone calls while you are already on a call on the cell line, the screen flashes , and you hear a beep.

- Press  **HOME/FLASH** on the handset, or press  **HOME** or **PTT/FLASH** on the telephone base to put your current call on hold and take the new call.
- Press  **HOME/FLASH** on the handset or press  **HOME** or **PTT/FLASH** on the telephone base at any time to switch back and forth between calls.

NOTES

- If the Smart call blocker feature is on and in screening mode, and you receive a call waiting cell call:
 - If you have already picked up a screened home call, the telephone checks whether the call waiting cell call's number can be found in the block list. If yes, the telephone displays **Blocked call** and rejects the call.
- The screening feature of Smart call blocker is applicable to home calls only.

Sound

Use speakerphone

Handset speakerphone

During a call, press ) to switch between the speakerphone and normal handset use.

Press **OFF/CANCEL**, or return the handset to the telephone base or charger to hang up.

Control volume

While on a call or message playback, you can adjust the listening volume on the handset or telephone base.

If it is a cell call and the volume is too loud, too quiet or drops out, try changing the volume on your cell phone. On some cell phones, changing the volume on the cell phone affects your cell call volume on the **DS6951/DS6951-2/DS6951-3/DS6951-4/DS6951-5/VS306/VS306-2/VS306-3/VS306-4/VS306-5** handsets.

To adjust the listening volume of a handset:



- Press **VOL ▲** or **VOL ▼** on the handset while on a call.

To adjust the listening volume of the telephone base:

- Press **VOL +** or **VOL -** while listening to the message playback on the telephone base.

Temporary ringer silencing

When the telephone is ringing, you can temporarily silence the ringer of the handset or telephone base without disconnecting the call. The next call rings normally at the preset volume.

- Press **OFF/CANCEL** or **MUTE/DELETE/VOICE** on the handset. The handset screen shows **Ringer muted** and .
- OR -
Press **CANCEL** or **MUTE/VOICE** on the telephone base. The screen shows **Ringer muted** and .

NOTE

- Each handset and the base ring when there is an incoming call unless the ringer volume of that device is turned off.

Mute the microphone

The mute function allows you to hear the other party but the other party cannot hear you.

To mute a call:

- While on a call, press **MUTE/DELETE/VOICE** on the handset or **MUTE/VOICE** on the telephone base. The screen displays **Muted** until the mute function is turned off.

To end mute a call:

- Press **MUTE/DELETE/VOICE** on the handset or **MUTE/VOICE** on the telephone base again and resume speaking. The screen briefly displays **Microphone on**.

Mute is automatically canceled when you end the call.

Temporary tone dialing

If you have pulse (rotary) service only, you can switch from pulse to touch-tone dialing temporarily during a call. This is useful if you need to send touch-tone signals to access your telephone banking or long distance services.

During a call:

1. Press **TONEX** on the handset.
2. Use the dialing keys to enter the relevant number. The telephone sends touch-tone signals.
3. The telephone automatically returns to pulse dialing after you end the call.

View dialing options

Though the caller ID log entries have 10 digits (the area code plus the seven-digit number), in some areas, you may dial 1 plus the area code plus the seven digits. You can change the number of digits that you dial from or store to the phonebook.

While reviewing the caller ID log, press **#** QUIET (pound key) repeatedly to display different dialing options for local and long distance numbers before dialing or saving the telephone number in the phonebook.



Press **1** repeatedly if you need to add or remove 1 in front of the telephone number before dialing or saving it in the phonebook.

NOTE

- 7-digit local dialing will be invalid from October 2021 onwards. Press # (pound key) repeatedly to select the appropriate dialing option.

Join a call in progress

Another handset or the telephone base can join you on home call. The call continues until all parties hang up. You can share an outside call with up to two system devices.

- When a handset or telephone base is already on a call, press  **HOME/FLASH** or  on another handset to join the call.

-OR-

When a handset is already on a call, press  **HOME** on the telephone base to join the call.

- Press **OFF/CANCEL** or place the handset in the telephone base or handset charger to exit the call. The call continues on the other handset until both handsets hang up.

-OR-

Press  **HOME** on the telephone base to exit the call. The call continues on the other handset until both devices hang up.

NOTE

- If you have paired a DECT 6.0 cordless headset to the telephone base, you can also join a call in progress using the paired device. Refer to the user's manuals of the respective product for more information.

Find handset

This feature helps you find all system handsets.

CAUTIONS

- Do not press and hold  **FIND HS** for more than four seconds. It may lead to handset deregistration.
- If the handset displays **To register HS...** and **...see manual**, refer to **Frequent asked questions** to register the handset back to the telephone base.

To start paging

- Press  **FIND HS** on the telephone base when it is not in use. All idle handsets ring and display ****Paging****.

To end paging

Press  **HOME/FLASH**,  **CELL**, **OFF/CANCEL** or  on the handset.

-OR-

- Press  **FIND HS** again on the telephone base.

-OR-

- Place the handset in the handset charger.

NOTE

- If you press **MUTE/DELETE/VOICE** on a handset, the ringer of that handset is silenced but the paging tone continues on the other handsets.

Intercom

Use the intercom feature for conversations between two devices.

You can register up to five handsets to the telephone base.

Initiate an intercom call

Using a cordless handset

1. Press **MENU/SELECT** on the handset in idle mode.
2. Press **▼CID** or **▲📖** to highlight **Intercom**, then press **MENU/SELECT**.
3. Press **▼CID** or **▲📖** to select a device. The handset shows **Calling HS X** or **Calling Base** (X represents the handset number). The destination handset rings and shows **HS X is calling**.

To answer an intercom call with the cordless handset:

- Press **🏠 HOME/FLASH**, **📶 CELL**, **OFF/CANCEL** or **🔊** on the handset. Both devices now show **Intercom**.

To end an intercom call with the cordless handset:

- Press **OFF/CANCEL** or place the handset back in the telephone base or charger.

Using the telephone base

1. Press **INT** on the telephone base.
-OR-
Press **MENU/SELECT** on the telephone base in idle mode, then press **▼CID** or **▲📖** to highlight **Intercom**. Press **MENU/SELECT**.
2. Press **▼CID** or **▲📖** to select a device. The telephone base shows **Calling HS X** (X represents the handset number). The destination handset rings and shows **Base is calling**.

To answer an intercom call with the telephone base:

- Press **🏠 HOME** or **📶 CELL** on the telephone base. Both devices now show **Intercom**.

To end an intercom call with the telephone base:

- Press **CANCEL** on the telephone base.

NOTES

- To cancel the intercom call before it is answered, press **OFF/CANCEL** on the handset, or press **CANCEL** or **INT** on the telephone base.
- If the destination device does not answer the intercom call within 100 seconds, or if the device is in use, on a call, or out of range, the initiating telephone base displays **No answer, try again**, or the initiating handset displays **Unable to call**, and returns to idle mode.

- To temporarily silence the intercom ringer, press **OFF/CANCEL** or **MUTE/DELETE/VOICE** on the destination handset/headset, or press **CANCEL** on the telephone base.
- You can only use one pair of devices at a time to make intercom calls.

Answer an incoming call during an intercom call

If you receive an incoming home call during an intercom call, you will hear an alert tone. Handsets and telephone base flash **🏠** and display the caller ID.

If you receive an incoming cell call during an intercom call, you will hear an alert tone. Handsets and telephone base flash **📶** and display the caller ID.

To answer a home call during an intercom call using the cordless handset:

- Press **🏠 HOME/FLASH** to answer the home call and the intercom call ends automatically.
- Press **OFF/CANCEL** to end the intercom call. The telephone continues to ring. Then, press **🏠 HOME/FLASH**.
- To end the intercom call without answering the outside call, press **OFF/CANCEL**. The intercom call ends and the telephone continues to ring.

To answer a cell call during an intercom call using the cordless handset:

- Press **📶 CELL** to answer the cell call and the intercom call ends automatically.
- Press **OFF/CANCEL** to end the intercom call. The telephone continues to ring. Then, press **📶 CELL**.
- To end the intercom call without answering the outside call, press **OFF/CANCEL**. The intercom call ends and the telephone continues to ring.

To answer a home call during an intercom call using the telephone base:

- Press **🏠 HOME** to answer the home call and the intercom call ends automatically.
- Press **CANCEL** to end the intercom call. The telephone continues to ring. Then, press **🏠 HOME**.
- To end the intercom call without answering the outside call, press **CANCEL**. The intercom call ends and the telephone continues to ring.

To answer a cell call during an intercom call using the telephone base:

- Press **CELL** to answer the cell call and the intercom call ends automatically.
- Press **CANCEL** to end the intercom call. The telephone continues to ring. Then, press **CELL**.
- To end the intercom call without answering the outside call, press **CANCEL**. The intercom call ends and the telephone continues to ring.

Transfer a call via intercom

While on an outside call, you can use the intercom feature to transfer the call from one device to another.

Using a cordless handset

1. When on an outside call, press **MENU/SELECT**.
 2. Press **▼CID** or **▲** to highlight **Intercom**, then press **MENU/SELECT**. The call is automatically put on hold.
 3. Press **▼CID** or **▲** to select a device. The handset shows **Calling base** or **Calling HS X** (X represents the handset number). The destination device rings and shows **HS X is calling**.
 4. To answer the intercom call on the other handset, press **HOME/FLASH**, **CELL** or **CELL** on the destination handset. The outside call is still on hold. Both devices now show **Intercom**.
- OR-**

To answer the intercom call on the telephone base, press **HOME** or **CELL** on the telephone base. The outside call is still on hold. Both devices now show **Intercom**.

5. To transfer the call, press **OFF/CANCEL** or place the handset back in the telephone base or charger. The other handset automatically connects to the outside call.

-OR-

The called party can end the intercom call by pressing **OFF/CANCEL** or by placing the other handset back in the telephone base or charger. The outside call continues with the originating handset.

Using the telephone base

1. When on an outside call, press **INT** on the telephone base.
- OR-**
- When on an outside call, press **MENU/SELECT** on the telephone base, then press **▼CID** or **▲** to highlight **Intercom**. Press **MENU/SELECT**.
 2. The call is automatically put on hold. Press **▼CID** or **▲** to select a device. The screen shows **Calling HS X** (X represents the handset number). The destination device rings and shows **Base is calling**.
 3. To answer the intercom call on the other device, press **HOME/FLASH**, **CELL** or **CELL** on the destination handset. The outside

call is still on hold. Both devices now show **Intercom**.

- To transfer the call, press **MENU/SELECT** on the telephone base, and then scroll to **Transfer**, then press **MENU/SELECT**. The other handset automatically connects to the outside call.

-OR-

- The called party can end the intercom call by pressing **CANCEL** on the telephone base. The outside call continues with the telephone base.

NOTES

- If you want to cancel an intercom call and reconnect to the outside call before the destination handset answers, press **OFF/CANCEL** on the originating handset or press **CANCEL** on the originating telephone base.
- If the called device does not answer the intercom call within 100 seconds, or if the device is in use, on a call or out of range, the initiating telephone base displays **No answer, try again**, or the initiating handset displays **Unable to call**, and returns to the outside call.
- You can press **OFF/CANCEL** or **MUTE/DELETE/VOICE** on the destination handset, or press **CANCEL** on the telephone base to temporarily silence the intercom ringer.
- Only one intercom call can be established at a time.

Push-to-talk (PTT)

You can directly broadcast messages to the speakerphone of any device. Press and hold PTT on a handset or **PTT/FLASH** on the telephone base to begin two-way communication.

- Only one device can talk at a time. While talking to another device, press and hold PTT on the handset or **PTT/FLASH** on the telephone base.
- You must release **PTT** on the handset or **PTT/FLASH** on the telephone base, so the other person can respond.
- Only one PTT session can be active at a time.
- While PTT is in use between two devices, other devices cannot use the intercom feature but can access the answering system.
- When you attempt to place a PTT call to another device which is accessing the answering system or on an intercom call or outside call, your device screen shows **Not available**.

NOTE

- The PTT function is not available when **QUIET** mode is on.

Turn PTT on or off

Using a cordless handset:

1. Press **PTT** when the handset is not in use. The **PUSH TO TALK** menu displays.
2. Press **▼CID** or **▲** to highlight **PTT On/Off**, then press **MENU/SELECT**.
3. Press **▼CID** or **▲** to choose **On** or **Off**, then press **MENU/SELECT**.

Using the telephone base:

1. Press **PTT/FLASH** when the telephone base is not in use. The **PUSH TO TALK** menu displays.
2. Press **▼CID** or **▲** to highlight **PTT On/Off**, then press **MENU/SELECT**.
3. Press **▼CID** or **▲** to choose **On** or **Off**, then press **MENU/SELECT**.

NOTE

- The handset or the telephone base screen displays **No Incoming PTT** when PTT is turned off.

PTT call to a single device

Using a cordless handset:

1. There are a few ways to begin a PTT call to a single device. When the handset is not in use:
 - If you have one handset, press and hold PTT.
 - If you have more than one handset:
 - Press **PTT** on the handset, then use the dialing keys to enter the destination device number.

-OR-

- Press **PTT** on the handset. Press **▼CID** or **▲** to highlight the destination device number, then press **MENU/SELECT** or **PTT**.

The handset shows **Connecting HS X** (**HS** represents the handset name, **X** represents the destination handset number) or **Connecting BS** (**BS** represents the base name) for a few seconds. When the connection is made, both your and the destination device screens display **Press [PTT] Talk**.

2. Press and hold PTT. A chirp indicates your microphone is on. Speak towards the device. Your voice is broadcast to the destination device. While you are speaking, your handset shows **PTT To handset: X** or **PTT To base**.
3. Release **PTT** after speaking. Both devices beep once again and the screens show **Press [PTT] Talk**, then you can press and hold PTT to continue

speaking or the destination device can respond (see **Answer a PTT call**).

4. To end the PTT call, press **OFF/CANCEL** or place the handset in the telephone base or charger. The handset shows **PTT ended**.

Using the telephone base:

1. There are a few ways to begin a PTT call to a single handset. When the telephone base is not in use:
 - If you have one handset, press and hold PTT/FLASH.
 - If you have more than one handset:
 - Press **PTT/FLASH**, then use the dialing keys to enter the destination handset number.

-OR-

- Press **PTT/FLASH**. Press **▼CID** or **▲** to highlight the destination handset number, then press **MENU/SELECT** or **PTT/FLASH**.

The telephone base shows **Connecting to HANDSET X...** (**HANDSET** represents the handset name, **X** represents the destination handset number) for a few seconds. When the connection is made, both the telephone base and destination handset display **Press and hold [PTT] to talk**.

2. Press and hold PTT/FLASH. A chirp indicates your microphone is on. Speak towards the telephone base. Your voice is broadcast to the destination handset. While you are speaking, the telephone base shows **PTT To handset: X**.
3. Release **PTT/FLASH** after speaking. Both devices beep once again and the screens show **Press and hold [PTT] Talk**, then you can press and hold PTT/FLASH to continue speaking or the destination device can respond (see **Answer a PTT call**).
4. To end the PTT call, press **CANCEL**. The telephone base shows **Push to talk Ended** for a few seconds.

PTT call to multiple devices

When there are multiple handsets registered to the phone system, PTT supports one-to-group calls. PTT supports a maximum of one-to-five calls when one to five handsets are registered, and a maximum of one-to-four calls when six or more handsets are registered. The first four registered handsets will be able to use this feature. Other handsets can only use PTT for one-to-one calls.

Using a cordless handset:

1. You have three ways to call multiple devices. When the handset is not in use:
 - Press and hold PTT until the handset shows **Connecting All**.
 - Press **PTT**. Press **▼CID** or **▲** to choose **PTT to all**. Press **MENU/SELECT** or press **PTT** and your handset shows **Connecting All**.When the connection is made, both the caller and the destination parties hear a beep. The speakerphones on all other devices automatically activate.
2. You need to press and hold PTT when you want to speak. Speak towards the handset. Your voice is broadcast to all devices.
3. Release **PTT** after speaking.
4. Any extension can reply (see [Answer a PTT call](#)).

Using the telephone base:

1. You have three ways to call multiple handsets. When the telephone base is not in use:
 - Press and hold PTT/FLASH until the screen shows **Connecting to group...**
 - Press **PTT/FLASH**. Press **▼CID** or **▲** to choose **Group**. Press **MENU/SELECT** or press **PTT/FLASH** and the telephone base shows **Connecting to group...**When the connection is made, both the caller and the destination parties hear a beep. The speakerphones on all other devices automatically activate.
2. You need to press and hold PTT/FLASH when you want to speak. Speak towards the telephone base. Your voice is broadcast to all devices.
3. Release **PTT/FLASH** after speaking.
4. Any extension can reply (see [Answer a PTT call](#)).

NOTE

- After **PTT** on the handset or **PTT/FLASH** on the telephone base is released, the PTT call remains open for a short time. If no one presses **PTT** on the handset or **PTT/FLASH** on the telephone base within ten seconds, the PTT call ends automatically.

Answer a PTT call

You can respond to a PTT call, as described below.

1. When your device receives a PTT call, it beeps and shows **Press and hold [PTT] to talk** on the telephone base, or **Press [PTT] Talk** on the handset.
2. When the other party is speaking, the handset speakerphone light is on, and your device shows:
 - **PTT From HS X** (X represents the handset number) or **PTT From Base**.
3. When your handset speakerphone light is off (the screen shows **Press [PTT] Talk**), press and hold PTT on your handset or **PTT/FLASH** on your telephone base. You will hear a chirp. Speak towards the device.
 - While you are speaking, your device shows **PTT To Handset: X** (X represents the handset numbers of one or more destination handsets; a maximum of five handset numbers appear) or **PTT To Base & Handset: X** (X represents the handset numbers of one or more destination handsets; a maximum of four handset numbers appear)
 - Your voice is broadcast to all destination devices.

After speaking, release **PTT** on your handset or **PTT/FLASH** on your telephone base. Your device will beep. After the beep, if your speakerphone light is off, you can press and hold PTT on your handset or **PTT/FLASH** on your telephone base to continue speaking, or the destination device can respond.

Change a one-to-one PTT call to an intercom call

You can convert a one-to-one PTT session to an intercom call.

1. When your device shows **Press [PTT] Talk**, press **MENU/SELECT**. The screen shows **Intercom**.
2. Press **MENU/SELECT**. Your device displays **Calling base** or **Calling HS X**. The destination device shows **HANDSET X is calling** or **BASE 0 is calling**. The destination device rings.
3. Press **HOME/FLASH**, **CELL**, or **CELL** on the destination handset, or press **HOME** or **CELL** on the telephone base to answer the intercom call. Both devices now show **Intercom**.
4. To end the intercom call, press **OFF/CANCEL** on your handset or place the handset in the telephone base or charger, or press **CANCEL** on the telephone base. Both screens show **Intercom ended**.

Answer an incoming call during a PTT call

When you receive an outside call during PTT, there is an alert tone.

- During a one-to-one PTT, press **HOME/FLASH**, **CELL**, or **PHONE** on the initiating or destination handset. The PTT call ends automatically and the outside call is answered.
- During a one-to-group PTT call, press **HOME/FLASH**, **CELL**, or **PHONE** on the initiating handset, or **HOME** on the initiating telephone base. The PTT call ends automatically and the outside call is answered.
- During a one-to-group PTT call, press **HOME/FLASH** on any one of the destination handsets, or press **HOME** on the destination telephone base. That device answers the outside call. The PTT call continues for the rest of the PTT participants.
- To leave the PTT call without answering the incoming call, press **OFF/CANCEL** on your handset or **CANCEL** on your telephone base. The telephone continues to ring.

Make an outgoing call during PTT call

- During a one-to-one PTT call, press **HOME/FLASH** on your handset or **HOME** on your telephone base to get a dial tone. The PTT call ends automatically.
- During a one-to-group PTT call, press **HOME/FLASH** on the initiating handset or **HOME** on the initiating telephone base. The PTT call ends automatically and you get a dial tone.
- During a one-to-group PTT call, press **HOME/FLASH** on any one of the destination handsets or press **HOME** on the destination telephone base. That device gets a dial tone. The PTT call continues for the rest of the PTT participants.

End or leave a PTT call

For one-to-one PTT calls, both initiating and destination devices can end the PTT call. For PTT calls to multiple devices, the initiating device can end the PTT call. If any one of the destination devices leaves the PTT call, the call continues until all participants or the initiator hangs up.

Press **OFF/CANCEL** on the handset, or press **CANCEL** on the telephone base.

The screen shows **Push to talk Ended**.

-OR-

Place the handset in the telephone base or charger, then the handset returns to idle mode.

NOTE

- After **PTT** on the handset or **PTT/FLASH** on the telephone base is released, the PTT call remains open for a short time. If no one presses **PTT** on the handset or **PTT/FLASH** on the telephone base within ten seconds, the PTT call ends automatically.

Use the phone menu

1. Press **MENU/SELECT** when the phone is not in use.
2. Press **▼CID** or **▲BOOKMARKS** until the screen displays the desired feature menu.
3. Press **MENU/SELECT** to select and enter the menu.
 - To return to the previous menu, press **OFF/CANCEL** on the handset or **CANCEL** on the telephone base.
 - To return to idle mode, press and hold **OFF/CANCEL** on the handset or **CANCEL** on the telephone base.

Phonebook

The phonebook stores up to 1,200 entries with up to 30 digits for each phone number and 15 characters for each name.

- Phonebook entries are stored at the telephone base and shared by all system handsets. Any changes made on one handset apply to all.
- Only one handset can review the phonebook at a time. If another handset tries to enter the phonebook, its screen shows **Not available**.
- When there are no records in the phonebook, the screen shows **List empty**.
- When you try to save a number already stored in the phonebook, the screen shows **Number repeated**.
- Phonebook entries can also be saved to the block list. See **Block list**.
- When Smart call blocker is on, calls with numbers saved in the phonebook will get through and ring on your telephone. If a number saved in the phonebook is also saved in the block list, calls from this number will be blocked.

Add a phonebook entry

1. Press **MENU/SELECT** on the handset or telephone base in idle mode.
 2. Press **▼CID** or **▲** to highlight **Phonebook**, then press **MENU/SELECT**.
 3. Press **MENU/SELECT** on the handset again to choose **Add new entry**, or press **▼CID** or **▲** on the telephone base to highlight **Add new entry**, then press **MENU/SELECT**.
 4. When the screen shows **Enter number**, use the dialing keys to enter a telephone number (up to 30 digits).
 - Press **▼CID** or **▲** to move the cursor to the left or right.
 - Press **MUTE/DELETE/VOICE** on the handset or **X/DELETE** on the telephone base to erase a digit.
 - Press and hold **MUTE/DELETE/VOICE** on the handset or **X/DELETE** on the telephone base to erase all digits.
 - Press and hold **REDIAL/PAUSE** to insert a three-second dialing pause (a **P** appears).
- OR-**
- Press **REDIAL/PAUSE** to copy a number from the redial list. Press **▼CID** or **▲**, or press **REDIAL/PAUSE** repeatedly to locate the desired number. Press **MENU/SELECT** to copy the displayed number.
5. Press **MENU/SELECT** to move on to the name.

6. Use the dialing keys to enter a name (up to 15 characters) when prompted. Press a key repeatedly until the desired character shows on the screen.
 - Press **▼CID** or **▲** to move the cursor to the left or right.
 - Press **0** to add a space.
 - Press **MUTE/DELETE/VOICE** on the handset or **X/DELETE** on the telephone base to erase a character.
 - Press and hold **MUTE/DELETE/VOICE** on the handset or **X/DELETE** on the telephone base to erase all characters.
 - Press **TONEX** to change the next letter to upper or lower case.
7. Press **MENU/SELECT** to store your new phonebook entry.

Add a predialed telephone number to the phonebook

1. While the telephone is not in use, use the dialing keys to enter the telephone number (up to 30 digits).
 - Press and hold **REDIAL/PAUSE** to insert a three-second dialing pause (a **P** appears).
 - Press **MUTE/DELETE/VOICE** on the handset or **X/DELETE** on the telephone base to erase a digit.
 - Press and hold **MUTE/DELETE/VOICE** on the handset or **X/DELETE** on the telephone base to erase all digits.
2. Press **MENU/SELECT** twice to move on to edit the name. Refer to Step 6 in **Add a phonebook entry** section.
3. Press **MENU/SELECT** to store your new phonebook entry. You hear a confirmation tone.

Review the phonebook entries

Entries are sorted alphabetically.

1. Press on the handset or telephone base when in idle mode. The screen shows the first entry in the phonebook. List empty appears if there are no phonebook entries.
2. Press **▼CID** or to browse through the phonebook or use the dialing keys to start a name search.

-OR-

1. Press **MENU/SELECT** when in idle mode.
2. Press **▼CID** or to scroll to **Phonebook**, then press **MENU/SELECT**.
3. Press **▼CID** or to scroll to **Review**, then press **MENU/SELECT**. The screen shows the first entry in the phonebook.
4. Press **▼CID** or to browse through the phonebook. Entries appear alphabetically by the first letter in the name.

NOTES

- If the telephone number in the phonebook exceeds 15 digits, - appears in front of the telephone number and shows the remaining numbers alternately.
- You hear a double beep when you reach the beginning or end of the phonebook.

Search by name

1. Press when the handset is in idle mode.
2. When an entry appears, use the dialing keys (**0-9**) to start a name search (alphabetical search).

The phonebook shows the first name beginning with the first letter associated with the dialing key, if there is an entry in the phonebook that begins with that letter. Press **▼CID** or to scroll through the entries beginning with that letter.

3. To see other names that start with the letters on the same dialing key, keep pressing the key until the desired letter is shown. The names appear in alphabetical order.

For example, if you have the names Jennifer, Jessie, Kevin and Linda in your phonebook:

- If you press **5 (JKL)** once, **J** and then **Jennifer** displays.
- If you press **5 (JKL)** once, **J** displays. Press **▼CID**. **Jessie** displays.
- If you press **5 (JKL)** twice, **K** and then **Kevin** displays.
- If you press **5 (JKL)** three times, **L** and then **Linda** displays.
- If you press **5 (JKL)** four times, **5** displays.
- If you press **5 (JKL)** five times, **J** displays and then **Jennifer** displays again.

Dial a phonebook entry

You can dial a phonebook entry on either a home or cell line.

1. Search for the desired entry in the phonebook (see **Review the phonebook entries** or **Search by name**).
2. When the displayed number is in the correct format, press **HOME/FLASH** or on the handset or **HOME** on the telephone base to dial with the home line.

- OR -

Press **CELL** on the handset or telephone base to dial with the cell line.

Edit a phonebook entry

1. While reviewing a phonebook entry, press **MENU/SELECT**. The screen shows **Enter number** with the current number of the entry.
2. Use the dialing keys to edit the number (up to 30 digits).
 - Press **▼CID** or to move the cursor to the left or right.
 - Press **MUTE/DELETE/VOICE** on the handset or **X/DELETE** on the telephone base to erase a digit.
 - Press and hold **MUTE/DELETE/VOICE** on the handset or **X/DELETE** on the telephone base to erase all digits.
 - Press and hold **REDIAL/PAUSE** to insert a three-second dialing pause (a **P** appears).

-OR-

Copy a number from the redial list by pressing **REDIAL/PAUSE** and then **▼CID** or , or pressing **REDIAL/PAUSE** repeatedly to locate the desired number. Press **MENU/SELECT** to copy the displayed number.

3. Press **MENU/SELECT** to save the number. The screen shows **Enter name** briefly and then the current name of the entry.
4. Edit the characters.
 - Press **▼CID** or to move the cursor to the left or right.
 - Press **0** to add a space.

- Press **MUTE/DELETE/VOICE** on the handset or **X/DELETE** on the telephone base to erase a character.
 - Press and hold **MUTE/DELETE/VOICE** on the handset or **X/DELETE** on the telephone base to erase all characters.
5. Press **MENU/SELECT** to save. The handset shows the updated entry.

Delete a phonebook entry

1. While reviewing a phonebook entry, press **MUTE/DELETE/VOICE** on the handset. The screen shows **Delete entry?**
- OR -
While reviewing a phonebook entry, press **X/DELETE** on the telephone base. The screen shows **Delete contact?** and the contact name.
2. Press **MENU/SELECT** to delete the displayed entry from the phonebook. The handset shows **Deleting...** and then you hear a confirmation tone. Once deleted, you cannot retrieve that entry.

Delete all phonebook entries

1. Press **MENU/SELECT** on the handset or telephone base when in idle mode.
2. Press **▼CID** or **▲** to scroll to **Phonebook**, then press **MENU/SELECT**.
3. Press **▼CID** or **▲** to scroll to **Delete all**, then press **MENU/SELECT**.
4. The handset shows **Delete all?**. Press **MENU/SELECT** to confirm. The handset shows **Deleting...**. You hear a confirmation tone.
- OR -
The telephone base shows **Delete all in Phonebook?** Press **MENU/SELECT** to confirm. The screen shows **Deleted**. You hear a confirmation tone.

Redial list

Each handset stores the last 10 dialed numbers (up to 30 digits each) in the redial list. The list of dialed numbers include both dialed home calls and cell calls.

Review a redial list entry

1. Press **REDIAL/PAUSE** in idle mode.
2. Press **▼CID**, **▲** or **REDIAL/PAUSE** repeatedly to browse until the desired number displays. The handset beeps twice at the end of the list.
3. Press **OFF/CANCEL** on the handset or **CANCEL** on the telephone base to exit.

Redial a call from list

- When the desired redial entry displays on the handset, press **HOME/FLASH** or **📞** to dial using the home line, or press **CELL** to dial using the cell line.
- OR -
- When the desired redial entry displays on the telephone base, press **HOME** to dial using the home line, or press **CELL** to dial using the cell line.

- OR -

Using a cordless handset

1. Press **HOME/FLASH** or **📞** to use the home line, or press **CELL** to use the cell line.
2. Press **REDIAL/PAUSE** to enter the redial list.
3. Press **▼CID**, **▲** or **REDIAL/PAUSE** repeatedly to browse until the desired entry displays.
4. Press **MENU/SELECT** to dial the displayed number.

Using the telephone base

1. Press **HOME** to use the home line, or press **CELL** to use the cell line.
2. Press **REDIAL/PAUSE** to enter the redial list.
3. Press **▼CID**, **▲** or **REDIAL/PAUSE** repeatedly to browse until the desired entry displays.
4. Press **MENU/SELECT** to dial the displayed number.

Save a redial entry to the phonebook

1. Press **REDIAL/PAUSE** on the handset or telephone base in idle mode.
2. Press **▼CID**, **▲** or **REDIAL/PAUSE** repeatedly to browse until the desired number displays.
3. Press **MENU/SELECT** twice.
4. The screen displays **Enter number**. Use the dialing keys to edit the number, if necessary.
 - Press **▼CID** or **▲** to move the cursor to the left or right.
 - Press **MUTE/DELETE/VOICE** on the handset or **X/DELETE** on the telephone base to erase a digit.
 - Press and hold **MUTE/DELETE/VOICE** on the handset or **X/DELETE** on the telephone base to erase all digits.
 - Press and hold **REDIAL/PAUSE** to insert a three-second dialing pause (a **P** appears).
5. Press **MENU/SELECT**.
6. The screen displays **Enter name**. Use the dialing keys to enter a name (up to 15 characters). Press a key repeatedly until the desired character shows on the screen.
 - Press **▼CID** or **▲** to move the cursor to the left or right.
 - Press **0** to add a space.
 - Press **MUTE/DELETE/VOICE** on the handset or **X/DELETE** on the telephone base to erase a character.

- Press and hold **MUTE/DELETE/VOICE** on the handset or **X/DELETE** on the telephone base to erase all characters.
7. Press **MENU/SELECT**. You hear a confirmation tone.

Delete a redial list entry

1. Press **REDIAL/PAUSE** to enter the redial list.
2. Press **▼CID**, **▲** or **REDIAL/PAUSE** repeatedly to browse until the desired entry displays.
3. Press **MUTE/DELETE/VOICE** on the handset or **X/DELETE** on the telephone base to delete the displayed number. You hear a confirmation tone.

Chain dialing

Use this feature to initiate a dialing sequence from numbers stored in the phonebook, caller ID log or redial list while you are on a call.

Chain dialing can be useful if you wish to access other numbers (such as bank account numbers or access codes) from the phonebook, caller ID log or redial list.

Access a number from the phonebook while on a call

1. Press **MENU/SELECT**.
2. Press **MENU/SELECT** to select **Phonebook**.
3. Press **▼CID** or **▲** to scroll to the desired entry or perform an alphabetical search, then press **MENU/SELECT** to dial the displayed number.

Access a number from the caller ID log while on a call

1. Press **MENU/SELECT**.
2. Press **▼CID** or **▲** to scroll to **Caller ID log**, then press **MENU/SELECT**.
3. Press **▼CID** or **▲** to scroll to the desired entry, then press **MENU/SELECT** to dial the displayed number.

Access a number from the redial list while on a call

1. Press **REDIAL/PAUSE**.
2. Press **▼CID**, **▲**, or **REDIAL/PAUSE** until the desired number displays.
3. Press **MENU/SELECT** to dial the displayed number.

Caller ID

The telephone stores caller ID information about the last 50 incoming calls in the telephone base.

Memory match

If the incoming telephone number matches the last 7 digits of a telephone number in your phonebook, the name that appears on the screen matches the corresponding name in your phonebook.

For example, if **Christine Smith** calls, her name appears as **Chris** if this is how you entered it into your phonebook.

NOTE

- The number you see on your caller ID is in the format sent by the telephone service provider. It usually delivers 10-digit telephone numbers (area code plus telephone number). If the last 7 digits of the incoming telephone number do not match a number in your phonebook, the name appears as it is delivered by the telephone service provider.

Review the caller ID log

Review the caller ID log to find out who called, to return the call, or to copy the caller's name and number into your phonebook.

1. When the telephone is in idle mode, press **▼CID** to view the caller ID log in reverse chronological order starting with the most recent call.

-OR-

You can also review the caller ID log by pressing **MENU/SELECT** in idle mode, then press **▼CID** or  to scroll to **Caller ID log**. Press **MENU/SELECT** twice to select **Review**.

2. Press **▼CID** or  to scroll through the list. The handset or telephone base beeps twice when you reach the beginning or end of the caller ID log.
3. Press **OFF/CANCEL** on the handset or **CANCEL** on the telephone base to exit the caller ID log.



NOTE

- Only one handset or the telephone base can review the caller ID log at time. If another handset tries to enter the phonebook, caller ID log or call block list, it shows **Not available**.

Save a caller ID log entry to the phonebook

1. While reviewing the caller ID log, press **▼CID** or  on the handset or telephone base to browse through the caller ID log.
2. When the desired entry displays, press **MENU/SELECT**.
3. Press **MENU/SELECT** again to choose **To Phonebook** on the handset.
-OR-

Press **MENU/SELECT** again to choose **Phonebook** on the telephone base.

4. When the screen shows **Enter number**, use the dialing keys to modify the telephone number (up to 30 digits).
 - Press **▼CID** or  to move the cursor to the left or right.
 - Press **MUTE/DELETE/VOICE** on the handset or **X/DELETE** on the telephone base to erase a digit.
 - Press and hold **MUTE/DELETE/VOICE** on the handset or **X/DELETE** on the telephone base to erase all digits.
 - Press and hold **REDIAL/PAUSE** to insert a three-second dialing pause (a **P** appears).
5. Press **MENU/SELECT** to save the number in the display. The screen shows **Enter name**.
6. Use the dialing keys to modify the name (up to 15 characters).
 - Press **▼CID** or  to move the cursor to the left or right.

- Press **0** to add a space.
 - Press **MUTE/DELETE/VOICE** on the handset or **X/DELETE** on the telephone base to erase a character.
 - Press and hold **MUTE/DELETE/VOICE** on the handset or **X/DELETE** on the telephone base to erase all characters.
 - Press **TONEX** to change the next letter to upper or lower case.
7. Press **MENU/SELECT** to save. You hear a confirmation tone.

NOTES

- The screen shows **Number repeated** if the number is already in the phonebook. You cannot save the same number more than once.
- If you try to save a caller ID log entry to the phonebook without a number, the handset sounds an error tone.
- If the telephone number has more than 15 digits, only the last 15 digits appear in the caller ID log. However, the telephone can still save all digits (up to 24 digits) of that telephone number from the caller ID log in the phonebook.
- You might need to change how a caller ID number is saved in the phonebook if the entry does not appear in the correct format. Caller ID numbers might appear with an area code that is not necessary for local calls, or without a **1** that is necessary for long distance calls.

Save a caller ID log entry to call block list

1. Search for the desired caller ID log entry (See [Review the caller ID log](#)).
2. When the desired entry appears, press **MENU/SELECT**.
3. Press **▼CID** or **▲** to highlight **To Block list** on the handset, or **Block list** on the telephone base, and then press **MENU/SELECT**. The screen displays **Enter number**.
4. Use the dialing keys to edit the number, if necessary.
 - Press **▼CID** or **▲** to move the cursor to the left or right.
 - Press **MUTE/DELETE/VOICE** on the handset or **X/DELETE** on the telephone base to erase a digit.
 - Press and hold **MUTE/DELETE/VOICE** on the handset or **X/DELETE** on the telephone base to erase all digits.
 - Press and hold **REDIAL/PAUSE** to insert a three-second dialing pause (a **P** appears).
5. Press **MENU/SELECT**. The handset displays **Enter name**.
6. Use the dialing keys to edit the name.
 - Press **▼CID** or **▲** to move the cursor to the left or right.
 - Press **0** to add a space.
 - Press **MUTE/DELETE/VOICE** on the handset or **X/DELETE** on the

telephone base to erase a character.

- Press and hold **MUTE/DELETE/VOICE** on the handset or **X/DELETE** on the telephone base to erase all characters.
 - Press **TONEX** to change the next letter to upper or lower case.
7. Press **MENU/SELECT** to confirm. You hear a confirmation tone.

Save a caller ID log entry to star name list

1. Search for the desired caller ID log entry (See [Review the caller ID log](#)).
2. When the desired entry appears, press **MENU/SELECT**.
3. Press **▼CID** or **▲** to highlight **To Star name** on the handset, or **Star name list** on the telephone base, and then press **MENU/SELECT**. The screen displays **Star the name?**.
4. Press **MENU/SELECT**. The handset displays **Enter name**.

Dial a caller ID log entry

1. Search for the desired caller ID log entry (see [Review the caller ID log](#)).
 2. When the desired entry displays:
 - Press **HOME/FLASH** or **Ⓜ** on the handset, or press **HOME** on the telephone base to dial with the home line.
- OR-**
- Press **CELL** on the handset or telephone base to dial with the cell line.

Delete caller ID entries

To delete an entry

1. Search for the desired caller ID log entry (see **Review the caller ID log**).
2. When the desired entry is displayed, press **MUTE/DELETE/VOICE** on the handset or **X/DELETE** on the telephone base. You hear a confirmation tone.

To delete all entries

1. Press **MENU/SELECT** on the handset or telephone base in idle mode.
2. Press **▼CID** or **▲** to scroll to **Caller ID log**, and then press **MENU/SELECT**.
3. Press **▼CID** or **▲** to scroll to **Delete all**, and then press **MENU/SELECT**.
- OR -
Press **▼CID** or **▲** to highlight **Del all calls** on the telephone base, then press **MENU/SELECT**.
4. When the screen shows **Delete all?** on the handset or **Delete all calls?** on the telephone base, press **MENU/SELECT** to confirm. There is a confirmation tone and the screen returns to the previous menu.

Missed (new) call indicator

When a cordless handset or the telephone base is in idle mode and has new or missed calls, its screen shows **XX Missed calls**.

All new and missed entries are counted as missed calls. Each time you review a new caller ID log entry (indicated by **NEW** on the screen), the missed calls message goes away. When there is a new unanswered call, the missed calls message displays again. The number of missed calls includes all new and missed entries that have not been reviewed.

If you do not want to review the missed calls one by one, but still want to keep them in the caller ID log, you can press and hold **OFF/CANCEL** on the handset for four seconds when the handset is idle. You will hear a confirmation tone. All the entries in the caller ID log become old (reviewed already), and the missed calls message goes away.

Introducing Bluetooth®

Your new **DS6951/DS6951-2/DS6951-3/DS6951-4/DS6951-5/VS306/VS306-2/VS306-3/VS306-4/VS306-5** telephone system with Bluetooth wireless technology has the following features:

- Pair up to two Bluetooth enabled devices (two cell phones, or one cell phone and one headset) with the telephone base.
- Connect a maximum of two Bluetooth enabled devices to make and receive cell calls. Only one cell phone can be active on a call at a time.
- Connect a Bluetooth enabled headset for making and receiving home calls.
- Make and receive calls using your cell phone service with your telephone base or system handsets.
- Download phonebook entries from your cell phone.

IMPORTANT INFORMATION

- Your **DS6951/DS6951-2/DS6951-3/DS6951-4/DS6951-5/VS306/VS306-2/VS306-3/VS306-4/VS306-5** is compatible with Bluetooth version 2.0 or above devices.
- After plugging in the telephone base, wait at least 20 seconds before connecting a Bluetooth device. The screen shows Bluetooth system busy if you try to connect too soon.

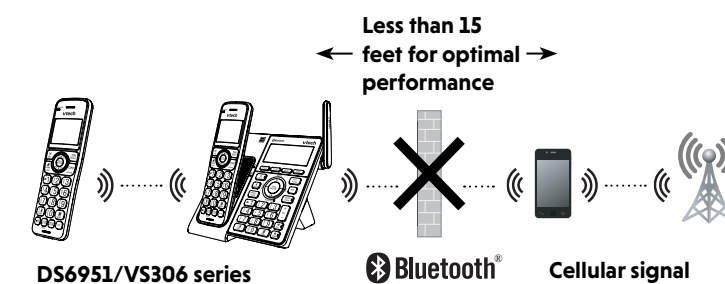

- Refer to the user's manual of your Bluetooth enabled cell phone or headset for more information about how that device uses Bluetooth connectivity.
- Bluetooth wireless technology operates within a short range (a maximum of approximately 15 feet) from the telephone base. Keep connected cell phones and headsets within this range.
- If your cell phone has poor reception in your home, the **DS6951/DS6951-2/DS6951-3/DS6951-4/DS6951-5/VS306/VS306-2/VS306-3/VS306-4/VS306-5** cannot improve the reception. However, if there is a location in your house with better reception, you can leave your cell

phone at that location while you use the **DS6951/DS6951-2/DS6951-3/DS6951-4/DS6951-5/VS306/VS306-2/VS306-3/VS306-4/VS306-5** cell line. For optimal performance, the cell phone must be within 15 feet of the telephone base.

- If you experience poor sound quality, it may be caused by the distance between your cell phone and the telephone base. To improve the performance, place your cell phone closer to the telephone base (within 15 feet) and make sure that there are no physical obstacles such as large furniture or thick wall in between.
- Charge your cell phone while it is connected to the telephone base. Your cell phone's battery discharges faster while it is connected to the telephone base via Bluetooth wireless technology.
- Monitor your cell phone's usage, because minutes may be deducted from your cellular plan for the duration of all cell calls, depending on the terms of your plan.

Refer to the **Bluetooth Setup** section to learn how to set up your Bluetooth device. Refer to the telephone operation on how to operate your Bluetooth devices with your new **DS6951/DS6951-2/DS6951-3/DS6951-4/DS6951-5/VS306/VS306-2/VS306-3/VS306-4/VS306-5** telephone system with Bluetooth wireless technology.

The Bluetooth® word mark and logos are owned by Bluetooth SIG, Inc. and any use of such marks by Advanced American Telephones and its parent, VTech Holdings Limited, is under license. VTech

Holdings Limited is a member of Bluetooth SIG, Inc. Other trademarks and trade names are those of their respective owners.

Refer to the Bluetooth setup section to learn how to set up your Bluetooth device. Refer to the Telephone operation section on how to operate your Bluetooth devices with your new telephone system with Bluetooth wireless technology.



Glossary of terms

Below are some terms used in this user's manual to help you become familiar with using your Bluetooth devices and your new VTech telephone system.





Active device slots - the **Device list** has two active slots for two cell phones, or one cell phone and one headset. In order to use a Bluetooth device on a call, it must be in an active slot and be connected.

Bluetooth cell phone - refers to a mobile Bluetooth enabled cellular telephone.



CELL line - the telephone line associated with your cell phone service. Press  **CELL** on your handset or telephone base to use the cell line.

Connected - when you pair a Bluetooth device to your telephone system, it is placed in an active slot and automatically connected. When a device is connected, a **1** and/or **2** will display after  on the telephone base screen. Also, the  **1** and/or  **2** light on the telephone base will be on. If a device loses its connection to the telephone base, it must be reconnected before you can use the device with the telephone system.

Device list - The list of devices that have been paired to the telephone. You can pair up to 2 Bluetooth enabled devices (cell phones or headsets).

Disconnected - when device(s) is/are disconnected,  ¹ and/or  ₂ is/are not displayed on the handset screen. The  **1** and/or  **2** light on the telephone base is/are off.

Discoverable mode - before a Bluetooth enabled device can be paired, it must be set to this mode. When pairing your cell phone, the telephone base will be set to this mode. Depending on the manufacturer, this mode is sometimes referred to as **Find Me** or **Visibility**.

HOME line - your conventional telephone land line. On your telephone system, press  **HOME/FLASH** on the handset or  **HOME** on the telephone base to use the home line.

Paired devices - The Bluetooth enabled devices (cell phones or headsets) that have shared registration information with the telephone base. A total of two Bluetooth enabled devices can be paired to the telephone base. However, only one paired device can communicate with the base at a time.

Pairing - sometimes referred to as **bonding**. The process of sharing registration information between two Bluetooth enabled devices. Your Bluetooth enabled cell phone or headset must first be paired to the telephone base in order to use it with this telephone system.

VTech Connect to Cell™ application

If you are using Bluetooth-enabled Android® phones (OS 2.3 or higher), you can further extend the flexibility of your telephone system with use of the free **Connect To Cell** application.

VTech **Connect to Cell** comprises **Caller ID manager** and **Alerts manager** that help you integrate your cell phone with your new telephone system.

To learn more or download this application via Google Play® Store, go to https://www.vtechphones.com/app_connect_to_cell.



Bluetooth setup

To use a Bluetooth enabled cell phone with your **DS6951/DS6951-2/DS6951-3/DS6951-4/DS6951-5/VS306/VS306-2/VS306-3/VS306-4/VS306-5**, you must first pair and connect it with the telephone base. The **DS6951/DS6951-2/DS6951-3/DS6951-4/DS6951-5/VS306/VS306-2/VS306-3/VS306-4/VS306-5** telephone base and all system handsets can be used to make or answer calls on the cell phone line.

Bluetooth wireless technology operates within a short range (up to 15 feet). When you pair a Bluetooth cell phone or Bluetooth headset to the telephone base, keep the device within 15 feet of the telephone base for optimal performance.

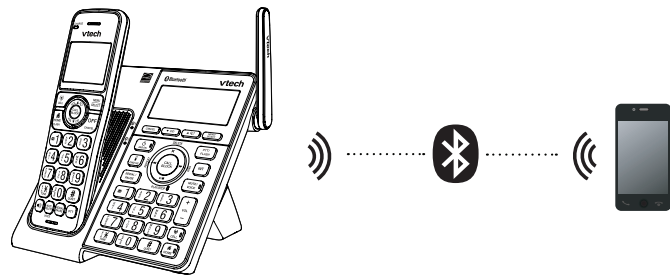

Add a cell phone

Before you begin, make sure that you have cellular coverage and your Bluetooth enabled cell phone is not connected to any other Bluetooth device. Refer to your cell phone user's manual to learn how to search for or add new Bluetooth devices.

To pair and connect a cell phone:

1. Press **MENU/SELECT** on the telephone base in idle mode to enter the main menu.
2. Press **▼CID** or **▲** to highlight **Bluetooth**, then press **MENU/SELECT**.
3. Press **MENU/SELECT** to choose **Add cellular**. The screen displays **Please wait...** followed by **Adding cell...**
 - If there are already 2 paired devices on the list, the telephone prompts you to select a device slot. If you select a slot, the telephone displays **Disconnect Cell Phone X? (Cell Phone Y represents the device name of your cell phone)** If you press **MENU/SELECT** to confirm, the current paired device will be automatically removed, regardless of whether the pairing of the new device is successful or not.
4. Promptly turn on the Bluetooth feature of your cell phone and search for or add new devices.

5. Once your cell phone finds your VTech phone (**VTech DECT 6.0**), press the appropriate key on your cell phone to continue the pairing process.
6. When the cell phone successfully connects to the telephone, the telephone screen displays **Cellular added**, and the corresponding status icon (📶 1 or 📶 2) displays. The corresponding device light on the telephone base (📶 1 or 📶 2) turns on.

NOTES

- The pairing process may take up to one minute. If the pairing process fails, try again.
- The steps for the pairing process may vary for different cell phones. If this happens, follow the prompts on your cell phone and your **DS6951/DS6951-2/DS6951-3/DS6951-4/DS6951-5/VS306/VS306-2/VS306-3/VS306-4/VS306-5** to complete the pairing process.
- Refer to the user's manual of your cell phone on how to search for or add a new Bluetooth device.

Add a headset

Before you begin, make sure that your Bluetooth enabled headset is not connected to any other Bluetooth device. Refer to your headset user's manual to learn how to search for or add new Bluetooth devices.

To pair and connect a headset:

1. Press **MENU/SELECT** on the telephone base in idle mode to enter the main menu.
2. Press **▼CID** or **▲** to highlight **Bluetooth**, then press **MENU/SELECT**.
3. Press **▼CID** or **▲** to highlight **Add headset**, then press **MENU/SELECT**. The screen displays **Please wait...** followed by **Search headset**.
 - If there are already 2 paired devices on the list, the telephone prompts you to select a device slot. If you select a slot, the telephone displays **Disconnect Cell Phone X? (Cell Phone Y)** represents the device name of your cell phone) If you press **MENU/SELECT** to confirm, the current paired device will be automatically removed, regardless of whether the pairing of the new device is successful or not.
 - If there is another headset already active, the screen will show **Disconnect Headset Y? (Headset Y)** represents the device name of your paired headset) If you press

MENU/SELECT to confirm, the current paired headset will be automatically removed, regardless of whether the pairing of the new device is successful or not.

4. Set your headset to discoverable mode (refer to the user's manual of your headset). The screen displays **Adding Headset Y** when the base is connecting to your headset (**Headset Y** represents the device name of your Bluetooth headset).
5. Once your cell phone finds your VTech phone (**VTech DECT 6.0**), press the appropriate key on your cell phone to continue the pairing process.
6. When the headset successfully connects to the telephone, the telephone screen displays **Headset added**, and the corresponding status icon (1 or 2) displays. The corresponding device light on the telephone base (1 or 2) turns on.

NOTES

- The pairing process may take up to one minute. If the pairing process fails, try again.
- When a connected headset is charging, it may disconnect from the telephone base and the light on the telephone base turns off. For some headset models, you may need to turn on the headset and reconnect it to the telephone base again.

Auto connection

When an active device moves within Bluetooth range of the telephone base, or is turned on within range, the telephone base tries to connect to the device. When the device moves out of range, it is disconnected. Your device might make a connect or disconnect sound.

A connected device could also be disconnected by:

- Turning off the Bluetooth device.
- Turning off the Bluetooth feature of the device.
- Disconnecting through the telephone base **Device list**. If you disconnect through the **Device list**, the telephone base will not attempt to reconnect until your device is moved out of range and then moves back in range again.

Device list and connection

Up to 2 devices can be paired to the telephone base. All paired devices are shown on the device list. To use a paired device, it must be connected. Both Bluetooth enabled devices can be used on a cell call at a time.

Once you have paired a device with the telephone base, you do not need to repeat the pairing procedure again unless you delete the device from the device list.

NOTE

- When connecting a Bluetooth device to the device list, all connected devices will be temporarily disconnected until the procedure is complete. It may take up to two minutes to reconnect.

Review the device list

1. Press **MENU/SELECT** on the telephone base in idle mode to enter the main menu.
2. Press **▼CID** or **▲** to highlight **Bluetooth**, then press **MENU/SELECT**.
3. Press **MENU/SELECT** again to select **Device list**.

Connect/disconnect an active device

While in the device list menu, you may connect or disconnect your active device.

1. Press **MENU/SELECT** on the telephone base in idle mode to enter the main menu.
2. Press **▼CID** or **▲** to highlight **Bluetooth**, then press **MENU/SELECT**.
3. Press **▼CID** or **▲** to highlight **Device list**, then press **MENU/SELECT**.
4. Press **▼CID** or **▲** to highlight a device, then press **MENU/SELECT**.
5. Press **▼CID** or **▲** to highlight **Connect/Disconnect** (whichever is applicable), then press **MENU/SELECT**. The telephone base displays **Device connected/Device disconnected**. You hear a confirmation tone.

NOTE

- When your active device is connected, you are prompted to select **Disconnect**. When your active device is disconnected, you are prompted to select **Connect**.

Remove a paired device

When you already have 2 devices on the device list and you want to add another device, you must first delete one from the list. You can only pair 2 cell phones or one cell phone and one Bluetooth headset.

To remove a paired device:

1. Press **MENU/SELECT** on the telephone base in idle mode to enter the main menu.
2. Press **▼CID** or **▲** to highlight **Bluetooth**, then press **MENU/SELECT**.
3. Press **▼CID** or **▲** to highlight **Device list**, then press **MENU/SELECT**.
4. Press **▼CID** or **▲** to highlight the desired device, then press **X/DELETE**.
-OR-
 - Press **▼CID** or **▲** to highlight the desired device, then press **MENU/SELECT**.
 - Press **▼CID** or **▲** to highlight **Remove**, then press **MENU/SELECT**.
5. The telephone base displays **Remove Headset X?** (**Headset X** represents the device name of your Bluetooth headset). Press **MENU/SELECT** to confirm. The telephone base displays **Device removed from device list** and you hear a confirmation tone.

Download phonebook

You can download cell phone phonebook entries to your **DS6951/DS6951-2/DS6951-3/DS6951-4/DS6951-5/VS306/VS306-2/VS306-3/VS306-4/VS306-5** telephone system via Bluetooth wireless technology. Each downloaded cell phone phonebook entry are stored in the telephone phonebook with up to 30 digits for each phone number and 15 characters for each name.

Before downloading a phonebook, make sure the cell phone is paired, active, and connected to your telephone system. Place your cell phone next to the telephone base when you download a cell phone phonebook to your telephone system.

To download a cell phone phonebook:

1. Press **MENU/SELECT** on the telephone base in idle mode to enter the main menu.
2. Press **▼CID** or **▲** to highlight **Bluetooth**, then press **MENU/SELECT**.
3. Press **▼CID** or **▲** to highlight **Download PB**, then press **MENU/SELECT**. The handset displays **Select a device** briefly.
 - If there is no cell phone paired to the system, the handset displays **Pair cell first** and then returns to the previous menu.

4. Press **▼CID** or **▲** to highlight a device, then press **MENU/SELECT**.
 - If the selected device is not available, the handset returns to the previous menu.During the download, the handset flashes **Downloading...** All other idle system handsets display **Downloading...**
5. When the downloading process completes or when the memory is full, the handset displays **Entries added: XXX**. Then the handset returns to the **Bluetooth** menu.

NOTES

- Cell phone contacts can be downloaded from the phone memory only. You can transfer the contacts from your SIM card to your cell phone memory first, and then download from your cell phone memory. For more information on how to transfer contacts from your SIM card to your cell phone memory, see the user's manual of your cell phone.
- When downloading the phonebook from your Bluetooth enabled cell phone, some data may not transfer. For example, if you have home, mobile and work numbers for a particular contact, the three category descriptions may not transfer to your **DS6951/DS6951-2/DS6951-3/DS6951-4/DS6951-5/VS306/VS306-2/VS306-3/VS306-4/VS306-5**.

Remote voice control

If you have connected a cell phone to the **DS6951/DS6951-2/DS6951-3/DS6951-4/DS6951-5/VS306/VS306-2/VS306-3/VS306-4/VS306-5** telephone system, you can activate the voice-controlled application (voice app) of the cell phone, such as Siri®, Google Now™ or S Voice®, using your handset or telephone base. The remote voice control feature works with:

Voice-controlled application	Siri	Google Now	S Voice
Operation System (Versions supported)	iOS (8 or above)	Android (4 or above)	Android (4 or above)

Before using the remote voice control feature, make sure you checked the following:

- Your cell phone is paired and connected to your telephone system via Bluetooth.
- No Bluetooth applications are running in the background of your cell phone.
- Keep your cell phone within 15 feet of the telephone base.
- Do not lock up your cell phone's screen or set passcode for activating the voice app.
- Make sure you have turned on or logged in to the applications on your cell phone that you will be sending your voice commands, such as GPS, e-mail and social networking accounts.
- Your cell phone's data or Wi-Fi signal is in full strength and your cell phone can connect to the Internet.

- Try to activate the voice app on your cell phone to ensure it is in place.

Activate remote voice control

1. Press **MUTE/DELETE/VOICE** on the handset or **MUTE/VOICE** on the telephone base.
 - If you have connected two cell phones to the telephone, the telephone shows **Select a device:**. Press **▼CID** or **▲** to highlight the desired device, then press **MENU/SELECT**.
 - If the activation fails, the telephone displays **Not available**.
2. When the telephone base or handset plays the confirmation tone as forwarded by the cell phone's voice app, start speaking toward the telephone base or handset, and then wait for feedback. Make reply to the voice app's feedback, if necessary.
 - You can press **⏏** on the handset to turn off the speakerphone and listen to the feedback through the handset earpiece.
3. To end the current remote voice control session, press **CANCEL** on the telephone base or handset. You can restart by following Steps 1-2 mentioned above.

NOTES

- Once you have activated the remote voice control feature, you are using your cell phone's voice app to operate your cell phone.

- Please check the cell phone user's manual and the voice app's help topics to find out what commands you can use and any limitations of the voice app.
- Some cell phone manufacturers or network carriers may customize the phone's operating system and implement their own voice app. If you want to use Google Now, you need to manually set it as your default voice app. For detailed instructions, refer to your cell phone user's manual, or contact your cell phone's manufacturer or network carrier. You may also go to "Google Product Forums" on the Internet and check the corresponding help topics.
- Due to the settings of certain cell phones and voice apps, your cell phone may not support the remote voice control feature. Contact your cell phone's manufacturer or network carrier, or check the voice app's help topics if you encounter any problems.
- During the remote voice control activation, if your Android cell phone comes with both a dedicated voice app and Google Now, it may prompt you to select which voice app to use,

and whether use it for just once or always. Select the desired options. If you do not respond to your cell phone's prompt in time, the handset screen will return to idle, and the  icon will disappear. You can restart by following Steps 1-3 mentioned above.

- If you receive a landline or cell line incoming call when you have activated remote voice control on a connected cell phone, the remote voice control operation will be ended.
- The feature may be ended automatically by your cell phone. For example, a cell call has been established via the remote voice control feature and the call has just ended.
- If you need to press dialing keys (**0-9, TONEX** or **QUIET#**) during a cell call, please make the call using the cell lines of your telephone system instead of using the voice app via the remote voice control feature (see **Make, answer or end a cell call** section).

Siri® is a registered trademark of Apple Inc.
 Google Now™ is a trademark of Google Inc.
 S Voice® is a registered mark of Samsung Electronics Co., Ltd.
 IOS is a trademark or registered trademark of Cisco in the U.S. and other countries and is used under license.

About Smart call blocker*

If you have subscribed to caller ID service, then you can use Smart call blocker to screen incoming calls.

Smart call blocker is an effective call screening tool, which allows your phone system to screen **ALL** home calls.

The screening feature of Smart call blocker is applicable to home calls only. All incoming cell calls will get through and ring. If you want to block a cell call, add the number to the block list. Read on and learn how to change to call screening mode†, add the number to the block list, and perform the necessary preparations before use.

† With Call screening active, Smart Call Blocker screens and filters all incoming home calls from numbers or names that are not saved in your Phonebook, Block list, or Star name list. You can easily add incoming phone numbers to your Block list. This allows you to build up your lists of allowed and blocked numbers, and Smart Call Blocker will know how to handle these calls when they call again. This allows you to build up your lists of allowed and blocked numbers, and Smart call blocker will know how to deal with these calls when they come in again.

What is Smart call blocker?

Smart call blocker filters robocalls and unwanted calls for you, while allowing welcome calls to get through.

You can set up your lists of welcome callers and unwelcome callers. The Smart call blocker allows calls from your welcome

callers to get through, and it blocks calls from your unwelcome callers.

For other unknown home calls, you can block, screen, or forward these calls to the answering system.

With some easy configurations, you can set to only filter robocalls on the home line by asking the callers to press the pound key (#) before the calls are put through to you.

You can also set the Smart call blocker to screen home calls by asking the callers to record their names and press the pound key (#). After your caller completes the request, your telephone rings and announces the caller's name. You can then choose to block or answer the call, or you can forward the call to the answering system.

If the caller hangs up, or does not respond or record his/her name, the call is blocked from ringing through.

When you add your welcome callers to your Phonebook, they will bypass all screening and ring directly to your handsets.

NOTES

- To turn on or off Smart call blocker screening, see **No screening**.

Call categories

Calls are classified into four categories:

Welcome calls

Welcome calls are calls with telephone numbers saved in your phonebook, and not in your block list. Welcome calls also include calls with caller names saved in your star name list.

NOTES

- All incoming calls on your cell lines will get through and ring, unless the caller's numbers are saved in your block list. If you want to block a cell call, add the number to the block list. See **Block list**.
- There are many organizations like schools, medical offices, and pharmacies that use robocalls to communicate important information to you. Robocall uses an autodialer to deliver pre-recorded messages. By entering the **EXACT** Caller ID (CID)'s name of the organizations into the star name list, it ensures these calls will ring through when you only know the caller names but not their numbers.

Unwelcome calls

Unwelcome calls are calls with telephone numbers saved in your block list, and you want to block their calls.

Unknown calls

Calls without numbers (for home calls only)

Calls without numbers are calls that are "out of area" or with numbers set to "Private".

Uncategorized calls (for home calls only)

Uncategorized calls include calls with absent caller ID number, calls with numbers that are not in your phonebook or block list, or calls with caller ID names that are not in your star name list.

NOTE

- The block list stores up to 1,000 entries, and the star name list stores up to 10 names.

* Includes licenced Qaltel™ technology. Qaltel™ is a trademark of Truecall Group Limited.

SCB screening

You can set Smart call blocker to handle all unknown home calls with one of the following options.

- **No screening** (default setting) - allow all unknown home calls to get through and ring.
- **Screen unknown** - screen all unknown home calls.
- **UnknownToAns.S** - forward all unknown home calls to the answering system.
- **Block unknown** - block all unknown home calls.

NOTES

- If your phonebook, star name list and block list are empty when **SCB screening** is set to **Screen unknown**, the telephone will screen all incoming home calls and asks callers to announce their names or press the pound key (#).
- If **SCB screening** is set to **No screening** (default setting), all incoming home and cell calls ring, including numbers saved in the block list.
- If **QUIET** mode is on, and **SCB screening** is set to **Screen unknown**, all screened home calls will be sent to the answering system after screening.

No screening (default setting)

If you select **No screening**, the telephone allows all incoming unknown calls to get through and ring.

1. Press **CALL BLOCK** on the handset or telephone base to enter the call block menu when the telephone is not in use.
- OR -
Press **MENU/SELECT** to enter the main menu when the handset is not in use. Then, press **▼CID** or **▲**  to scroll to **SCB screening**. Press **MENU/SELECT**.
2. Press **MENU/SELECT** to select **No screening**.

Screen unknown

You can set Smart call blocker to screen all unknown home calls (**Screen unknown**).

You can set it to screen calls and ask the unknown caller to say his/her name before the call rings on your telephone.

Alternatively, you can set it to screen robocalls only. The telephone will screen calls and ask the caller to press the pound key (#) before putting the calls through to you.

You can choose one of the two types of screening announcement for handling unknown callers and robocalls.

Screen unknown callers (default setting)

If you set Smart call blocker to screen all unknown callers, the telephone asks the caller to say his/her name before putting the call through and rings.

You can then answer the call, and hear the caller's name announced.

You can decide whether to accept or reject the call, or to forward the call to the answering system.

Set SCB screening to screen unknown callers:

1. Press **CALL BLOCK** on the handset or telephone base to enter the call block menu when the telephone is not in use.

- OR -

Press **MENU/SELECT** to enter the main menu when the handset is not in use. Then, press **▼CID** or **▲**  to scroll to **SCB screening**. Press **MENU/SELECT**.

2. Press **▼CID** or **▲**  to scroll to **Screen unknown**, then press **MENU/SELECT**.

Choose screening announcement to screen unknown callers:

1. Press **CALL BLOCK** on the handset or telephone base to enter the call block menu when the telephone is not in use.

- OR -

Press **MENU/SELECT** to enter the main menu when the handset is not in use. Then, press **▼CID** or **▲**  to scroll to **SCB settings**. Press **MENU/SELECT**.

2. Press **▼CID** or **▲**  to scroll to **Screening annnc**, then press **MENU/SELECT**.
3. Press **MENU/SELECT** to select **SCB annnc type**.
4. Press **MENU/SELECT** to select **Unknown caller** (default setting).

Screen robocalls only

If you set Smart call blocker to screen robocalls only, the telephone asks the caller to press the pound key (#) before putting the call through and rings.

If the caller does not respond, the call will be terminated.

This option is suitable for you to filter calls that uses autodialers to deliver pre-recorded messages, for example, robocalls and telemarketing calls.

Set SCB screening to screen robocalls:

1. Press **CALL BLOCK** on the handset or telephone base to enter the call block menu when the telephone is not in use.

- OR -

Press **MENU/SELECT** to enter the main menu when the handset is not in use. Then, press **▼CID** or **▲** to scroll to **SCB screening**. Press **MENU/SELECT**.

2. Press **▼CID** or **▲** to scroll to **Screen unknown**, then press **MENU/SELECT**.

Choose screening announcement to screen robocalls:

1. Press **CALL BLOCK** on the handset or telephone base to enter the call block menu when the telephone is not in use.

- OR -

Press **MENU/SELECT** to enter the main menu when the handset is not in use. Then, press **▼CID** or

▲ to scroll to **SCB settings**. Press **MENU/SELECT**.

2. Press **▼CID** or **▲** to scroll to **Screening annc**, then press **MENU/SELECT**.

3. Press **MENU/SELECT** to select **SCB annc type**.

4. Press **▼CID** or **▲** to scroll to **Robocalls only**, then press **MENU/SELECT**.

Forward all unknown calls to answering system

If you select **UnknownToAns.S**, the telephone forwards all incoming unknown calls to the answering system without ringing.

1. Press **CALL BLOCK** on the handset or telephone base to enter the call block menu when the telephone is not in use.

- OR -

Press **MENU/SELECT** to enter the main menu when the handset is not in use. Then, press **▼CID** or **▲** to scroll to **SCB screening**. Press **MENU/SELECT**.

2. Press **▼CID** or **▲** to scroll to **UnknownToAns.S**, then press **MENU/SELECT**.

Block unknown calls

If you select **Block unknown**, the telephone rejects all unknown home calls with block announcement without ringing. The caller's number, even if it's available, will not be saved to the block list.

1. Press **CALL BLOCK** on the handset or telephone base to enter the call block menu when the telephone is not in use.

- OR -

Press **MENU/SELECT** to enter the main menu when the handset is not in use. Then, press **▼CID** or **▲** to scroll to **SCB screening**. Press **MENU/SELECT**.

2. Press **▼CID** or **▲** to scroll to **Block unknown**, then press **MENU/SELECT**.

NOTES

- **No screening** is the default setting. All unknown home calls will ring. If you want to save a caller's number to your block list, you can retrieve the number from caller ID log and save it to the block list. See **Save a caller ID log entry to block list**. If you want to retrieve the name from caller ID log and save it to the star name list. See **Save a caller ID log entry to star name list**.
- When screening a home call, the telephone announces to the caller, "*Hello. Calls to this number are being screened by Smart call*

blocker. Please say your name after the tone, then press pound." After the caller completes the request, the telephone announces to the caller "*Please wait a moment while your call is connected.*". The telephone starts ringing and the handset screen displays **Screened call**. After you pick up the call, the telephone announces the caller's name, and then asks whether you want to answer or reject the call, or to forward the call to the answering system.

- If the caller hangs up before the home call is screened, or without leaving his/her name while the call is being screened, the call will be logged as missed call in the caller ID log.
- While a home call is being screened, you can press **HOME/FLASH** or **END CALL** to stop screening and answer the call.
- After the telephone screened a home call, and is ringing and announcing the caller's name, you can press **OFF/CANCEL** to mute the ringer, or press **CALL BLOCK** to reject the call directly.
- After you picked up a screened home call and the telephone is announcing the screening options, you can press **OFF/CANCEL** to hang up the call.
- If Smart call blocker is on and you receive a call waiting home call:
 - Smart call blocker will not screen a call waiting home call without

number while on a call. You can press **HOME/FLASH** or **END CALL** to take the new call.

- After you have picked up a screened home call, the telephone checks whether the call waiting number is in the phonebook or block list. It also checks whether the caller name is in the star name list. After that, the telephone then displays the caller ID information or "Blocked call" accordingly. You can press **HOME/FLASH** or **END CALL** to take the new call, or press **CALL BLOCK** on the handset or telephone base to block it.
- While the telephone is screening a home call, the new call will be ignored and logged as missed call in the caller ID log.
- Robocalls are unable to respond to the screening announcement, and therefore, will not get through and ring. If you want to allow some robocalls to get through, save their names in the star name list. See **Star name list**.
- The telephone can respond to remote access code while it is playing the screening announcement. This allows you to access your answering system from an unknown number remotely. See **Answering system remote access**.

Block list

Add numbers that you want to prevent their calls from ringing through. The block list stores up to 1,000 entries.

NOTE

- Home or cell calls with numbers that have been added to your block list will be blocked.

Add a block list entry

1. Press **CALL BLOCK** on the handset or telephone base to enter the call block menu when the telephone is not in use.
- OR -
Press **MENU/SELECT** to enter the main menu when the handset is not in use. Then, press **▼CID** or **▲BOOK** to scroll to **Block list**. Press **MENU/SELECT**.
2. Press **▼CID** or **▲BOOK** to scroll to **Add new entry**, then press **MENU/SELECT**.
3. When the screen shows **Enter number**, use the dialing keys to enter a telephone number (up to 30 digits).
 - Press **▼CID** or **▲BOOK** to move the cursor to the left or right.
 - Press **MUTE/DELETE/VOICE** on the handset or **X/DELETE** on the telephone base to erase a digit.
 - Press and hold **MUTE/DELETE/VOICE** on the handset or **X/DELETE** on the telephone base to erase all digits.

- Press and hold **REDIAL/PAUSE** to insert a three-second dialing pause (a **P** appears).

-OR-

Press **REDIAL/PAUSE** to copy a number from the redial list. Press **▼CID** or **▲BOOK**, or press **REDIAL/PAUSE** repeatedly to locate the desired number. Press **MENU/SELECT** to copy the displayed number.

4. Press **MENU/SELECT** to move on to the name.
5. When the screen displays **Enter name**, use the dialing keys to enter a name (up to 15 characters). Press a key repeatedly until the desired character shows on the screen. The first character of every word is capitalized.
 - Press **▼CID** or **▲BOOK** to move the cursor to the left or right.
 - Press **0** to add a space.
 - Press **MUTE/DELETE/VOICE** on the handset or **X/DELETE** on the telephone base to erase a character.
 - Press and hold **MUTE/DELETE/VOICE** on the handset or **X/DELETE** on the telephone base to erase all characters.
 - Press **TONEX** to change the next letter to upper or lower case.
6. Press **MENU/SELECT** to store your new block entry.

Review block list

1. Press **CALL BLOCK** on the handset or telephone base to enter the call block menu when the telephone is not in use.
- OR -
Press **MENU/SELECT** to enter the main menu when the handset is not in use. Then, press **▼CID** or **▲BOOK** to scroll to **Block list**. Press **MENU/SELECT**.
2. Press **MENU/SELECT** to choose **Review**.
3. Press **▼CID** or **▲BOOK** to browse through the block entries.

Save a caller ID log entry to block list

1. Search for the desired caller ID log entry (See [Review the caller ID log](#)).
2. When the desired entry appears, press **MENU/SELECT**.
3. Press **▼CID** or **▲** to highlight **To Block list** on the handset, or **Block list** on the telephone base, and then press **MENU/SELECT**. The screen displays **Enter number**.
4. Use the dialing keys to edit the number, if necessary.
 - Press **▼CID** or **▲** to move the cursor to the left or right.
 - Press **MUTE/DELETE/VOICE** on the handset or **X/DELETE** on the telephone base to erase a digit.
 - Press and hold **MUTE/DELETE/VOICE** on the handset or **X/DELETE** on the telephone base to erase all digits.
 - Press and hold **REDIAL/PAUSE** to insert a three-second dialing pause (a **P** appears).
5. Press **MENU/SELECT**. The handset displays **Enter name**.
6. Use the dialing keys to edit the name.
 - Press **▼CID** or **▲** to move the cursor to the left or right.
 - Press **0** to add a space.
 - Press **MUTE/DELETE/VOICE** on the handset or **X/DELETE** on the telephone base to erase a character.
 - Press and hold **MUTE/DELETE/VOICE** on the handset or **X/DELETE** on the

telephone base to erase all characters.

- Press **TONEX** to change the next letter to upper or lower case.
7. Press **MENU/SELECT** to confirm. You hear a confirmation tone.

Edit a block list entry

1. Search for the desired entry in the block list (see [Review block list](#)).
2. When the desired entry displays, press **MENU/SELECT**. The screen displays **Enter number** along with the phone number to be edited. If you only want to edit the name, skip to Step 4.
3. To edit the number:
 - Use the dialing keys to enter digits.
 - Press **▼CID** or **▲** to move the cursor to the left or right.
 - Press **MUTE/DELETE/VOICE** on the handset or **X/DELETE** on the telephone base to erase a digit.
 - Press and hold **MUTE/DELETE/VOICE** on the handset or **X/DELETE** on the telephone base to erase all digits.
 - Press and hold **REDIAL/PAUSE** to insert a three-second dialing pause (a **P** appears).
4. Press **MENU/SELECT** to move on to the name. The screen shows **Enter name** along with the name to be edited.
5. To edit the name:
 - Use the dialing keys to enter characters.
 - Press **▼CID** or **▲** to move the

cursor to the left or right.

- Press **0** to add a space.
 - Press **MUTE/DELETE/VOICE** on the handset or **X/DELETE** on the telephone base to erase a character.
 - Press and hold **MUTE/DELETE/VOICE** on the handset or **X/DELETE** on the telephone base to erase all characters.
 - Press **TONEX** to change the next letter to upper or lower case.
6. Press **MENU/SELECT** to save the entry.

Unblock a telephone number

1. Search for the desired entry in the block list (see [Review block list](#)).
2. When the desired entry displays, press **MUTE/DELETE/VOICE** on the handset or **X/DELETE** on the telephone base. The screen shows **Delete entry?**.
3. Press **MENU/SELECT** to confirm. The screen show **Deleting...** and then you hear a confirmation tone. Once deleted, you cannot retrieve that entry.

Delete all block list entries

1. Press **CALL BLOCK** on the handset or telephone base to enter the call block menu when the telephone is not in use.
 - OR -
 - Press **MENU/SELECT** to enter the main menu when the handset is not in use. Then, press **▼CID** or **▲** to scroll to **Block list**. Press **MENU/SELECT**.
2. Press **▼CID** or **▲** to highlight **Delete all**, then press **MENU/SELECT**. The handset shows **Delete all?**.
 - OR -
 - Press **▼CID** or **▲** to highlight **Delete all**, then press **MENU/SELECT**. The telephone base shows **Delete all in block list?**.
3. Press **MENU/SELECT** again to confirm. The handset displays **Deleting...**, or the telephone base displays **Deleted**. There is a confirmation tone.

Star name list

There are many organizations like schools, medical offices, and pharmacies that use robocalls to communicate important information to you. Robocall uses an autodialer to deliver pre-recorded messages. By entering the **EXACT** Caller ID (CID)'s name of the organizations into the star name list, it ensures these calls will ring through when you only know the caller names but not their numbers.

If the first 15 characters of the incoming caller ID's name match a name saved in your star name list, the call will get through and ring. The star name list stores up to 10 names.

Add a star name entry

1. Press **CALL BLOCK** on the handset or telephone base to enter the call block menu when the telephone is not in use.
- OR -
Press **MENU/SELECT** to enter the main menu when the handset is not in use. Then, press **▼CID** or **▲** to scroll to **SCB settings**. Press **MENU/SELECT**.
2. Press **MENU/SELECT** to select **Star name list**.
3. Press **▼CID** or **▲** to scroll to **Add new entry**, then press **MENU/SELECT**.
4. When the screen displays **Enter name**, use the dialing keys to enter a name (up to 15 characters). Press a key repeatedly until the desired character

appears. The first character of every word is capitalized.

- Press **▼CID** or **▲** to move the cursor to the left or right.
 - Press **0** to add a space.
 - Press **MUTE/DELETE/VOICE** on the handset or **X/DELETE** on the telephone base to erase a character.
 - Press and hold **MUTE/DELETE/VOICE** on the handset or **X/DELETE** on the telephone base to erase all characters.
 - Press **TONEX** to change the next letter to upper or lower case.
5. Press **MENU/SELECT** to store your star name entry. The display shows **Name repeated** if the name is already in the star name list. You cannot save the same name twice.

Review star name list

1. Press **CALL BLOCK** on the handset or telephone base to enter the call block menu when the telephone is not in use.
- OR -
Press **MENU/SELECT** to enter the main menu when the handset is not in use. Then, press **▼CID** or **▲** to scroll to **SCB settings**. Press **MENU/SELECT**.
2. Press **MENU/SELECT** to select **Star name list**.
3. Press **MENU/SELECT** again to choose **Review**.
4. Press **▼CID** or **▲** to browse through the star name entries.

Save a caller ID log entry to star name list

1. Search for the desired caller ID log entry (See **Review the caller ID log**).
2. When the desired entry appears, press **MENU/SELECT**.
3. Press **▼CID** or **▲** to highlight **To Star name** on the handset, or **Star name list** on the telephone base, and then press **MENU/SELECT**.
4. The handset displays **Star this name?**
5. Press **MENU/SELECT** to confirm. You hear a confirmation tone.

Edit a star name entry

1. Search for the desired entry in the star name list (see **Review star name list**).
2. When the desired entry displays, press **MENU/SELECT**. The screen shows **Enter name** along with the name to be edited.
3. To edit the name:
 - Use the dialing keys to enter characters.
 - Press **▼CID** or **▲** to move the cursor to the left or right.
 - Press **0** to add a space.
 - Press **MUTE/DELETE/VOICE** on the handset or **X/DELETE** on the telephone base to erase a character.

- Press and hold **MUTE/DELETE/VOICE** on the handset or **X/DELETE** on the telephone base to erase all characters.
 - Press **TONEX** to change the next letter to upper or lower case.
4. Press **MENU/SELECT** to save the entry.

Delete a star name entry

1. Search for the desired entry in the star name list (see **Review star name list**).
2. When the desired entry displays, press **MUTE/DELETE/VOICE** on the handset or **X/DELETE** on the telephone base. The screen shows **Delete entry?**.
3. Press **MENU/SELECT** to confirm. The screen show **Deleting...** and then you hear a confirmation tone. Once deleted, you cannot retrieve that entry.

Delete all star name entries

1. Press **CALL BLOCK** on the handset or telephone base to enter the call block menu when the telephone is not in use.
 - OR -
 Press **MENU/SELECT** to enter the main menu when the handset is not in use. Then, press **▼CID** or **▲** to scroll to **SCB settings**. Press **MENU/SELECT**.
2. Press **MENU/SELECT** to select **Star name list**.
3. Press **▼CID** or **▲** to highlight **Delete all**, then press **MENU/SELECT**. The handset shows **Delete all?**.
 - OR -
 Press **▼CID** or **▲** to highlight **Delete all**, then press **MENU/SELECT**. The telephone base shows **Delete all in star name list?**.
4. Press **MENU/SELECT** again to confirm. The handset displays **Deleting...**, or the telephone base displays **Deleted**. There is a confirmation tone.

Screening announcements

If you have set **SCB screening** to screen all unknown callers (**Screen unknown**) or screen robocalls (**Robocalls only**), the callers of the following incoming call categories will hear a screening announcement.

- Home calls that are "out of area" or with numbers set to "Private".
- Home calls with numbers that are not on your phonebook or block list, or with absent caller ID number.
- Home calls with caller ID names that are not on your star name list.

There are two types of screening announcements for screening unknown callers and screening robocalls on home line.

Screening unknown callers (default setting) - *"Hello. Calls to this number are being screened by Smart call blocker. Please say your name after the tone, then press pound."*

- This screening announcement is played if you have set **SCB screening** to **Screen unknown** and set **Screening annc** to **Unknown caller**.

-OR-

Screening robocalls only - *"Hello. Calls to this number are being screened by Smart call blocker. If you're a family member, friend or invited caller, please press pound to be connected. If you're a solicitor, please hang up now."*

- This screening announcement is played if you have set **SCB screening**

to **Screen unknown** and set **Screening annc** to **Robocalls only**.

You can use these announcements, or record your own name to replace "this number" in the announcements.

Record your name for screening announcements

1. Press **CALL BLOCK** on the handset or telephone base to enter the call block menu when the telephone is not in use.

- OR -

Press **MENU/SELECT** to enter the main menu when the handset is not in use. Then, press **▼CID** or **▲** to scroll to **SCB settings**. Press **MENU/SELECT**.

2. Press **▼CID** or **▲** to scroll to **Screening annc**, then press **MENU/SELECT**.
3. Press **▼CID** or **▲** to scroll to **Rec your name**, then press **MENU/SELECT**. The system announces, *"Record after the tone. Press 5 when you are done."*
4. Speak towards the handset to record your name. Press **5** to end recording.

Reset screening announcements

1. Press **CALL BLOCK** on the handset or telephone base to enter the call block menu when the telephone is not in use.
- OR -
Press **MENU/SELECT** to enter the main menu when the handset is not in use. Then, press **▼CID** or **▲** to scroll to **SCB settings**. Press **MENU/SELECT**.
2. Press **▼CID** or **▲** to scroll to **Screening annnc**, then press **MENU/SELECT**.
3. Press **▼CID** or **▲** to scroll to **Reset SCB annnc**, then press **MENU/SELECT**. The screen shows **Reset annnc?**. Press **MENU/SELECT** again to confirm. The screen shows **Annnc reset.** before returning to the previous menu.

Your name will be deleted from all the screening announcements, and the telephone will use the default screening announcements.

Voice guide to set Smart call blocker

This feature is an easy and alternative way for you to do the basic setup of Smart call blocker. You can follow the voice guide to set your telephone system to allow or to screen all incoming home calls, or to screen home calls that do not display a phone number.

1. Press **CALL BLOCK** on the handset or telephone base to enter the call block menu when the telephone is not in use.
- OR -
Press **MENU/SELECT** to enter the main menu when the handset is not in use. Then, press **▼CID** or **▲** to scroll to **SCB settings**. Press **MENU/SELECT**.
2. Press **▼CID** or **▲** to scroll to **Voice guide**, then press **MENU/SELECT**.
3. You hear a voice prompt "*Hello! This voice guide will assist you with the basic setup of Smart call blocker..*"
4. Set up your Smart call blocker feature by inputting the designated numbers, as instructed in the voice guide.
 - Press **1** if you want to screen home calls with telephone numbers that are not saved in your phonebook or star name list; or
 - Press **2** if you do not want to screen calls, and want to allow all incoming calls to get through.

NOTES

- The screening feature of Smart call blocker is applicable to home calls only. All incoming cell calls will get through and ring. If you want to block a cell call, add the number to the block list. See **Block list**.
- You can press **CANCEL** on the telephone base to quit the voice guide at any time.
- After a power outage, the telephone base prompts you to set the date and time. After the date and time setting is done or skipped, the telephone base will prompt if you want to set up Smart call blocker via voice guide. Press **MENU/SELECT** to start the setup.

Screened call options

After the telephone screens a home call and starts ringing, the handset screen displays **Screened call**. Press **HOME/FLASH** or **📞** to pick up the call.

After you picked up the call, the telephone announces "*Call from...*" and the caller's name, and then announces, "*To answer the call, press 1. To answer and save this number to phonebook, press 2. To block this number, press 3. To send this call to the answering system, press 4. To repeat these options, press *.*"

Allow this call once:

- Press **1** to answer the call. The telephone number is only connected for once. If the same number calls again, the telephone will go through the screening process.

Always allow this call:

- Press **2** to answer the call. The telephone number will be added to your phonebook.

Block this call:

- Press **3** or **CALL BLOCK** to block the call. The telephone plays the block announcement "*The number you are calling is not accepting your call. Please hang up.*" to the caller. The telephone number will be added to your block list.

Send this call to the answering system:

- Press **4** to forward the call to the answering system.

End this call:

- If you do not want to take the call, press **OFF/CANCEL** to end the call.

NOTES

- For home calls that are "out of area", "Private", or without caller ID, only options **1** and **4** will be available. The telephone announces *"To answer the call, press 1. To send this call to the answering system, press 4. To repeat these options, press *"*.
- If you select option **4** to send the call to the answering system, the caller can leave a message even if the answering system is off.
- When the telephone is ringing, you can press **MUTE/DELETE/VOICE** on the handset to mute the ringer temporarily.

Option while on a call

When you are on a home or cell call and speaking to the caller, and you do not want to continue the call, you can press **CALL BLOCK** to end the call. The telephone plays the block announcement *"The number you are calling is not accepting your call. Please hang up."* to the caller, and the call will be terminated. The caller's number, if available, will be added to your block list.

- Press **CALL BLOCK** on the handset or telephone base. The screen displays **Block and end?** and the caller's number, if available. Press **MENU/SELECT** to end the call.

NOTE

- You can press **CALL BLOCK** to end the call even if Smart call blocker is turned off.

Retrieve voicemail

When you received a voicemail, the handset and the telephone base display **New voicemail** and .

To retrieve, you typically dial an access number provided by your telephone service provider, and then enter a security code. Contact your telephone service provider for instructions on how to configure the voicemail settings and listen to messages.

NOTE



- After you have listened to all new voicemail messages, the indicators on the screen turn off automatically.

Answering system

Difference between the built-in answering system and voicemail service

Your telephone has separate indicators for two different types of voice messages: those recorded on its built-in digital answering system and those recorded in your telephone service provider's voicemail (fees may apply). Your telephone's built-in digital answering system messages and voicemail messages are separate.

The main differences between them are:

Category	Built-in answering system	Voicemail from telephone service
Storage	Messages are stored in the telephone base.	Messages are stored in a server or system provided by your telephone service.
	Your messages will not be deleted automatically. You have to delete your messages manually.	Your messages may be automatically deleted after a period of time. Contact your telephone service provider for more details.
Method to retrieve messages	When you received new messages, screen displays XX new messages.	When you received new messages, the screen displays  and New voicemail.
	To retrieve messages, usually there are two ways: <ul style="list-style-type: none"> • Press  on the telephone base; or • Access remotely with an access code. 	

Use your built-in answering system

New message indication









The handset and the telephone base screen display **XX new messages**, and the  **PLAY/STOP** light on the telephone base flashes when there are new answering system messages.

If the message alert tone is turned on, the telephone base beeps every 10 seconds when there are message that have not been reviewed. See **Turn on or off the message alert tone.**

Turn on or off the answering system

If you turn the answering system on, it answers calls and records messages only on the home line. If your paired cell phone has voicemail, callers can leave messages with that voicemail service.

Using a cordless handset:



1. Press **MENU/SELECT** in idle mode.
2. Press  **CID** or   to scroll to **Answering sys**, then press **MENU/SELECT**.
3. Press  **CID** or   to scroll to **Answer on/off**, then press **MENU/SELECT**.
4. Press  **CID** or   to highlight **On** or **Off**, then press **MENU/SELECT** to save.

Using the telephone base:

- Press  **ANS ON** to turn the answering system on or off. When the answering system is turned on, it announces, "*Calls will be answered.*" When the answering system is turned off, it announces, "*Calls will not be answered.*"

Playback messages

To listen to messages at the telephone base:

1. Press  **PLAY/STOP** on the telephone base to listen to the messages. If you have new messages, the telephone plays only the new messages (oldest first). If there are no new messages, the telephone plays back all messages (oldest first).
2. The system announces the number of messages, then begins playback. The message sequence is shown on the message window.
3. Press  **PLAY/STOP** to stop the playback.

NOTE

- If there are no messages in the answering system, the system announces, "*You have no message.*" when you attempt to listen to messages.

To listen to messages at the handset:

1. Press **MENU/SELECT** when the handset is idle.
2. Press **MENU/SELECT** again to select **Play messages**. If you have either new or old messages, the messages play automatically.
3. The system announces the number of messages, then begins playback. The message sequence is shown on the handset's screen.
4. Press **OFF/CANCEL** to stop the playback.

Options during playback

When messages are playing on the telephone base:

- Press **VOL +** or **VOL -** to adjust the message playback volume.
- Press **▶/SKIP** to skip to the next message.
- Press **◀/REPEAT** to repeat the message currently playing. Press **◀/REPEAT** twice to listen to the previous message.
- Press **X/DELETE** to delete the current message. The system advances to the next message.
- Press **▶/■/PLAY/STOP** to stop the playback.

When messages are playing on a handset:

- Press **📞** to play the messages through the handset earpiece. Press **📞** again to return to playing messages through the speakerphone.
- Press **VOL ▼** or **VOL ▲** to adjust the message playback volume.
- Press **6** to skip to the next message.
- Press **4** to repeat the message currently playing. Press **4** twice to listen to the previous message.
- Press **3** or **MUTE/DELETE/VOICE** to delete the current message.
- Press **OFF/CANCEL** to stop the playback.

NOTES

- Only one handset or the telephone base can access the answering system at a time.
- During message playback, if there is an incoming call or another handset makes a call, message playback will be stopped.

Screen a call

To screen calls at the telephone base:

If the answering system and call screening are on, the announcement and the incoming message broadcast at the telephone base when a call is answered by the answering system.

Options while a message is being recorded:

- Press **VOL+** or **VOL-** on the telephone base to adjust the call screening volume.
- Press **VOL +** or **VOL -** to temporarily turn on or off the call screening.
- Press **▶/■/PLAY/STOP** to temporarily turn on the call screening if the call screening is set to off.

To screen calls at the cordless handset:

If the answering system is on and a call is being answered by the answering system, the handset shows **To screen call press [SELECT]** at the same time. Press **MENU/SELECT** to screen the call on your handset. The handset shows the caller's information. If you do not subscribe to caller ID service, the handset shows **Screening...**

Options while a message is being recorded:

- Press **VOL ▼** or **VOL ▲** on the handset to adjust the call screening volume.
- Press **📞** to switch between speakerphone mode and handset mode.

- Press **🏠 HOME/FLASH** to answer the call.

Call intercept while using answering system

If you want to talk to the caller whose message is being recorded, press **🏠 HOME/FLASH** or **📞** on the handset.

Delete all messages

Using the telephone base:

1. Press **X/DELETE** in idle mode. The telephone announces, *"To delete all old messages, press DELETE again."*
2. Press **X/DELETE** again. All previously reviewed messages are erased and the telephone announces, *"All old messages deleted."*

Using a cordless handset:

1. Press **MENU/SELECT** in idle mode.
2. Press **▼CID** or **▲** to highlight **Answering sys**, then press **MENU/SELECT**.
3. Press **▼CID** or **▲** to highlight **Delete all old**, then press **MENU/SELECT**.
4. Press **MENU/SELECT** to confirm. The handset displays **Deleting...**, then **No old messages** and then returns to the previous menu. You hear a confirmation tone.

Record a memo

Memos are your own recorded messages used as reminders for yourself or others using the same answering system. You can record your own memos using a system handset or the telephone base. Play and delete them the same way as incoming messages.

1. Press **MENU/SELECT** on the handset or telephone base in idle mode.
2. Press **▼CID** or **▲** to highlight **Answering sys**, then press **MENU/SELECT**.
3. Press **▼CID** or **▲** to highlight **Record memo**, then press **MENU/SELECT**. The system announces, *"Record after the tone. Press 5 when you are done."* Speak towards the handset microphone.
4. Press **5** to stop recording. The system announces, *"Recorded."* and then returns to the previous menu. The system does not save memos shorter than two seconds.

NOTES

- Each message can be up to 3 minutes in length.
- Play and delete them in the same way as incoming messages.
- The system will announce *"Memory is full"* if you record a memo when the memory is full.
- Memos shorter than two seconds are not recorded.

Answering system remote access

A two-digit security code is required to access the answering system remotely from any touch-tone telephone. The preset code is **19**. You can use this preset code, or set your own.

1. Dial your telephone number from any touch-tone telephone.
2. When the system plays your announcement, enter the two-digit security code.
3. Enter one of the following remote commands.

Command	Description
1	Play all messages.
2	Play new messages.
3	Delete the current messages (during playback).
33	Delete all old messages.
4	Repeat the current message (during playback).
5	Stop
*5	Hear a list of remote commands.
6	Skip to the next message (during playback).
*7	Record a new announcement.
8	End the call.
0	Turn the answering system on or off.

4. Hang up or press **8** to end the call.

NOTES

- If you do not press any keys after you enter the remote access code, all new messages play. If there are no new messages, all old messages play.
- Once the new messages have played, the telephone announces the help menu options. If you do not press any key within 20 seconds, the remote access call automatically disconnects.
- When the answering system memory is full, the telephone announces, *"Memory is full. Enter the remote access code."*
- When the answering system is off, the telephone answers after 10 rings, and announces, *"Please enter your remote access code."*

Announcement

Default announcement

The telephone is preset with a greeting that answers calls with *"Hello, please leave a message after the tone."* You can use this preset announcement, or replace it with your own.

Record your own announcement

The announcement can be up to 90 seconds in length.

1. Press **MENU/SELECT** when the phone is not in use.
2. Press **▼CID** or **▲**  to scroll to **Answering sys**, and then press **MENU/SELECT** to select.
3. Press **MENU/SELECT** again to choose **Announcement**.
4. The screen displays **Play [2] Del [3] Rec [7]** and it announces, *"To play, press 2. To record, press 7."* Press **7** to record. The phone announces, *"Record after the tone. Press 5 when you are done."* **-OR-** Press **MENU/SELECT** to select **Record annc** using the telephone base. The system announces, *"Record after the tone. Press 5 when you are done."*
5. After the tone, speak towards the microphone. Press **5** when you are done.

Play your announcement

1. Press **MENU/SELECT** when the phone is not in use.
2. Press **▼CID** or **▲**  to scroll to **Answering sys**, and then press **MENU/SELECT** to select.
3. Press **MENU/SELECT** again to choose **Announcement**.
4. The screen displays **Play [2] Del [3] Rec [7]** and it announces, *"To play, press 2. To record, press 7."* Press **2** to play the current announcement.

To listen to the recorded announcement again on the telephone base, scroll to **Play annc** and press **MENU/SELECT**.

Options during playback

- Press **VOL ▼** or **VOL ▲** on the cordless handset, or **VOL -** or **VOL +** on the telephone base to adjust the listening volume.
- Press **5** or **OFF/CANCEL** on the handset or press **CANCEL** on the telephone base to stop at any time.
- Press **🔊** to switch between the speakerphone and handset earpiece.

Delete your announcement

Using the handset:

1. Press **MENU/SELECT** when the phone is not in use.
2. Press **▼CID** or **▲**  to scroll to **Answering sys**, and then press **MENU/SELECT** to select.
3. Press **MENU/SELECT** again to choose **Announcement**.
4. The screen displays **Play [2] Del [3] Rec [7]** and it announces, *"To play, press 2. To record, press 7."* Press **3** to delete your recorded announcement.
 - The screen displays **Annc deleted**.
 - You hear a confirmation tone.

NOTE

- After you deleted your own recorded announcement, the answering system answers calls with the default announcement.

Using the telephone base:

1. Press **MENU/SELECT** when the phone is not in use.
2. Press **MENU/SELECT** again to select **Answering sys**.
3. Press **MENU/SELECT** again to choose **Announcement**.
4. Press **▼CID** or **▲**  to scroll to **Reset annc**, then press **MENU/SELECT**. The screen shows **Reset to default annc?**
5. Press **MENU/SELECT** again. The screen shows **Annc. reset to default**.

When your announcement is reset, the system answers calls with the default announcement, as described above. You cannot delete the default announcement.

Configure | Settings

Set languages

The LCD language is preset to English. You can select English, French or Spanish to be used in all screen displays.

1. Press **MENU/SELECT** in idle mode.
2. Press **▼CID** or **▲** to highlight **Settings**, then press **MENU/SELECT**.
3. Press **MENU/SELECT** to select **LCD language**.
4. Press **▼CID** or **▲** to choose **English**, **Français** or **Español**, and then press **MENU/SELECT**.

NOTE

- If you accidentally change the LCD language to French or Spanish, you can reset it to English easily by pressing **MENU/SELECT** then entering:-

*** 364 #**
TO NE QUI ET

Set voice language

The voice prompt language is preset to English. You can select English or French to be used for the voice prompts in your answering system.

1. Press **MENU/SELECT** in idle mode.
2. Press **▼CID** or **▲** to highlight **Settings**, then press **MENU/SELECT**.
3. Press **▼CID** or **▲** to highlight **Voice language**, then press **MENU/SELECT**.
4. Press **▼CID** or **▲** to choose **English** or **Français**, and then press **MENU/SELECT**.

Set date and time

NOTE

- Make sure you set the date and time including the year correctly; otherwise the answering system does not announce the correct day of the week for your recorded messages time stamp.
1. Press **MENU/SELECT** when the phone is not in use.
 2. Press **▼CID** or **▲** to choose **Set date/time**, and then press **MENU/SELECT** to select.
 3. Use the dialing keys (**0-9**) to enter the month (**MM**), date (**DD**) and year (**YY**). Then, press **MENU/SELECT** to move on to set the time.
 4. Use the dialing keys (**0-9**) to enter the hour (**HH**) and minute (**MM**). Then, press **▼CID** or **▲** to choose **AM** or **PM**.
 5. Press **MENU/SELECT** to save.

Caller ID announce

The caller ID announce feature lets you know who's calling without having to look at the display. When you have an incoming call, the handset and/or base speaks "*Call from...*" and the name of the caller based on the phonebook or caller ID information. If the caller's name is private or unknown, the phone number up to the last 11 digits will be announced. If the caller's phone number is also private or unknown, no information will be announced.

To turn on or off the caller ID announce feature:

1. Press **MENU/SELECT** when the phone is not in use.
2. Press **▼CID** or **▲** to scroll to **Caller ID annnc**, and then press **MENU/SELECT** to select.
3. Press **▼CID** or **▲** to highlight **On** or **Off**, and then press **MENU/SELECT**.

NOTES

- To use the caller ID announce feature, you must subscribe to caller ID service from your telephone service provider.
- This feature does not announce information for call waiting calls.



- It takes at least two rings for the phone to receive caller ID information and announce it. If the phone is answered before the end of the second ring, the phone won't have time to announce the caller's information.
- Pronunciation of names may vary with this feature. Not all names may be pronounced correctly.
- Caller ID announce is available in English only.

Dial modes

Set dial mode

The dial mode is preset to touch-tone dialing. If you have pulse (rotary) service, you need to change the dial mode to pulse dialing before using the telephone to make a call.

Using a cordless handset or telephone base:

1. Press **MENU/SELECT** when the phone is not in use.
2. Press **▼CID** or **▲**  to choose **Settings**, and then press **MENU/SELECT** to select.
3. Press **▼CID** or **▲**  to choose **Dial mode**, and then press **MENU/SELECT** to select.
4. Press **▼CID** or **▲**  to choose **Touch-tone** or **Pulse**, and then press **MENU/SELECT** to select.

Temporary tone dialing

If you have pulse (rotary) service only, you can switch from pulse to touch-tone dialing temporarily during a call. This is useful if you need to send touch-tone signals to access your telephone banking or long distance services.

Using a cordless handset or telephone base:

1. During a call, press **X** TO NE.
2. Use the dialing keys to enter the number.
 - The telephone sends touch-tone signals.
 - The telephone automatically returns to pulse dialing mode after you end the call.





Ringer

Set number of rings

You can set the answering system to answer an incoming call after two, three, four, five or six rings; or toll saver.

If you choose toll saver, the answering system answers a call after two rings when you have new messages, or after four rings when you have no new messages. This enables you to check for new messages and avoid paying unnecessary long distance charges if you are calling from outside your local area. By default, the answering system answers an incoming call after three rings.

Using a cordless handset or telephone base:

1. Press **MENU/SELECT** when the phone is not in use.
2. Press **▼CID** or **▲**  to choose **Answering sys**, and then press **MENU/SELECT**.
3. Press **▼CID** or **▲**  to choose **Ans sys setup**, and then press **MENU/SELECT**.
4. Press **▼CID** or **▲**  to highlight **# of rings**, then press **MENU/SELECT**.
5. Press **▼CID** or **▲**  to choose from **6, 5, 4, 3, 2** or **Toll saver**.
 - Toll saver - the answering system answers a call after two rings when you have new messages, or after

four rings when there is no new message. This feature allows you to check for new messages and avoid paying long distance charges when calling from out of your local area.

6. Press **MENU/SELECT** to save.

Set ringer tone

You can select the ringer tones for incoming home and cell calls.

Using a cordless handset or telephone base:

To set the ringer tone on home line:

1. Press **MENU/SELECT** in idle mode.
2. Press **▼CID** or **▲** to highlight **Ringers**, then press **MENU/SELECT**.
3. Press **▼CID** or **▲** to select **Home ringtone**, then press **MENU/SELECT**.
4. Press **▼CID** or **▲** to sample each ring tone for home line.
5. Press **MENU/SELECT** to save.

To set the ringer tone on cell lines:

1. Press **MENU/SELECT** in idle mode.
2. Press **▼CID** or **▲** to highlight **Ringers**, then press **MENU/SELECT**.
3. Press **▼CID** or **▲** to select **Cell ringtone**, then press **MENU/SELECT**.
4. Press **▼CID** or **▲** to sample each ring tone for cell lines.
5. Press **MENU/SELECT** to save.

NOTE

- If you turn off the ringer volume, you will not hear ringer tone samples.

Set ringer volume

You can select the ringer volume for incoming home and cell calls. When the ringer is off,  appears on the screen.

Using a cordless handset or telephone base:

To set the ringer volume on home line:

1. Press **MENU/SELECT** in idle mode.
2. Press **▼CID** or **▲** to highlight **Ringers**, then press **MENU/SELECT**.
3. Press **▼CID** or **▲** to select **Home volume**, then press **MENU/SELECT**.
4. Press **▼CID** or **▲** to sample each ringer volume for home line.
5. Press **MENU/SELECT** to save.

To set the ringer volume on cell lines:

1. Press **MENU/SELECT** in idle mode.
2. Press **▼CID** or **▲** to highlight **Ringers**, then press **MENU/SELECT**.
3. Press **▼CID** or **▲** to select **Cell volume**, then press **MENU/SELECT**.
4. Press **▼CID** or **▲** to sample each ring volume for cell lines.
5. Press **MENU/SELECT** to save.

Telephone base ringer volume

When the telephone base is idle, press **VOL +** or **VOL -** on the telephone base to adjust the ringer volume.

When you set the ringer volume to zero, the base ringer is off and the telephone base displays **Ringer off**.

NOTE

- Changing the handset ringer volume does not affect base ringer volume.
- If the ringer volume is set to off, that handset or the telephone base is silenced for all incoming calls.
- The ringer volume level also determines the ringer levels of intercom calls.

Sound settings

Set listening volume

To adjust the listening volume on a cordless handset

- During a call, press **VOL▼** or **VOL▲**.

To adjust the listening volume at the telephone base

- During a call, press **VOL -** or **VOL +** on the telephone base.



NOTES

- The handset and speakerphone volume settings are independent.
- When the volume reaches the minimum or maximum setting, you hear two beeps.

Set key tone

You can turn the key tone on or off for each handset and the telephone base. If you turn the key tone off, there are no beeps when you press the keys.

Using a cordless handset or telephone base:

1. Press **MENU/SELECT** in idle mode.
2. Press **▼CID** or **▲** to highlight **Settings**, then press **MENU/SELECT**.
3. Press **▼CID** or **▲** to select **Key tone**, then press **MENU/SELECT**.
4. Press **▼CID** or **▲** to select the desired volume or **Off**.
5. Press **MENU/SELECT** to save.
 - The screen returns to the previous menu.
 - You hear a confirmation tone.

Set QUIET mode

You can turn on the quiet mode for a period of time (1-12 hours). During this period, all tones (except paging tone) are muted. When you turn on the quiet mode, the answering system turns on automatically.

To set the duration and turn on the quiet mode

Using a cordless handset or telephone base:

1. Press and hold **#**_{QUIET} when the phone is not in use.
2. The screen displays **Quiet: _ _ hours**. Use the dialing keys (**0-9**) to enter the desired duration (**1-12**).
3. Press **MENU/SELECT** to save.
 - You hear a confirmation tone.
 - The screen displays **Quiet mode on** and .

To turn off the quiet mode

- Press and hold **#**_{QUIET} when the phone is not in use. The screen displays **Quiet mode off** briefly and then returns to idle.

NOTE

- When you change the settings of the ringer tone or ringer volume, you can still hear the samples even if the quiet mode is on.

Answering system settings

Set your built-in answering system

The answering system can record and store up to 99 messages. Each message can be up to three minutes in length. The total storage capacity for the announcement, messages and memos is approximately 22 minutes. The actual recording time depends on individual message characteristics.

Your answering system allows you to set your announcement, to save and delete messages, activate call screening, to set number of rings before pick up, and to access remotely.

Voice guide to set up answering system

This feature is an alternative way for you to do the basic setup of the answering system. You can follow the voice guide to record your own announcement, set the number of rings, and set the message alert tone.

To use the voice guide feature:

1. Press **MENU/SELECT** on the telephone base in idle mode.
2. Press **▼CID** or **▲** to scroll to **Answering sys**, then press **MENU/SELECT**.
3. Press **▼CID** or **▲** to scroll to **Voice guide**, then press **MENU/SELECT**. You hear a voice prompt, *"This voice guide will assist you with the basic setup of your answering system."*
4. Set up your answering system by inputting designated numbers, as instructed in the voice guide.

NOTES

- You can press **CANCEL** on the telephone base to quit the voice guide at any time.
- After a power outage, the telephone base prompts you to set the date and time, and Smart call blocker. After these settings are done or skipped, the telephone base then prompts if you want to set up the answering system via voice guide. Press **MENU/SELECT** to start the setup.

Message playback settings

If you have new messages, the telephone plays only the new messages (oldest first). If there are no new messages, the telephone plays back all messages (oldest first).

When playback begins, you hear the total number of messages followed by the date and time of the message. After the last message, the telephone announces, *"End of messages."*

NOTE

- Make sure you **Set date and time** correctly.

Set remote access code

You can set your own remote access code from **00** to **99**.

To change the remote access code:

Using a cordless handset or telephone base:

1. Press **MENU/SELECT** when the phone is not in use.
2. Press **▼CID** or **▲** to choose **Answering sys**, and then press **MENU/SELECT**.
3. Press **▼CID** or **▲** to choose **Ans sys setup**, and then press **MENU/SELECT**.
4. Press **▼CID** or **▲** to highlight **Remote code**, then press **MENU/SELECT**.
5. Use the dialing keys to enter a two-digit number.
-OR-
Press **▼CID** or **▲** to scroll to a desired two-digit number.
6. Press **MENU/SELECT** to confirm.

Screen calls | Call screening

Turn on or off the call screening

Use this feature to choose whether incoming messages can be heard while they are being recorded.

Using a cordless handset or telephone base:

1. Press **MENU/SELECT** when the phone is not in use.
2. Press **▼CID** or **▲** to scroll to **Answering sys** then press **MENU/SELECT** to select.
3. Press **▼CID** or **▲** to scroll to **Ans sys setup** then press **MENU/SELECT** to select.
4. Press **MENU/SELECT** to choose **Call screening**.
5. Press **▼CID** or **▲** to choose **On** or **Off**.
6. Press **MENU/SELECT** to save.
 - You hear a confirmation tone.

Alert setting

Turn on or off the message alert tone

When the message alert tone is set to on, and there is at least one new message, the telephone base beeps every 10 seconds. The message alert tone is preset to off.

Using a cordless handset or telephone base:

1. Press **MENU/SELECT** when the phone is not in use.
2. Press **▼CID** or **▲** to scroll to **Answering sys** then press **MENU/SELECT** to select.
3. Press **▼CID** or **▲** to scroll to **Ans sys setup** then press **MENU/SELECT** to select.
4. Press **▼CID** or **▲** to scroll to **Msg alert tone** then press **MENU/SELECT** to select.
5. Press **▼CID** or **▲** to choose **On** or **Off**.
6. Press **MENU/SELECT** to save.
 - You hear a confirmation tone.

NOTES

- The answering system must be turned on for the message alert tone to be functional.
- Press any key on the telephone base (except **FIND HS**) to temporarily silence the message alert tone.

Voicemail settings [Telephone service provider]

Set speed dial voicemail number

This feature lets you save your voicemail number for quick access when you press and hold the **1** key.

To set your voicemail number:

1. Press **MENU/SELECT** when the phone is not in use.
2. Press **▼CID** or **▲** to scroll to **Settings**, and then press **MENU/SELECT**.
3. Press **▼CID** or **▲** to highlight **Voicemail #**, then press **MENU/SELECT**.
4. Use the dialing keys to enter the voicemail access number (up to 30 digits) provided by your telephone service provider.
 - Press **▼CID** or **▲** to move the cursor to the left or right.
 - Press **MUTE/DELETE/VOICE** on the handset to erase a digit.
 - Press and hold **MUTE/DELETE/VOICE** on the handset to erase all digits.
 - Press and hold **REDIAL/PAUSE** to enter a three-second dialing pause (a **P** appears).
5. Press **MENU/SELECT** to confirm.

Voicemail (visual message waiting) indicator

If you subscribe to a voicemail service offered by your telephone service provider, **New voicemail** and the **1** icon appear on the handset and telephone base screen when you have new voicemail messages. Contact your service provider for more information and assistance about using your voicemail service.

NOTE

- This feature does not indicate new messages recorded on your phone's built-in answering system.

Clear voicemail indicator/indication

Use this feature when the telephone indicates there is new voicemail but there is none. For example, when you have accessed your voicemail while away from home. This feature only turns off the displayed **New voicemail** and the **1** icon; it does not delete your voicemail messages. As long as you have new voicemail messages, your telephone service provider continues to send the signal to turn on the indicator.

To manually turn off the new voicemail indicator:

1. Press **MENU/SELECT** when the phone is not in use.
2. Press **▼CID** or **▲** to scroll to **Settings**, and then press **MENU/SELECT**.
3. Press **▼CID** or **▲** to highlight **Clr voicemail**, then press **MENU/SELECT** to turn the voicemail indicator off.

NOTE

- Your telephone service provider voicemail might alert you to new messages with a stutter (broken) dial tone. Contact your telephone service provider for more details.

Add and register handset

When your handset is deregistered from the telephone base, follow the steps below to register it back to the telephone base.

1. Before you begin registration, make sure the handset is out of the telephone base or charger and shows **To register HS...** and **... see manual**.
2. Put the handset you wish to register on the telephone base cradle.
3. The telephone base shows **Registering... Please wait**, and the handset then shows **Registering...** If the registration is successful, the handset screen displays **Registered** and beeps. The handset is now registered with the telephone base.

If registration fails, the system will automatically try to register again. If registration fails after the third try, **Registration failed** appears on the handset screen. The handset shows **To register HS...** and **...see manual**, and the telephone base returns to idle mode. This may take up to five minutes to occur. Please start again from Step 1.

NOTE

- If your handset is new, make sure you charge it before attempting registration.

Screen messages

Blocked call	An incoming call is blocked.
Calling HS X (For models with two or more handsets only)	The handset is calling another handset (for intercom call)
Ended	You have just ended a call.
Home screening...	The telephone is screening an incoming home call.
HS X is calling (For models with two or more handsets only)	Another handset is calling.
Intercom	The handset is on an intercom call.
Intercom to: (For models with two or more devices only)	You have started the intercom process, and need to enter the number of the device you wish to call.
Line in use	An extension telephone on the same line or one of the handsets is in use.
List empty	There are no phonebook entries or call block list entries.

Low battery	The battery needs to be charged.	Speaker	The handset speakerphone is in use.
Microphone on	Mute is off so the other party can hear your voice.	Voice guide set Smart call blk?	After you install your telephone or power returns following a power outage, the handset and telephone base will prompt you to set the date and time. After the date and time setting is done or skipped, the telephone base will then prompt if you want to set up the Smart call blocker feature via voice guide.
Muted	The microphone is off.	To register HS... see manual	The handset is not registered to any telephone base.
New voicemail	There are new voicemail messages from your telephone service provider.	To screen call press [SELECT]	The system is recording a message. Press MENU/SELECT to screen a call on a handset.
No battery	The handset in the telephone base or charger does not have a battery properly installed.	Unable to call	<ul style="list-style-type: none"> • Intercom failed. • You try to join a call when there are already four handsets on that call. • You try to make a call when the handset is out of range.
No line	There is no telephone line connected.	XX missed calls	There are XX new calls in the caller ID log.
No message	There are no messages in the answering system.	XX new messages	There are XX new messages in the answering system.
Not available	Someone else is already using the phonebook, caller ID log or answering system.		
Number repeated	The telephone number you have entered is already stored in the phonebook.		
Out of range or no pwr at base	The handset has lost communication with the telephone base.		
** Paging **	The telephone base is paging all handsets.		
Smart call blk screening...	The telephone is screening an incoming call.		

Put in charger	The battery is very low. The handset should be placed in the telephone base or charger.
Quiet mode off	The quiet mode is turned off.
Quiet mode on	The quiet mode is turned on.
Rec mem low	The answering system has less than 3 minutes to record.
Rec mem full	The answering system memory is full.
Ringer muted	The ringer is muted temporarily during an incoming call.
Screen all Robocalls	You have selected the Screen robot profile option in Smart call blocker.
Screen all Unknown calls	You have selected the Screen Unknown profile option in Smart call blocker.
Screened call	The Smart call blocker feature of the telephone has screened a call and is putting the call through to you.
Setting Ans sys	The handset is playing voice guide.

General product care

Taking care of your telephone

Your cordless telephone contains sophisticated electronic parts, so it must be treated with care.

Avoid rough treatment

Place the handset down gently. Save the original packing materials to protect your telephone if you ever need to ship it.

Avoid water

Your telephone can be damaged if it gets wet. Do not use the handset outdoors in the rain, or handle it with wet hands. Do not install the telephone base near a sink, bathtub or shower.

Electrical storms

Electrical storms can sometimes cause power surges harmful to electronic equipment. For your own safety, take caution when using electrical appliances during storms.

Cleaning your telephone

Your telephone has a durable plastic casing that should retain its luster for many years. Clean it only with a dry non-abrasive cloth. Do not use dampened cloth or cleaning solvents of any kind.

Technical specifications

Frequency control	<ul style="list-style-type: none"> Crystal controlled PLL synthesizer
Transmit frequency	<ul style="list-style-type: none"> Handset: 1921.536-1928.448 MHz Telephone base: 1921.536-1928.448 MHz
Channels	<ul style="list-style-type: none"> 5
Nominal effective range	<ul style="list-style-type: none"> Maximum power allowed by FCC and IC. Actual operating range may vary according to environmental conditions at the time of use.
Power requirement	<ul style="list-style-type: none"> Handset: 2.4V Ni-MH battery Telephone base: 6V DC @ 600mA Charger: 6V DC @ 400mA
Memory	<ul style="list-style-type: none"> Phonebook: 1200 memory locations; up to 30 digits and 15 characters Caller ID log: 50 memory locations; up to 24 digits and 15 characters Call block: 1000 entries

When it is fully charged, you can expect the following performance.

Operation	Operating time*
Talk time (cordless handset)	<ul style="list-style-type: none"> 10 hours
Standby	<ul style="list-style-type: none"> 5 days

* Operating times vary depending on your actual use and the age of the battery.

DECT 6.0 digital technology

The VTech DECT 6.0 products offer unsurpassed range performance and sound clarity. This is achieved through a unique antenna design and advances in noise-filtering technology. An independent laboratory has confirmed that VTech DECT 6.0 products perform up to 45% better in range competitions against similarly equipped phones of the leading competition. Now, calls can be taken in the basement, backyard and garage with exceptional sound quality.

Telephone operating range

This cordless telephone operates within the maximum power allowed by the Federal Communications Commission (FCC). Even so, this handset and telephone base can communicate over a certain distance – which can vary with the locations of the telephone base and handset, the weather, and the construction of your home or office.

Redefining long range coverage and clarity

This telephone base comes with an antenna which gives much better clarity and covers a longer range than before.

Simulated full-duplex handset and base speakerphones

The simulated full-duplex speakerphone on your handset and telephone base allow both ends of a call to speak and be heard at the same time. Optimal performance is subject to external factors and individual usage.

Frequently asked questions

Below are the questions most frequently asked about the cordless telephone. If you cannot find the answer to your question, visit our website at www.vtechphones.com or call **1 (800) 595-9511** for customer service. In Canada, go to phones.vtechcanada.com or call **1 (800) 267-7377**.

My telephone does not work at all.	Make sure the telephone base is installed properly, and battery is installed and charged correctly. For optimum daily performance, return the handset to the telephone base after use.
The display shows No line. I cannot hear the dial tone.	<p>Disconnect the telephone line cord from your telephone and connect it to another telephone. If there is no dial tone on that other telephone either, then the telephone line cord may be defective. Try installing a new telephone line cord.</p> <p>If changing the telephone line cord does not help, the wall jack (or the wiring to this wall jack) may be defective. Contact your telephone service provider.</p> <p>You may be using a new cable or VoIP service, the existing telephone jacks in your home may no longer work. Contact your service provider for solutions.</p>
I cannot dial out.	<p>Make sure there is a dial tone before dialing. It is normal if the handset takes a second or two to synchronize with the telephone base before producing a dial tone. Wait an extra second before dialing.</p> <p>Eliminate any background noise. Mute the handset before dialing, or dial from another room in your home with less background noise.</p>

Disclaimer and Limitation of Liability

VTech Communications, Inc. and its suppliers assume no responsibility for any damage or loss resulting from the use of this user's manual. VTech Communications, Inc. and its suppliers assume no responsibility for any loss or claims by third parties that may arise through the use of this product.

Company: VTech Communications, Inc.
Address: 9020 SW Washington Square Road - Ste 555 Tigard, OR 97223, United States

Phone: 1 (800) 595-9511 in the U.S. or 1 (800) 267-7377 in Canada

Limited Warranty

What does this limited warranty cover?

The manufacturer of this VTech Product warrants to the holder of a valid proof of purchase ("Consumer" or "you") that the Product and all accessories provided in the sales package ("Product") are free from defects in material and workmanship, pursuant to the following terms and conditions, when installed and used normally and in accordance with the Product operating instructions. This limited warranty extends only to the Consumer for Products purchased and used in the United States of America and Canada.

What will VTech do if the Product is not free from defects in materials and workmanship during the limited warranty period ("Materially Defective Product")?

During the limited warranty period, VTech's authorized service representative will replace at VTech's option, without charge, a Materially Defective Product. If we replace the Product, we may use new or refurbished replacement parts. If we choose to replace the Product, we may replace it with a new or refurbished Product of the same or similar design. We will retain defective parts, modules, or equipment. Replacement of the Product, at VTech's option, is your exclusive remedy. VTech will return the replacement Products to you in working condition. You should expect the replacement to take approximately 30 days.

How long is the limited warranty period?

The limited warranty period for the Product extends for ONE (1) YEAR from the date of purchase. If VTech replaces a Materially Defective Product under the terms of this limited warranty, this limited warranty also applies to the replacement Product for a period of either (a) 90 days from the date the replacement Product is shipped to you or (b) the time remaining on the original one-year warranty; whichever is longer.

What is not covered by this limited warranty?

This limited warranty does not cover:

1. Product that has been subjected to misuse, accident, shipping or other physical damage, improper installation, abnormal operation or handling, neglect, inundation, fire, water or other

liquid intrusion.

2. Product that has been subjected to contact with liquid, water, rain, extreme humidity or heavy perspiration, sand, dirt or the like; but then only to the extent the damage was not caused by incorrectly securing the waterproof handset's protective elements, for example, failing to properly close a seal), or such protective elements are damaged or missing (e.g. a cracked battery door), or subjecting a Product to conditions beyond its stated specifications or limits (e.g. 30 minutes in 1 meter of fresh water).
3. Product that has been damaged due to repair, alteration or modification by anyone other than an authorized service representative of VTech;
4. Product to the extent that the problem experienced is caused by signal conditions, network reliability, or cable or antenna systems;
5. Product to the extent that the problem is caused by use with non-VTech accessories;
6. Product whose warranty/quality stickers, product serial number plates or electronic serial numbers have been removed, altered or rendered illegible;
7. Product purchased, used, serviced, or shipped for repair from outside the United States of America or Canada, or used for commercial or institutional purposes (including but not limited to Products used for rental purposes);
8. Product returned without a valid proof of purchase (see item 2 below); or
9. Charges for installation or set up, adjustment of customer controls, and installation or repair of systems outside the unit.

How do you get warranty service?

To obtain warranty service in Canada, go to phones.vtechcanada.com or dial 1 (800) 267-7377.

NOTE: Before calling for service, please review the user's manual - a check of the Product's controls and features may save you a service call.

Except as provided by applicable law, you assume the risk of loss or damage during transit and transportation and are responsible for delivery or handling charges incurred in the transport of the Product(s) to the service location. VTech will return replaced Product

under this limited warranty. Transportation, delivery or handling charges are prepaid.

VTech assumes no risk for damage or loss of the Product in transit. If the Product failure is not covered by this limited warranty, or proof of purchase does not meet the terms of this limited warranty, VTech will notify you and will request that you authorize the cost of replacement prior to any further replacement activity. You must pay for the cost of replacement and return shipping costs for the replacement of Products that are not covered by this limited warranty.

What must you return with the Product to get warranty service?

1. Return the entire original package and contents including the Product to the VTech service location along with a description of the malfunction or difficulty; and
2. Include a "valid proof of purchase" (sales receipt) identifying the Product purchased (Product model) and the date of purchase or receipt; and
3. Provide your name, complete and correct mailing address, and telephone number.

Other limitations

This warranty is the complete and exclusive agreement between you and VTech. It supersedes all other written or oral communications related to this Product. VTech provides no other warranties for this Product. The warranty exclusively describes all of VTech's responsibilities regarding the Product. There are no other express warranties. No one is authorized to make modifications to this limited warranty and you should not rely on any such modification.

State/Provincial Law Rights: This warranty gives you specific legal rights, and you may also have other rights, which vary from state to state or province to province.

Limitations: Implied warranties, including those of fitness for a particular purpose and merchantability (an unwritten warranty that the Product is fit for ordinary use) are limited to one year from the date of purchase. Some states/provinces do not allow limitations on

how long an implied warranty lasts, so the above limitation may not apply to you. In no event shall VTech be liable for any indirect, special, incidental, consequential, or similar damages (including, but not limited to lost profits or revenue, inability to use the Product or other associated equipment, the cost of substitute equipment, and claims by third parties) resulting from the use of this Product. Some states/provinces do not allow the exclusion or limitation of incidental or consequential damages, so the above limitation or exclusion may not apply to you.

Please retain your original sales receipt as proof of purchase

Go to www.vtechphones.com **(US)** to register your product for enhanced warranty support and the latest VTech product news.

Go to phones.vtechcanada.com **(Canada)** for the latest VTech product news.



Specifications are subject to change without notice.

© 2023 VTech Communications, Inc. |

© 2023 VTech Technologies Canada Ltd.

All rights reserved. v2. 04/23.