

Go to www.vtechbabycare.com to register your product for enhanced warranty support and the latest Vtech product news.

VM924, VM924-2
VM924-3, VM924-4

Pan and Tilt
Video Baby Monitor

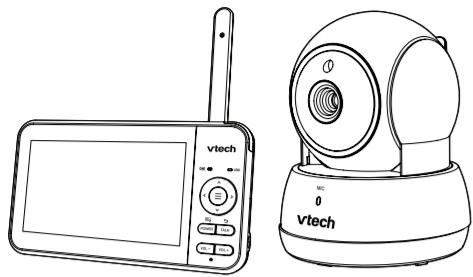

For more support information

vtech

Quick start guide



TECHNICAL SPECIFICATIONS

Frequency control	Crystal controlled PLL synthesizer
Transmit frequency	Baby unit: 2405 - 2475 MHz Parent unit: 2405 - 2475 MHz
Channels	32
LCD	5" Color LCD (WQVGA 480x272 pixel)
Nominal effective range	Maximum power allowed by FCC and IC. Actual operating range may vary according to environmental conditions at the time of use.
Power requirements	Parent unit: 3.6V, 2600mAh, 9.36Wh Li-ion battery Baby unit power adapter: Output: 5V DC @ 1A Parent unit power adapter: Output: 5V DC @ 1A

IMPORTANT SAFETY INSTRUCTIONS

- The applied nameplate is located at the bottom of the baby unit base. When in use, basic safety precautions should always be followed to reduce the risk of fire, electric shock and injury, including the following:
- Follow all warnings and instructions marked on the product.
 - Adult setup is required.
 - CAUTION:** Do not install the baby unit at a height above 6.5 feet (2 meters).
 - This product is intended as an aid. It is not a substitute for responsible and proper adult supervision and should not be used as such.
 - This product is not intended for use as a medical monitor.
 - Do not use this product near water, for example, near to a bath, sink, swimming pool or shower.
 - CAUTION:** Use only the internal, non-user replaceable battery fitted to the parent unit. There may be a risk of explosion if a wrong type of battery is used for the parent unit. The battery cannot be subjected to high or low extreme temperature and low air pressure at high altitude during use, storage or transportation. Disposal of batteries in fire or a hot oven, mechanically crushing or cutting the battery can result in an explosion. Subjecting products or batteries to an extremely high temperature environment can result in explosion or leakage of flammable liquids, or gas. Products or batteries subjected to extremely low air pressures may result in explosion or leakage of flammable liquids, or gas. Dispose of used batteries according to the information in **The RRBC seal**.
 - Use only the power adapters supplied with this product. Incorrect power adapter polarity or voltage can seriously damage the product.
 - Power adapter information: Output: 5V DC 1A
Vtech Telecommunications Ltd.
Model: VT05EUS05100
 - OR-
Jiangxi Jian Aohai Technology Co., Ltd
Model: A318-050100W-US2
 - Rechargeable battery information: Zhuhai Great Power Energy Co., Ltd.
Li-ion battery, 3.6V, 2600mAh, 9.36Wh;
Model: ICR18650-2.6Ah-3.6V-1S1P
 - The power adapter is intended to be correctly oriented in a vertical or floor mount position. The prongs are not designed to hold the plug in place if it is plugged into a ceiling, under-the-table or cabinet outlet.
 - For pluggable equipment, the socket-outlet (power adapter) should be installed near the equipment and should be easily accessible.
 - Unplug this product from the wall outlet before cleaning. Do not use liquid or aerosol cleaners. Use a damp cloth for cleaning.
 - Do not modify the power adapters or replace with other third-party adapters.
 - Do not allow anything to rest on the power cords. Do not install this product where the cords may be walked on or damaged.
 - The product should only be operated from a power source indicated on the power adapter label or marking. If you are unsure of the type of power supply in your home, consult your dealer or electricity supply provider.
 - Do not overload wall outlets or use an extension cord.
 - Do not place this product on an unstable table, shelf, stand or other unstable surfaces.
 - This product should not be placed in any area where proper ventilation is not provided. Any slots or openings in the back or bottom of this product are provided for ventilation. To protect from overheating, openings must not be blocked by placing the product on a soft surface such as a bed, sofa or rug. This product should never be placed near or over a radiator or heat source.
 - Never insert any objects through any apertures or slots in the product as this can be dangerous and cause damage to the

- battery or other internal parts. Never spill any liquids on the product.
- To reduce the risk of electric shock, do not disassemble this product, but take it to an authorized service facility. Disassembly or removing parts of the product other than battery replacement via a battery door (if applicable) may expose dangerous voltages or other risks.
 - You should test the sound reception every time you turn on the units or move one of the components.
 - Periodically examine all components for damage.
 - There is a very low risk of privacy loss when using certain electronic devices, such as baby monitors, cordless telephones, etc. To protect your privacy, make sure the product has never been used before purchase, reset the baby monitor periodically by powering off and then powering on the units, and power off the baby monitor if you are not intending to use it for some time.
 - Children should be supervised to ensure that they do not play with the product.
 - The small parts of this monitor can be swallowed by babies or small children. Keep these parts out of reach of children.
 - The product is not intended for use by persons (including children) with reduced physical, sensory or mental capabilities, or lack of experience and/or instruction, unless they have been given supervision or instruction concerning use of the appliance by a person responsible for their safety.

SAVE THESE INSTRUCTIONS

- Cautions**
- Use and store the product at a temperature between 32°F (0°C) and 104°F (40°C).
 - Mishandling batteries can cause burn, fire or explosion hazards.
 - Batteries should not be exposed to excessive heat such as bright sunshine or fire.
 - Do not expose the product to extreme cold, heat or direct sunlight. Do not place the product close to a heating source.

- Warnings—Strangulation Hazard—** Children have STRANGLED in cords. Keep this cord out of the reach of children (more than 3 ft (0.9m) away). Do not remove warning label on the adapter cord.
- Never place the baby's crib or playpen. Never cover the baby unit(s) or parent unit with anything such as a towel or a blanket.
 - Other electronic products can cause interference to your parent unit and baby unit. Try installing your baby unit as far away as possible from the following electronic devices: wireless routers, radios, mobile telephones, intercoms, room monitors, televisions, personal computers, kitchen appliances (e.g. microwave ovens) and cordless telephones.

Precautions for users of implanted cardiac pacemakers
Cardiac pacemakers (applies only to digital cordless devices): Wireless Technology Research, LLC (WTR), an independent research entity, led a multidisciplinary evaluation of the interference between portable wireless devices and implanted cardiac pacemakers. Supported by the U.S. Food and Drug Administration, WTR recommends to physicians that:

- Pacemaker patients**
- Should keep wireless devices at least six inches from the pacemaker.
 - Should NOT place wireless devices directly over the pacemaker, such as in a breast pocket, when it is turned ON. WTR's evaluation did not identify any risk to bystanders with pacemakers from other persons using wireless devices.

Electromagnetic fields (EMF)
This Vtech product complies with all standards regarding electromagnetic fields (EMF). If handled properly and according to the instructions in this user's manual, the product is safe to be used based on scientific evidence available today.

WHAT'S IN THE BOX

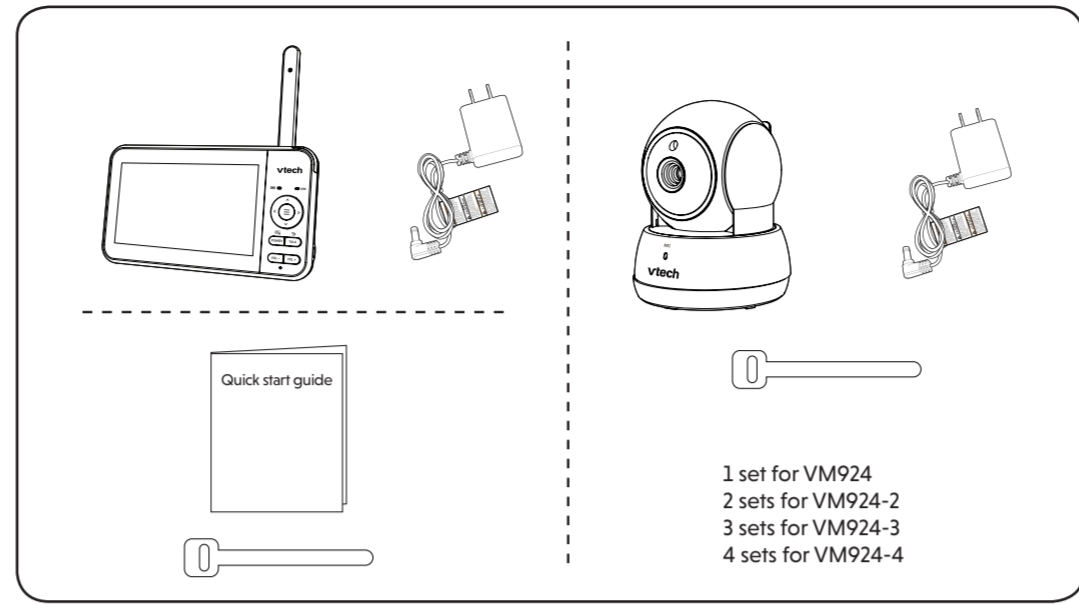

- 1 set for VM924
- 2 sets for VM924-2
- 3 sets for VM924-3
- 4 sets for VM924-4

1 CONNECT THE BABY MONITOR

NOTES

- The rechargeable battery in the parent unit is built-in.
- Use only the power adapters supplied with this product.
- Make sure the parent unit and the baby unit are not connected to an electronically controlled electric power outlet.
- Connect the power adapters in a vertical or floor mount position only. The adapters' prongs are not designed to hold the weight of baby monitor, so do not connect them to any ceiling, under-the-table, or cabinet outlets. Otherwise, the adapters may not properly connect to the outlets.
- Make sure the parent unit, the baby units and the power adapter cords are out of reach of children.

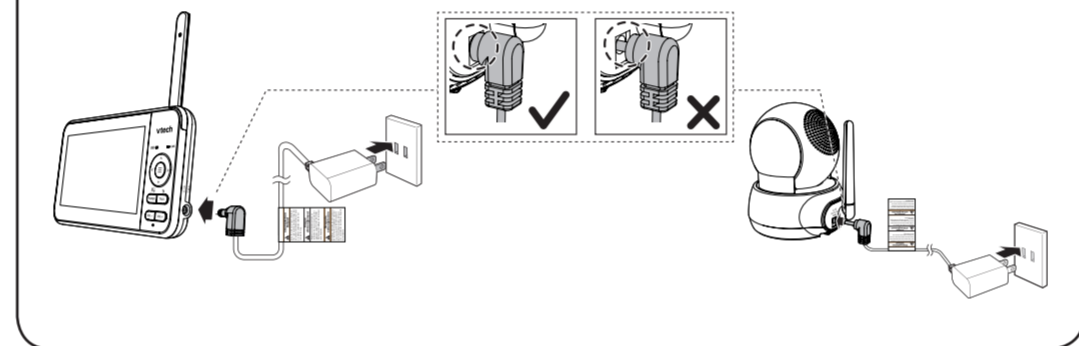

1 CONNECT THE BABY MONITOR (CONT'D)

Charge the parent unit battery
When you have connected and turned on the parent unit, the battery will be charged automatically.

NOTES

- Before using the baby monitor for the first time, charge the parent unit battery for 12 hours. When the parent unit battery is fully charged, the battery icon segment are solid.
- It takes longer to charge the battery when the parent unit is turned on. To shorten the charging time, turn the parent unit off while charging.
- The standby time varies depending on the sensitivity level you set, your actual use and the age of the battery.

The battery icon indicates the battery status (see the following table).

BATTERY INDICATORS	BATTERY STATUS	ACTION
The screen displays . The light flashes.	The battery has very little power and can only be used for a short time.	Charge without interruption (about 30 minutes).
The battery icon segments are solid .	The battery is fully charged.	To keep the battery charged, connect the unit to AC power when in use.

2 POWER ON OR OFF THE BABY MONITOR

- Slide the **ON/OFF** switch to power on or off your baby unit.
- Press and hold **POWER** to power on or off your parent unit.

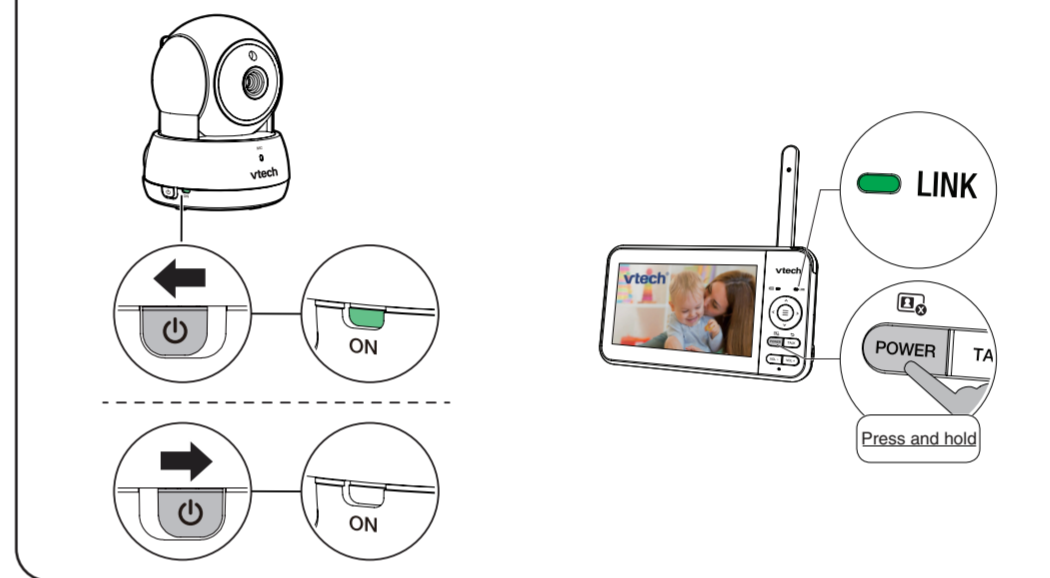

3 POSITIONING THE BABY MONITOR

- Keep the baby unit out of the reach of your baby. Never place or mount the baby unit inside the baby's crib or playpen.
 - CAUTION**
- The default volume of your parent unit is level 4, and the maximum volume is level 7. If you experience any feedback noise from your baby monitor while positioning:
 - Make sure your baby unit and parent unit are more than 3 feet (1 meter) apart, OR
 - Turn down the volume of your parent unit.
- To avoid interference from other electronic devices, place your baby monitor at least 3 feet (1 meter) away from devices such as wireless routers, microwave ovens, mobile phones and computers.
 - NOTE**

4 STATUS CHECK

Once you power on both your baby unit and parent unit, your parent unit displays image from the baby unit, and the **LINK** LED light turns on.

The baby unit's **POWER** LED light turns on.



BASIC OPERATION - PARENT UNIT

Use the menu

Press to enter the menu, choose a menu item, or save a setting. You can use the parent unit for advanced settings or operations, such as to play or stop the baby unit lullaby, or to adjust the baby unit sound sensitivity.

While in the menu:

- Press or to scroll among the menu options.
- Press to select an item, or to save a setting.
- Press or to scroll among the sub-menus, or to adjust a setting.
- Press to return to the previous menu options without changing the current setting.
- Press TALK to return to live video.

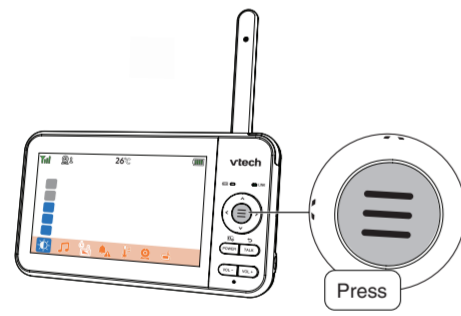

Talk to your baby unit

Press and hold **TALK** and speak to your parent unit. Your voice is transmitted to the baby unit. Release **TALK** when finished talking to hear your baby again.

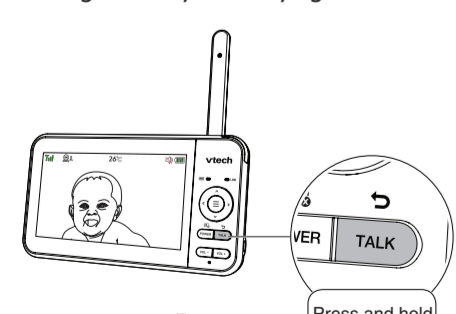

Turn off the screen

Press POWER to turn off the parent unit screen without powering off the parent unit. You will still hear sounds from the baby unit.

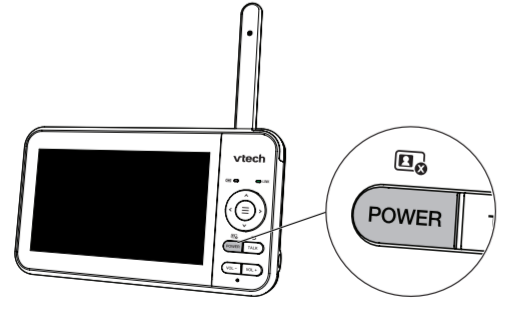

TIP

- Press any key on the parent unit to turn the screen on again.

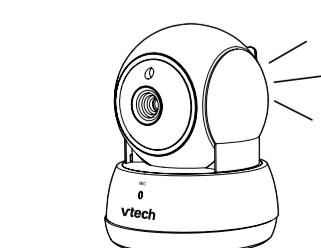

Adjust parent unit volume

Press **VOL - / VOL +** to adjust your parent unit speaker volume.

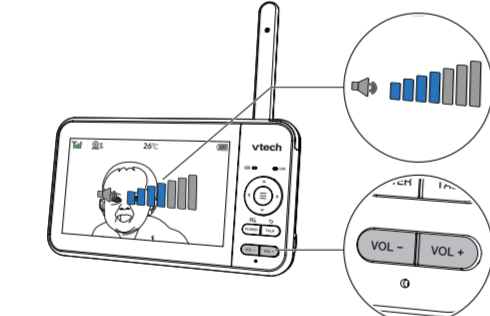

Pan and tilt the baby unit

Press **Arrow keys** to pan and tilt the baby unit.

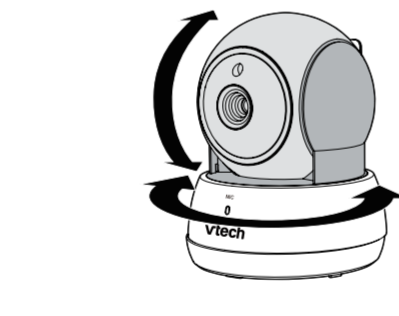

OVERVIEW - PARENT UNIT

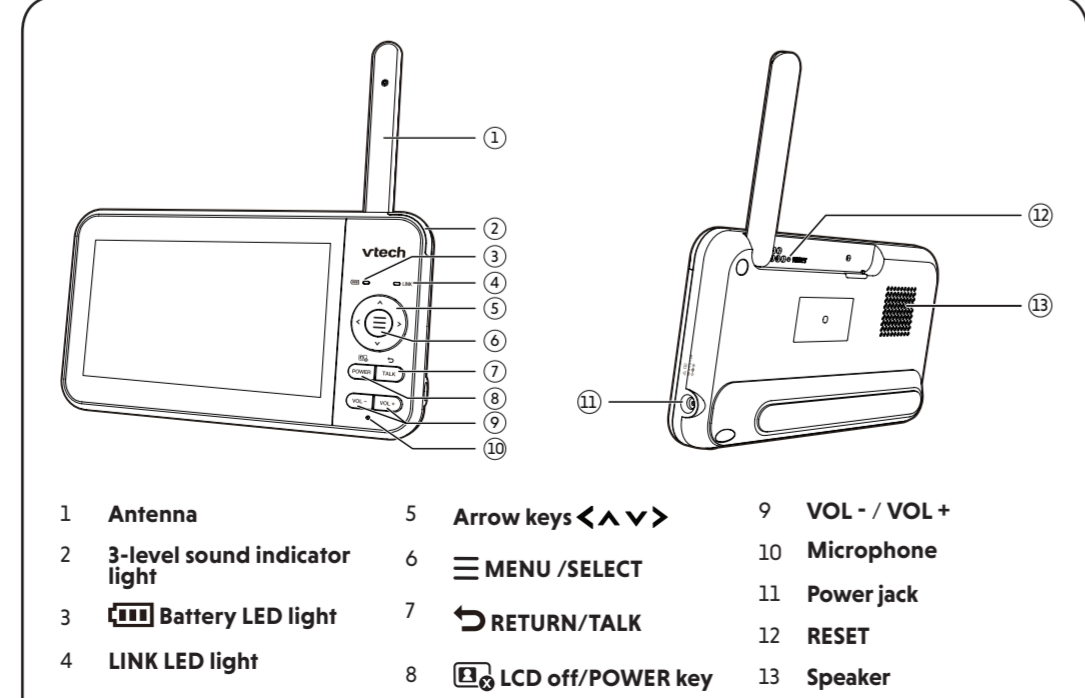

OVERVIEW - BABY UNIT

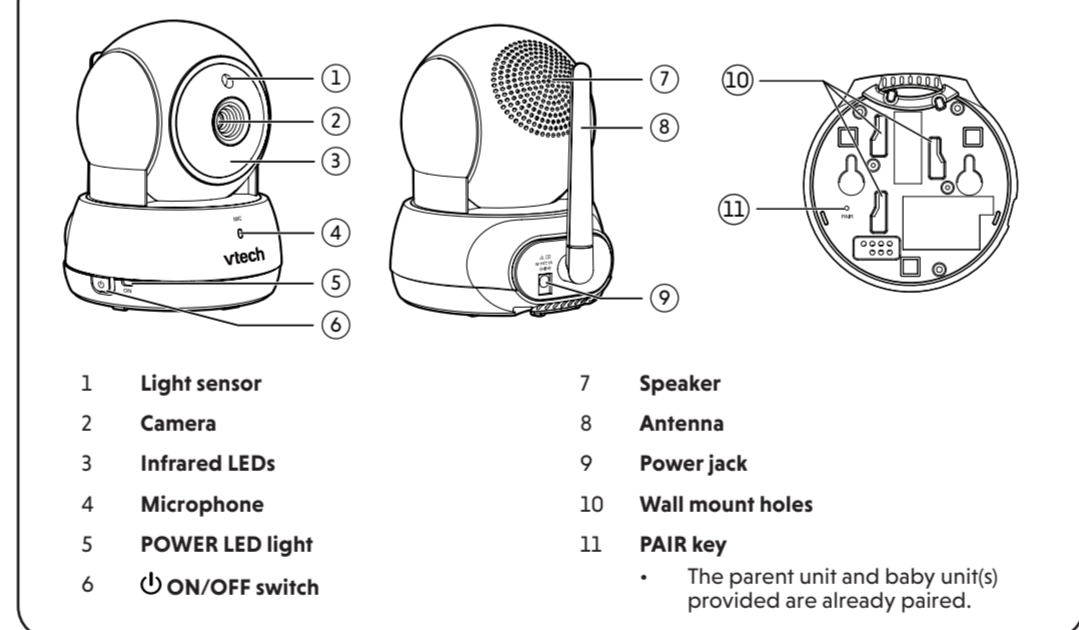

NEED HELP?

For operations and guides to help you use your video monitor, and for the latest information and support, check out our online help topics and online FAQs.

Use your smartphone or mobile device to access our online help.

- Go to <https://help.vtechphones.com/vm924>, <https://help.vtechphones.com/vm924-2>, <https://help.vtechphones.com/vm924-3> or <https://help.vtechphones.com/vm924-4> OR
- Scan the QR code on the right. Launch the camera app or QR code scanner app on your smartphone or tablet. Hold the device's camera up to the QR code and frame it. Tap the notification to be redirected to the online help page.
- If the QR code is not clearly displayed, adjust your camera's focus by moving your device closer or further away until the image is clear.

If you would like to contact us, visit <https://help.vtechphones.com/cs>.

You can also call our Customer Support at 1 (800) 595-9511 [in US] or 1 (800) 267-7377 [in Canada] for help.



PARENT UNIT ICONS

Main menu icons

- | Main menu | Sub-menu |
|-------------------|--|
| Brightness | Adjust the parent unit LCD brightness. |
| Lullaby | <ul style="list-style-type: none"> Play/Stop lullaby Select one of the soothing sounds, or white noise. Melodies Select one of the five melodies. Play all melodies. 60min 45min 30min 15min OFF Set timer to stop playing the selected melody or soothing sound. |

- | Main menu | Sub-menu |
|----------------------------|--|
| Screen off Timer | <ul style="list-style-type: none"> OFF 5min 30min 60min The parent unit screen will turn off after the selected time to save energy. You can still hear your baby while the screen is turned off. AUTO Sound Sensitivity When AUTO is selected, the parent unit screen will automatically turn on when detected sounds exceed a set level. You can adjust the baby unit microphone sensitivity level so that the higher the sensitivity level, the more sensitive the baby unit is in detecting sounds for transmitting to the parent unit. For details, see the Sound sensitivity and sound activation section. The parent unit will then turn off again after 50 seconds if the sound detected is lower than the set level. |
| Alert Tone Settings | <ul style="list-style-type: none"> Set the parent unit to beep when the battery is low. Set the parent unit to beep when the link between the parent unit and the baby unit is lost. Set the confirmation tone on or off when selecting an option in the menus. Set the parent unit to beep when the baby unit detects sounds while in Split mode (For pairing with VM924-2, VM924-3, VM924-4). |

- | Main menu | Sub-menu |
|---------------------------|---|
| Temperature | <ul style="list-style-type: none"> ON/ OFF Turn on/off temperature alert tone. Set the parent unit to beep whenever the room temperature detected by the baby unit falls outside of the set temperature range. Set the minimum temperature. Set the maximum temperature. Set temperature display in Fahrenheit (°F) or Celsius (°C). |
| Baby Unit Settings | <ul style="list-style-type: none"> Baby unit speaker volume Adjust the baby unit speaker volume. Zoom in. |

Monitoring Mode (For pairing with VM924-2, VM924-3, VM924-4)

- Single CAM mode**
The screen displays images only from the selected baby unit in full screen.
- Split mode**
The screen displays images from multiple or all selected baby units at the same time in split view.
- Patrol mode**
The screen displays a single cam view that transitions to a different baby unit every 10 seconds.

☎️ PARENT UNIT ICONS (CONT'D)

Status icons

- Connection status**
- 🟢 - Strong signal strength.
 - 🟡 - Moderate signal strength.
 - 🟠 - Low signal strength.
 - 🔴 - Weak signal strength.

Split mode
(For pairing with **VM924-2, VM924-3, VM924-4**)

Patrol mode
(For pairing with **VM924-2, VM924-3, VM924-4**)

Current view status

- The baby unit number that is being viewed when in:

- **Single CAM mode.**
- **Patrol mode**
(For pairing with **VM924-2, VM924-3, VM924-4**)
- **Split mode**
(For pairing with **VM924-2, VM924-3, VM924-4**)

Status icons

- 🌙 **Night vision** - On
- 🔍 **Zoom** - On
- 🎵 **Lullaby** - On
- °F or °C **Real-time temperature**
 - Real-time temperature detected by the baby unit in Fahrenheit (°F) or Celsius (°C) (e.g. 57°F or 14°C).

Temperature alert tone - On

Talkback - On

- Mute alert**
 - Displays when the parent unit speaker volume is set to off.
 - Displays when the parent unit is talking to the baby unit.

- Battery status**
 - 🔋 animates when the battery is charging.
 - 🔋 - battery is fully charged.
 - 🔋 - battery is low and needs charging.

🔌 CABLE MANAGEMENT

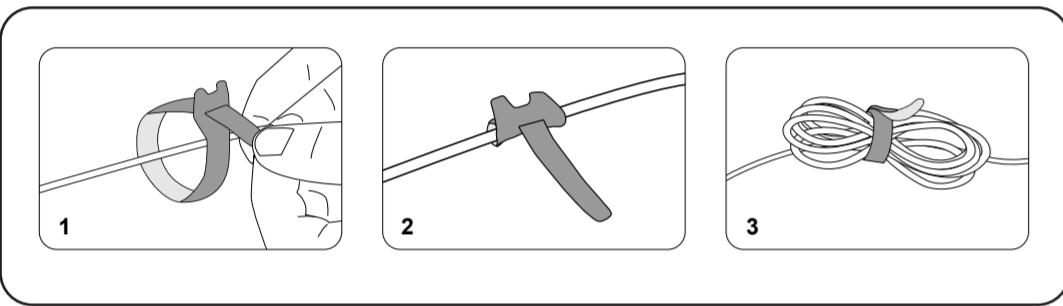

🔊 SOUND SENSITIVITY AND SOUND ACTIVATION

Adjust sound sensitivity level of the baby unit

The parent unit screen will turn on only when the detected sounds exceed a set level.

Use the parent unit to adjust the microphone sensitivity of your baby unit. The higher the sensitivity level, the more sensitive the baby unit is in detecting sounds that transmit to the parent unit. The sound sensitivity level is preset to the highest level.

SOUND SENSITIVITY LEVEL	Level 5 (Highest)	Level 4 (High)	Level 3 (Medium)	Level 2 (Low)	Level 1 (Lowest)
DESCRIPTION	The parent unit screen turns on for quiet sounds, (including background noises) from your baby's room.	The parent unit screen turns on for soft babbling and louder sounds from your baby. It remains off when your baby sleeps soundly.	The parent unit screen turns on for loud babbling and louder sounds from your baby. It remains off when your baby makes soft sounds.	The parent unit screen turns on for crying and louder sounds from your baby. It remains off when your baby makes soft sounds.	The parent unit screen turns on for loud crying or screaming sounds from your baby. It remains off when your baby makes soft sounds.

When **AUTO** is selected, the parent unit screen stays off to save power when the baby unit detects sounds that are lower than the set sensitivity level. Once the baby unit detects sounds that are louder than the set sensitivity level, the parent unit screen turns on automatically. It will then turn off again after 50 seconds if the sounds detected are lower than the set sensitivity level.

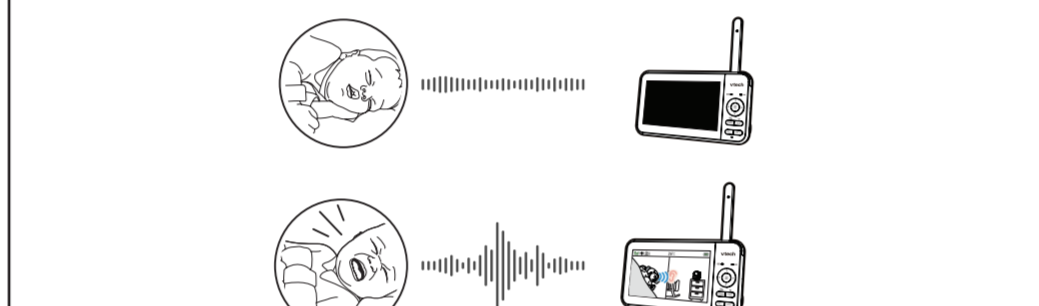

🌙 DIM MODE

Dim mode helps you save parent unit power. When your parent unit is not charging, the display will automatically dim after 10 minutes of inactivity if no keys are pressed or alerts are received from the baby unit.

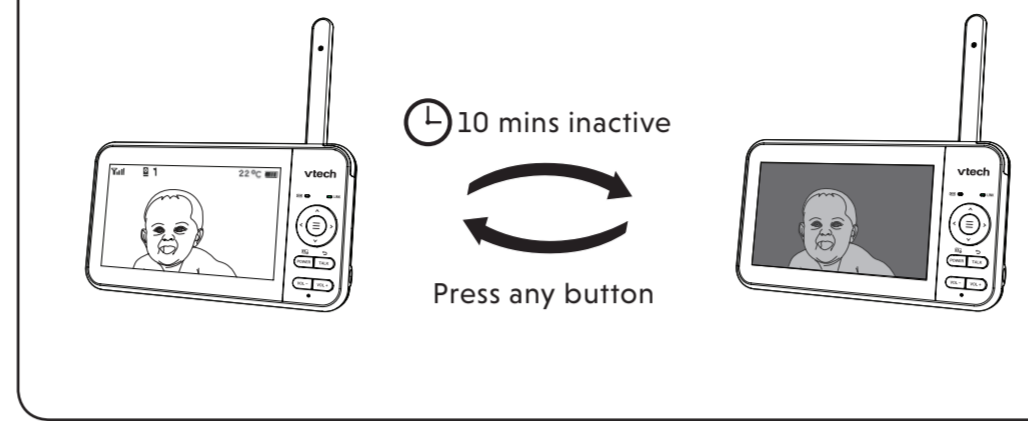

🌙 NIGHT VISION

The baby unit has infrared LEDs that allow you to see your baby clearly at night or in a dark room. When the baby unit detects low light levels, the infrared LEDs are switched on automatically. The images from the baby unit are in black and white, and 🌙 appears on the screen.

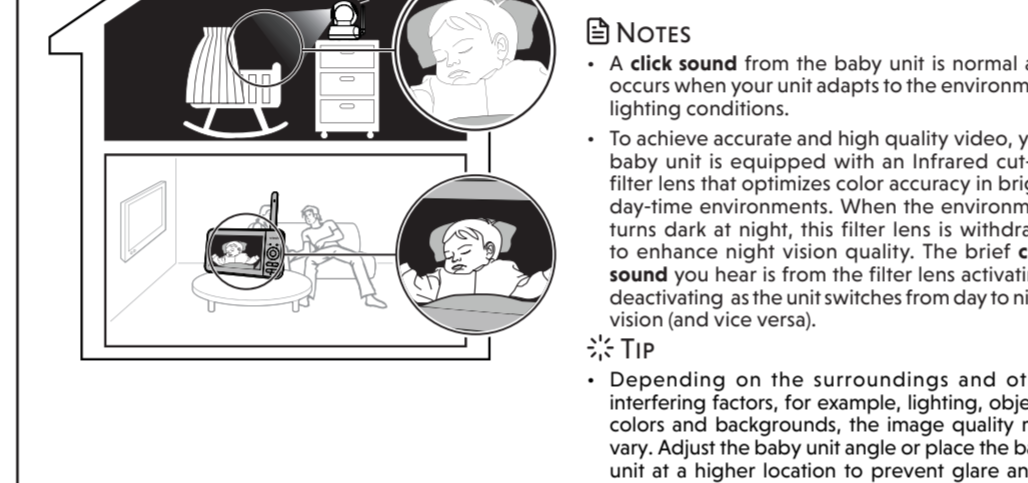

👁️ FOR VM924-2, VM924-3, VM924-4

Status check - Two and more baby units

If you are viewing baby unit 📺 1, the **POWER LED** light of baby unit 📺 1 turns on. As baby unit 📺 2, 📺 3, 📺 4 is not being viewed, its **POWER LED** light flashes.

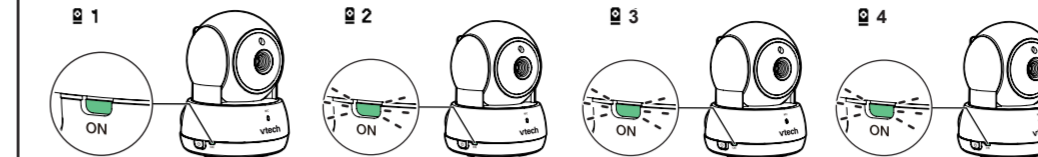

- NOTE**
- If you power on only one baby unit, your parent unit may display 📺 and the **LINK LED** light will flash.

📺 Change different views - Single CAM

To switch among the image of baby units 📺 1, 📺 2, 📺 3, 📺 4:

- Press 📺.
- Enter 📺 **Monitoring mode** menu.
- Select the baby unit you would like to view (📺 1, 📺 2, 📺 3 or 📺 4).

📺 Change different views - Patrol

Select **Patrol** as your monitoring mode to alternately view the image from baby units 📺 1, 📺 2, 📺 3, 📺 4 every 10 seconds.

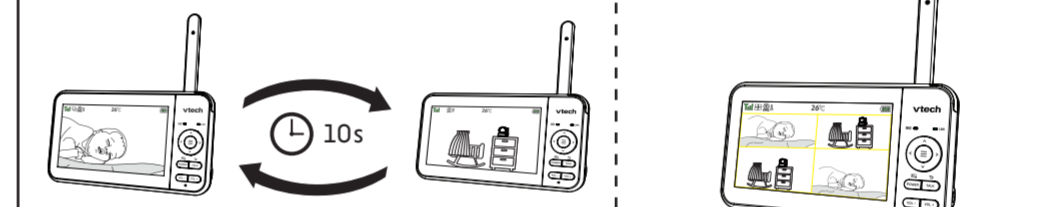

📺 Change different views - Split

Select **Split** as your monitoring mode to view the images from multiple or all selected baby units at once.

🔧 MOUNT THE BABY UNIT (OPTIONAL)

Not Included

You will need to purchase the following items separately to mount your baby unit:

- 2 screws
- 2 anchors

- The screw types and anchors you need depend on the composition of the wall.

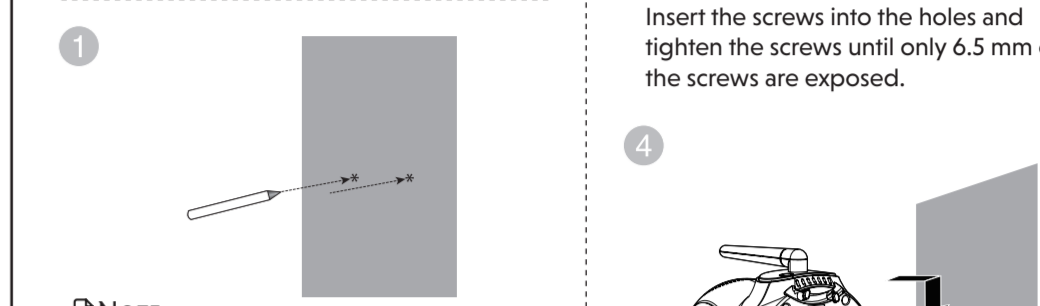

- NOTE**
- Check for reception strength and camera angle before drilling the holes. Use a pencil to mark two holes in parallel. Make sure they are the same distance apart as the wall mount holes on the baby unit.

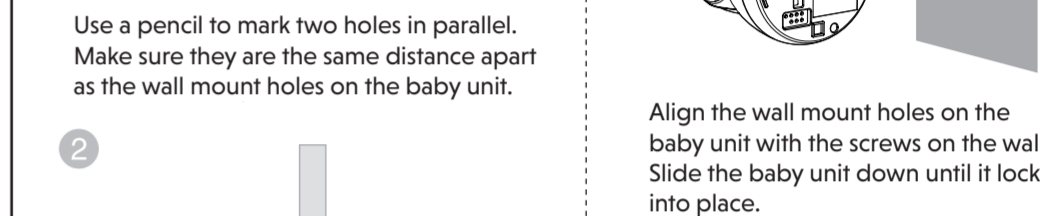

- Align the wall mount holes on the baby unit with the screws on the wall. Slide the baby unit down until it locks into place.
- Drill two holes in the wall. If you drill the holes into a stud, go to step 3.

- OR-**
- If you drill the holes into an object other than a stud, insert the wall anchors into the holes. Tap gently on the ends with a hammer until the wall anchors are flush with the wall.
- Adjust the camera angle.

🗉 FREQUENTLY ASKED QUESTIONS

Below are the questions most frequently asked about the baby monitor.

Why does the baby monitor not respond normally?	Try the following (in the order listed) for common cure: <ol style="list-style-type: none">1. Disconnect the power to the baby units and the parent unit.2. Wait a few seconds before connecting power back to the baby units and the parent unit.3. Turn on the baby units and the parent unit.4. Wait for the parent unit to synchronize with the baby units. Allow up to one minute for this to take place.
Why doesn't my baby unit and parent unit power-on light illuminate when the units are switched on?	Perhaps the parent unit is not connected to the power. Insert the adapter plug into the parent unit and insert the adapter in a wall socket. Then, press and hold POWER to switch on the parent unit to establish connection with the baby unit. Perhaps the baby unit is not connected to the power. Insert the adapter plug into the baby unit and insert the adapter in a wall socket. Then, slide the ON/OFF switch to ON to switch on the baby unit and to establish connection with the parent unit.
Why doesn't my parent unit charge while connected to AC power?	Make sure the power is not controlled by an electronically controlled wall switch. The battery may be degraded through extended use or be defective. See Warranty for repair/replacement.
Why is my screen in black and white?	The screen is in black and white during night-time or in a dark room when the night vision feature is activated. This is normal.
Why do I get glare or blurry display on my screen when viewing my baby at night?	During night-time or in a dark room, the surroundings and other interfering factors, like lighting, objects, colors and backgrounds may affect the image quality on your parent unit screen. Adjust the baby unit angle or place the baby unit at a higher level to prevent glare and a blurry display.
Why does the baby monitor produce a feedback noise?	The parent unit and baby units may be too close to each other. <ul style="list-style-type: none">• Move the parent unit away from the baby unit until the noise stops; OR• Turn down the volume of your parent unit.
Why does the parent unit beep?	The baby units may be out of range. Move the parent unit closer to the baby units (but not less than 1m).
Why does the parent unit react too quickly to other sounds?	The parent unit also picks up other sounds than those of your baby. Adjust the sound sensitivity level to a lower level or lower the parent unit speaker volume.
Why don't I hear a sound/Why can't I hear my baby cry?	The parent unit speaker volume may be too low. See Adjust parent unit speaker volume to increase the volume.
Why can't I establish a connection? Why is the connection lost every now and then? Why are there sound interruptions?	The baby units may be out of range. Move the parent unit closer to the baby units (but not less than 1m). Other electronic products and wireless products may cause interference with your baby monitor. Try installing your baby monitor as far away from these devices as possible.

THE RBRC SEAL

The RBRC seal on the Li-ion battery indicates that VTech Communications, Inc. is voluntarily participating in an industry program to collect and recycle these batteries at the end of their useful lives, when taken out of service within the United States and Canada.

The program provides a convenient alternative to placing used Li-ion batteries into the trash or municipal waste, which may be illegal in your area.

The RBRC Seal and 1 (800) 8 BATTERY® are registered trademarks of Cal2ecycle, Inc.

FCC AND IC REGULATIONS

FCC Part 15
This equipment has been tested and found to comply with the requirements for a Class B digital device under Part 15 of the Federal Communications Commission (FCC) rules. These requirements are intended to provide reasonable protection against harmful interference in a residential installation. This equipment generates, uses and can radiate radio frequency energy and, if not installed and used in accordance with the instructions, may cause harmful interference to radio communications. However, there is no guarantee that interference will not occur in a particular installation. If this equipment does cause harmful interference to radio or television reception, which can be determined by turning the equipment off and on, the user is encouraged to try to correct the interference by one or more of the following measures:

- Reorient or relocate the receiving antenna.
- Increase the separation between the equipment and receiver.
- Connect the equipment into an outlet on a circuit different from that to which the receiver is connected.
- Consult the dealer or an experienced radio/TV technician for help.

WARNINGS: Changes or modifications to this equipment not expressly approved by the party responsible for compliance could void the user's authority to operate the equipment.

This device complies with Part 15 of the FCC rules. Operation is subject to the following two conditions: (1) this device may not cause harmful interference, and (2) this device must accept any interference received, including interference that may cause undesired operation. To ensure safety of users, the FCC has established criteria for the amount of radio frequency energy that can be safely absorbed by a user or bystander according to the intended usage of the product. This product has been tested and found to comply with the FCC criteria. The baby unit shall be installed and used such that parts of all persons' body are maintained at a distance of approximately 8 in (20 cm) or more. The transmitter and antenna of the parent unit shall be held at least 1 in (2.5 cm) from your face.

This Class B digital apparatus complies with Canadian requirement: CAN ICES-3 (B)/NMB-3(B)

Industry Canada
This device contains licence-exempt transmitter(s)/receiver(s) that comply with Innovation, Science and Economic Development Canada's licence-exempt RSS(s). Operation is subject to the following two conditions: (1) This device may not cause interference. (2) This device must accept any interference, including interference that may cause undesired operation of the device. The term "IC" before the certification/registration number only signifies that the Industry Canada technical specifications were met. This product meets the applicable Innovation, Science and Economic Development Canada technical specifications.

RF radiation exposure statement
The product complies with FCC RF radiation exposure limits set forth for an uncontrolled environment. The baby unit should be installed and operated with a minimum distance of 8 in (20 cm) between the baby unit and all persons' body. Use of other accessories may not ensure compliance with FCC RF exposure guidelines. This equipment complies also with Industry Canada RSS-102 with respect to Canada's Health Code 6 for Exposure of Humans to RF Fields.

CALIFORNIA ENERGY COMMISSION BATTERY CHARGING TESTING MODE

This baby monitor meets the California Energy Commission (CEC) regulations for energy consumption. Your baby monitor is set up to comply with the energy conservation standards right out of the box. Follow the instructions to install and charge the battery. The CEC battery charging testing mode is activated while charging. Even if the parent unit is paired to baby units, the CEC battery charging testing mode is activated while it is powered off and charging.

DISCLAIMER AND LIMITATION OF LIABILITY

VTech Communications, Inc. and its suppliers assume no responsibility for any damage or loss resulting from the use of this user's manual. VTech Communications, Inc. and its suppliers assume no responsibility for any loss or claims by third parties that may arise through the use of this product.
Company: VTech Communications, Inc.
Address: 9020 SW Watlington Square Road • Ste 555 Tigard, OR 97223, United States
Phone: 1 (800) 595-9511 in the U.S. or 1 (800) 267-7377 in Canada

FOR CETL COMPLIANCE ONLY

Mesures de sécurité importantes
La plaque signalétique appliquée est située au bas du socle de l'appareil.
Lorsque vous utilisez votre appareil, vous devriez toujours suivre certaines mesures de précaution de base afin de réduire les risques d'incendie, d'électrocution et de blessures corporelles, dont ceux-ci suivent :

1. Observez toutes les instructions et mises en garde inscrites sur l'appareil.
2. L'installation par un adulte est requise.
3. **MISE EN GARDE:** N'installez pas l'unité du bébé à une hauteur supérieure à 2 mètres.
4. Ce produit ne remplace pas la surveillance adulte du nourrisson. La supervision du nourrisson est la responsabilité du parent ou de la personne qui s'occupe de l'enfant. Ce produit pourrait cesser de fonctionner et, par conséquent, vous ne devriez pas présumer qu'il continuera de fonctionner correctement pendant une période de temps donnée. De plus, il ne s'agit pas d'un instrument médical et ne devrait pas être utilisé comme tel. Ce produit est destiné à vous aider à superviser votre bébé.
5. N'utilisez pas cet appareil près de l'eau ni de toute autre source d'humidité, par exemple, près d'une baignoire, cuve à lessive, évier de cuisine, dans un sous-sol humide ni près d'une piscine, dans un soussol humide ou une douche.
6. **MISE EN GARDE:** N'utilisez que la pile fournie. Il peut y avoir un risque d'explosion si un mauvais type de pile est utilisé pour le dispositif appasant. La pile ne peut pas être soumise à des températures extrêmes et/ou à une pression atmosphérique ou une haute altitude pendant son utilisation, son entreposage ou son transport. Le fait de jeter la pile dans un feu ou dans un four chaud, ou d'exposer ou de couper mécaniquement la pile peut entraîner une explosion. Le fait de laisser la pile dans un environnement à température extrêmement élevée peut entraîner une explosion ou une fuite de liquide ou de gaz inflammable. Une pile soumise à une pression d'air extrême bas peut provoquer une explosion ou une fuite de liquide ou de gaz inflammable. Mettre au rebut la pile usagée conformément aux informations figurant dans la section **Le sceau RBRC**.
7. N'utilisez que les adaptateurs inclus avec ce produit. L'utilisation d'un adaptateur dont la polarité ou la tension serait inadéquate risque d'endommager sérieusement le produit et mettre votre sécurité en danger.

Mises en garde

1. Utilisez et entreposez le produit à une température entre 0 °C (32 °F) et 40 °C (104 °F).
2. N'exposez pas l'appareil à des froids ou des chaleurs extrêmes, ainsi qu'à la lumière directe du soleil. Ne l'installez pas près d'une source de chauffage.
3. Le bloc-piles ne doit pas être exposé à la chaleur excessive telle que la lumière du soleil ou au feu.

CONSERVEZ CES INSTRUCTIONS

4. **Avertissement - Risque de strangulation** - Les enfants se sont **ÉTRANGLES** dans des cordons. Gardez ce cordon hors de portée des enfants (à plus de 0,9 m). N'enlevez pas cette étiquette.
5. Ne jamais placer le moniteur à l'intérieur du berceau ou du parc de bébé. Ne jamais couvrir le moniteur ou l'unité (s) portative avec un article ou une serviette ou une couverture.
6. **Autres équipements électroniques peuvent produire des interférences sur votre moniteur vidéo et audio.** Testez régulièrement votre moniteur vidéo ou audio à l'écart des appareils électroniques tels que des routeurs sans fil, radios, téléphones cellulaires, interphones, monteurs, téléphones, ordinateurs (ont pas été conçus pour supporter les interférences sans fil).
7. **Stimulateurs cardiaques implantés dans l'organisme**
Les stimulateurs cardiaques (ne s'applique qu'aux dispositifs sans fil) :
 - L'organisme Wireless Technology Research, LLC (WTR), une firme de recherche indépendante, a mené une évaluation pluridisciplinaire des interférences entre les téléphones sans fil portatifs et les stimulateurs cardiaques implantés dans l'organisme. Appuyez sur l'Administration des aliments et drogues (FDA) des États-Unis, la firme WTR recommande aux médecins:
 - **AVIS AUX DÉTENTEURS DE STIMULATEURS CARDIAQUES**
 - Vous devriez maintenir les dispositifs sans fil à au moins six pouces du simulateur cardiaque.
 - Ils ne doivent PAS passer le téléphone sans fil directement sur le stimulateur cardiaque, tel que dans une poche de chemise, lorsque celui-ci est en marche.
 - L'étude effectuée par l'organisme WRS n'a pas identifié de risque pour les détenteurs de stimulateurs cardiaques causés par les gens qui utilisent des dispositifs sans fil à proximité de ceux-ci.
8. **Champs électromagnétiques (EMF)**
Ce produit de VTech est conforme à toutes les normes se rapportant aux champs électromagnétiques (EMF) standard. Si vous utilisez votre appareil correctement en suivant les instructions de ce guide, son utilisation sera sécuritaire pendant de nombreuses années, selon les meilleures évidences scientifiques dont nous disposons aujourd'hui.

LIMITED WARRANTY

What does this limited warranty cover?

The manufacturer of this VTech Product warrants to the holder of a valid proof of purchase ("Consumer" or "you") that the Product and all accessories provided in the sales package ("Product") are free from defects in material and workmanship, pursuant to the following terms and conditions, when installed and used normally and in accordance with the Product operating instructions. If we repair the Product, we may use new or refurbished replacement parts. If we choose to replace the Product, we may replace it with a new or refurbished Product of the same or similar design. We will retain defective parts, modules, or equipment. Repair or replacement of the Product, at VTech's option, is your exclusive remedy. VTech will return the repaired or replacement Products to you in working condition. You should expect the repair or replacement to take approximately 30 days.

What will VTech do if the Product is not free from defects in materials and workmanship during the limited warranty period ("Materially Defective Product")?

During the limited warranty period, VTech's authorized service representative will repair or replace at VTech's option, without charge, a Materially Defective Product. If we repair the Product, we may use new or refurbished replacement parts. If we choose to replace the Product, we may replace it with a new or refurbished Product of the same or similar design. We will retain defective parts, modules, or equipment. Repair or replacement of the Product, at VTech's option, is your exclusive remedy. VTech will return the repaired or replacement Products to you in working condition. You should expect the repair or replacement to take approximately 30 days.

How long is the limited warranty period?

The limited warranty period for the Product extends for ONE (1) YEAR from the date of purchase. If VTech repairs or replaces a Materially Defective Product under the terms of this limited warranty, this limited warranty also applies to the repaired or replacement Product for a period of either (a) 90 days from the date the repaired or replacement Product is shipped to you or (b) the time remaining on the original one-year warranty, whichever is longer.

What is not covered by this limited warranty?

This limited warranty does not cover:

1. Product that has been subjected to misuse, accident, shipping or other physical damage, improper installation, abnormal operation or handling, neglect, inundation, fire, water or other liquid intrusion, or
2. Product that has been damaged due to repair, alteration or modification by anyone other than an authorized service representative of VTech; or
3. Product to the extent that the problem experienced is caused by signal conditions, network reliability, or cable or antenna systems; or
4. Product to the extent that the problem is caused by use with non-VTech accessories; or
5. Product whose warranty/quality stickers, produced by serial number plates or electronic serial numbers have been removed, altered or rendered illegible; or
6. Product purchased, used, serviced, or shipped for repair from outside the United States of America or Canada, or used for commercial or institutional purposes (including but not limited to Products used for rental purposes); or
7. Product returned without a valid proof of purchase (see item 2 below); or
8. Charges for installation or set up, adjustment of customer controls, and installation or repair of systems outside the unit.

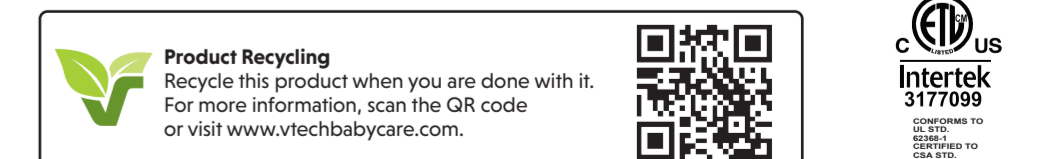

Specifications are subject to change without notice.
© 2024 VTech Communications, Inc. All rights reserved.
10/24_VM924-X_US_GSG_V2

