

Go to www.vtechphones.com to register your product for enhanced warranty support and the latest VTech product news.

VM345
VM345-15
VM345-19
VM345-2

Safe & Sound®
Full Color Video Monitor



vtech®

User's manual

Congratulations

on purchasing your new VTech product. Before using this product, please read **Important safety instructions**.

This manual has all the feature operations and troubleshooting necessary to install and operate your new VTech product. Please review this manual thoroughly to ensure proper installation and operation of this innovative and feature rich VTech product.

For support, shopping, and everything new at VTech, visit our website at www.vtechphones.com.

What's in the box

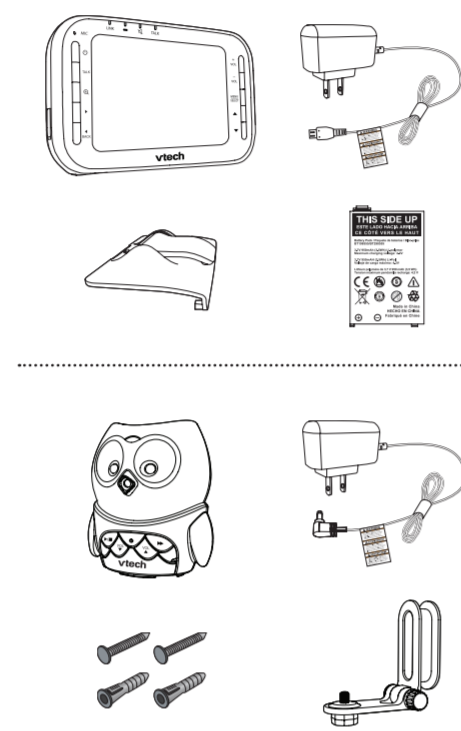

1 set for VM345/VM345-15/VM345-19
2 sets for VM345-2

Install the battery

The parent unit runs on rechargeable battery or AC power. To continuously monitor your baby, make sure you use both battery and AC power at the same time. With the battery alone, the parent unit can cordlessly run for a short time only.

NOTES

- Use only the battery supplied with this product.
- The power adapters are intended to be correctly oriented in a vertical or floor mount position. The prongs are not designed to hold the plug in place if they are plugged into a ceiling, under-the-table or cabinet outlet.
- Make sure the parent unit, the baby unit and the power adapter cords are out of reach of children.

Install the battery as shown below.

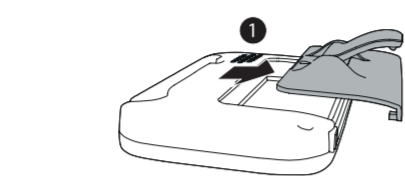

NOTE

- Press down on the large tab of the battery compartment cover to pull it out.

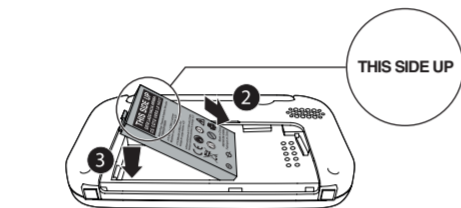

NOTE

- Make sure the label **THIS SIDE UP** is facing up while inserting the battery.

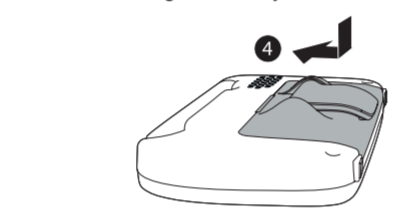

Replace the battery

To replace the battery, press down on the large tab of the battery compartment cover and pull it out, then follow the steps above to install the battery.

Connect and charge the battery

NOTES

- Use only the power adapters supplied with this product.
- Make sure the electrical outlets are not controlled by wall switches.
- The power adapters are intended to be correctly oriented in a vertical or floor mount position. The prongs are not designed to hold the plug in place if they are plugged into a ceiling, under-the-table or cabinet outlet.
- Make sure the parent unit, the baby unit and the power adapter cords are out of reach of children.

Connect the baby monitor

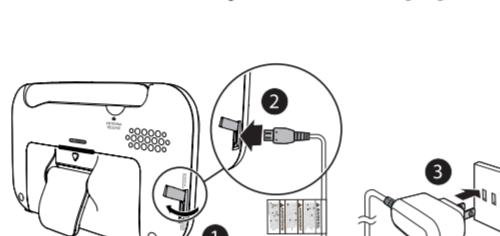
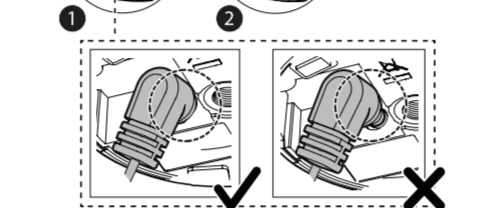
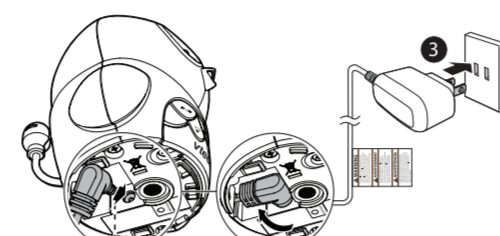

Charge the parent unit battery

When you have connected the parent unit and installed its battery for the first time or after power outage, the parent unit powers on automatically. The battery icon indicates the battery status (see the following table).

NOTES

- The parent unit battery is fully charged after 3 hours of continuous charging.
- It takes longer to charge the battery when the parent unit is turned on. To shorten the charging time, turn the parent unit off while charging.
- The standby time varies depending on the sensitivity level you set, your actual use and the age of the battery.

Battery indicators	Battery status	Action
The battery icon is off and displays.	No battery is installed but operates using AC power, or the battery has been installed incorrectly.	Install the parent unit battery. Charge without interruption (at least 30 minutes).
The screen displays Battery low at Parent Unit and . The lights flashes.	The battery has very little charge and may be used for only a short time.	Charge without interruption (about 30 minutes).
The battery icon becomes solid .	The battery is fully charged.	To keep the battery charged, connect it to AC power when not in use.

Before use

NOTE

- This baby monitor is intended as an aid. It is not a substitute for proper adult supervision, and should not be used as such.

Test your baby monitor

You may test the baby monitor before initial use, and at regular times thereafter.

CAUTION

- For hearing protection, make sure the parent unit is more than 1 meter (3 feet) away from the baby unit. If you hear any high-pitched noise, move the parent unit further until the noise stops. You can also press **VOL** on the parent unit to lower or mute the noise.

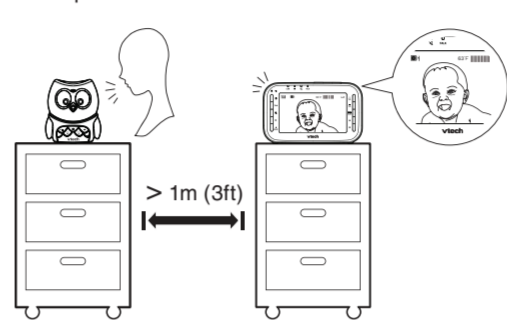

- Make sure your baby units and parent unit are on.
- The parent unit displays images from the baby unit.
 - Speak towards the baby unit microphone. You will hear the sound at the parent unit.
- If you have more than one baby unit, press **VIEW** on the top of your parent unit. The screen switches to other baby units. Then, repeat step 2.

NOTE

- When the parent unit displays and then **No link to CAM #** (# represents the selected baby unit number), and the **LINK** LED light flashes, move the parent unit closer to the baby unit (observe the minimum distance of 1 meter/ 3 feet). You can also check if the baby monitor is connected to a live power socket and switched on.

TIP

- Increase the parent unit speaker volume if you cannot hear the sounds transmitted from the baby unit.

Positioning the baby monitor

CAUTION

- Keep the baby units out of the reach of your baby. Never place or mount the baby units inside the baby's crib or playpen.

NOTE

- To avoid interference from other electronic devices, place your baby monitor far away from devices such as wireless routers, microwaves, cell phones and computers.

- Place the baby units more than 1 meter (3 feet) away from your baby.

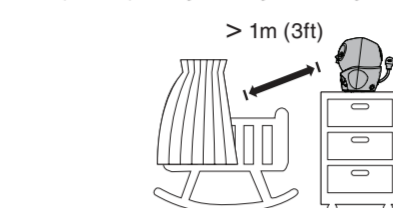

- Adjust the angle of the baby unit camera to aim at your baby.

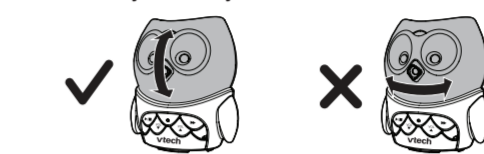

- Place the parent unit more than 1 meter (3 feet) away from the baby units.

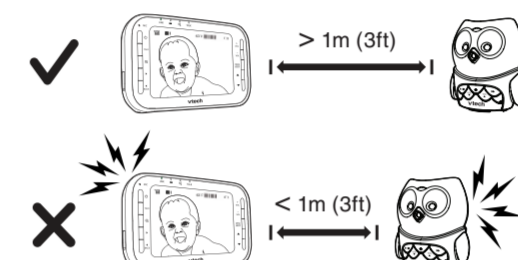

CAUTION

- The default volume of your parent unit is level 4. If you experience high-pitched screaming noise from your baby monitor while positioning:
 - Make sure your baby units and parent unit are more than 1 meter (3 feet) apart, OR
 - Turn down the volume of your parent unit.

Operating range

The operating range of the baby monitor is up to 300 meters (1,000 feet) outdoors or 50 meters (160 feet) indoors. The actual operating range may vary depending on the environmental conditions and other interferences such as walls, doors and other obstructions.

Overview

Baby unit overview

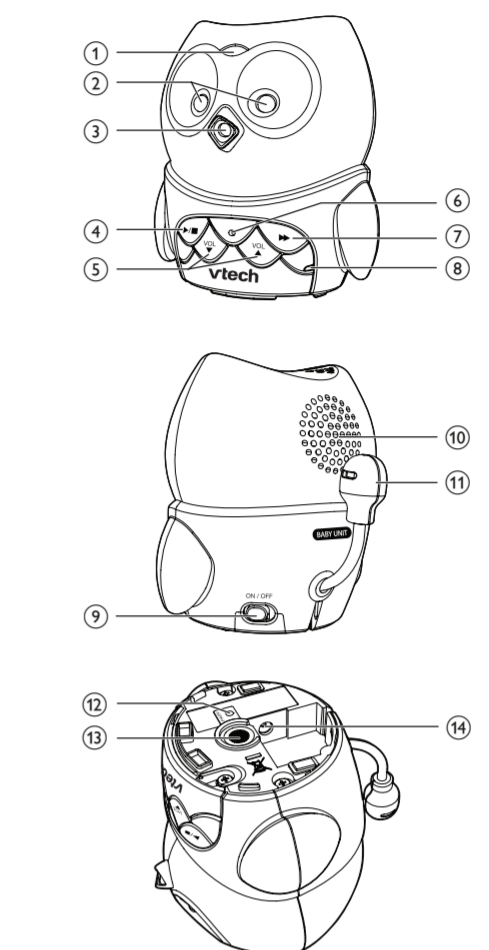

1	Light sensor
2	Infrared LEDs
3	Camera
4	▶/■ Play/Stop <ul style="list-style-type: none"> Press to play or stop lullaby on the baby unit.
5	▼/VOL/▲ <ul style="list-style-type: none"> Press to adjust the baby unit speaker volume. It determines the lullaby volume and talkback volume transmitted from the parent unit.
6	Microphone
7	▶ Skip <ul style="list-style-type: none"> Press to play the next lullaby.
8	ON/OFF light <ul style="list-style-type: none"> On when the baby unit is turned on and is paired to the parent unit. Flashes when the baby unit is not being viewed, or when the link to the parent unit is lost.
9	ON/OFF switch <ul style="list-style-type: none"> Slide to turn on or off the baby unit.
10	Speaker
11	Temperature sensor
12	PAIR <ul style="list-style-type: none"> Your baby units and parent unit provided are already paired. Press and hold on accessory baby units (VM315/VM315-15/VM315-19, purchased separately) to pair to the parent unit.
13	Threaded socket <ul style="list-style-type: none"> For wall mount installation use.
14	Power jack

Parent unit overview

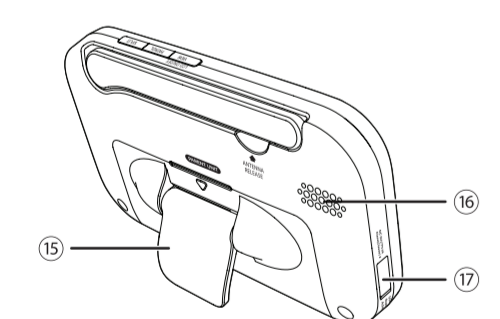
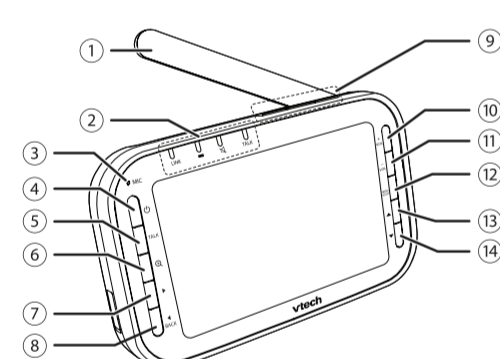

1	Antenna
2	LED lights <ul style="list-style-type: none"> Indicate the different statuses of the parent unit. For details, refer to Parent unit lights.
3	Microphone
4	On/off <ul style="list-style-type: none"> Press and hold to power on. Press and hold again to power off.
5	TALK <ul style="list-style-type: none"> Press and hold to talk to the selected baby unit in SINGLE-CAM or PATROL mode.
6	Zoom <ul style="list-style-type: none"> Press to zoom in or out while viewing image in SINGLE-CAM or PATROL mode.

7	▶ <ul style="list-style-type: none"> While in a menu, press to choose an item. While viewing zoomed image, press and hold to move the zoomed image rightward. While in SPLIT-VIEW mode, press to move the selection box rightward.
8	◀ BACK <ul style="list-style-type: none"> While in a menu, press to return to the main menu or idle screen. While viewing zoomed image, press and hold to move the zoomed image leftward. While in SPLIT-VIEW mode, press to move the selection box leftward.
9	VIEW / LCD ON/OFF <ul style="list-style-type: none"> Press and hold to turn off the parent unit screen. Press to view the image of the next baby unit in SINGLE-CAM or PATROL mode. <p>PATROL</p> <ul style="list-style-type: none"> Press to turn on or off the PATROL mode. <p>SPLIT</p> <ul style="list-style-type: none"> Press to turn on or off the SPLIT-VIEW mode.
10	+VOL <ul style="list-style-type: none"> Press to increase the parent unit speaker volume.
11	-VOL <ul style="list-style-type: none"> Press to decrease the parent unit speaker volume.
12	MENU/SELECT <ul style="list-style-type: none"> Press to enter the menu. While in a menu, press to choose an item, or save a setting.
13	▲ <ul style="list-style-type: none"> While in a menu, press to scroll up. While viewing zoomed image, press and hold to move the zoomed image upward. While in SPLIT-VIEW mode, press to move the selection box upward.

14	▼ <ul style="list-style-type: none"> While in a menu, press to scroll down. While viewing zoomed image, press and hold to move the zoomed image downward. While in SPLIT-VIEW mode, press to move the selection box downward.
15	Stand
16	Speaker
17	Power jack

Parent unit lights

LINK	On when the parent unit is linked to the baby unit. Flashes when the link to any baby unit being viewed is lost.
	On when the parent unit is connected to AC power, or the battery is charging. Flashes when the parent unit battery is low and needs charging. Off when the parent unit is disconnected from AC power.
TALK	On when the parent unit is talking to the baby unit.

Parent unit display icons

	Connection status <ul style="list-style-type: none"> displays when strong signal strength is detected between the baby unit and the parent unit. or displays when moderate or low signal strength is detected between the baby unit and the parent unit. displays when the link between the baby unit and the parent unit is lost.
	Lullaby <ul style="list-style-type: none"> Displays when the baby unit being viewed is playing lullaby.

	Current view status <ul style="list-style-type: none"> Displays the number of the baby unit that is being viewed when in SINGLE-CAM and PATROL mode. Displays the number of the highlighted baby unit when in SPLIT-VIEW mode.
	Patrol mode <ul style="list-style-type: none"> Displays when the parent unit is in PATROL mode.
	Split-view mode <ul style="list-style-type: none"> Displays when the parent unit is in SPLIT-VIEW mode.
	Night vision <ul style="list-style-type: none"> Displays when the baby unit being viewed has activated the night vision feature.
	Zoom <ul style="list-style-type: none"> Displays when the baby unit camera has zoomed in.
	Temperature alert tone <ul style="list-style-type: none"> Displays when the temperature alert tone is set on.
	Real-time temperature <ul style="list-style-type: none"> Displays the real-time temperature detected by the baby unit in Fahrenheit (°F) or Celsius (°C) (e.g. 57 °F or 14 °C).
	Mute alert <ul style="list-style-type: none"> Displays when the parent unit speaker volume is set to off. Displays when SPLIT-VIEW mode is turned on.
	9-level sound indicator <ul style="list-style-type: none"> (1 to 3 bars) indicates low sound level detected by the baby unit. (4 to 6 bars) indicates moderate sound level detected by the baby unit. (7 to 9 bars) indicates high sound level detected by the baby unit (e.g. baby crying loudly).
	Speaker volume <ul style="list-style-type: none"> Displays the parent unit speaker volume level while adjusting.

	Battery status <ul style="list-style-type: none"> animates when the battery is charging. displays solid when the battery is fully charged. displays when the battery is low and needs charging.
	AC power without battery <ul style="list-style-type: none"> Displays when the parent unit is connected to AC power without the battery.

Parent unit main menu icons

	Language <ul style="list-style-type: none"> You can select a language (English, French or Spanish) to be used in all screen displays.
	Alert Tone <ul style="list-style-type: none"> You can set the parent unit to beep when <ul style="list-style-type: none"> the parent unit operates in low battery condition; the link between the parent unit and the baby unit is lost; or the baby unit detects sounds while in SPLIT-VIEW mode.
	Sensitivity <ul style="list-style-type: none"> With this feature, you can choose to hear sounds from the baby unit all the time, or to hear sounds that exceed a certain level. You can use the parent unit to adjust the microphone sensitivity of your baby unit. The higher the sensitivity level, the more sensitive the baby unit is in detecting sounds for transmitting to the parent unit.
	Temperature <ul style="list-style-type: none"> You can turn on the Temperature alert tone so that the parent unit beeps whenever the room temperature detected by the baby unit falls outside of the desired temperature range.
	Vibration <ul style="list-style-type: none"> You can turn on the vibration alert so that the parent unit vibrates when it receives Low battery tone, No link alert, Sound alert in split-view or Temperature alert tone after turning on the respective alert tones.

	Sound-activated Screen <ul style="list-style-type: none"> Automatically turns on the parent unit screen when a baby unit detects a sound after the screen is turned off. When no sound is detected, the screen is automatically off to save power.
	LCD <ul style="list-style-type: none"> You can change the brightness of the parent unit screen, or turn on the Dim Mode to save power.
	Rename <ul style="list-style-type: none"> You can choose a specific name for the baby unit from a pre-defined name list.
	Pair/Unpair <ul style="list-style-type: none"> The baby unit and parent unit provided are already paired. You can add or replace baby units (VM315/VM315-15/VM315-19, purchased separately) to your baby monitor system.

Parent unit display messages

	The selected baby unit is out of range or is turned off.
	The battery level of the parent unit is very low and needs to be recharged.
	The battery is empty and needs to be recharged.
	The sound level exceeds the threshold at CAM # in SPLIT-VIEW mode.
	The temperature detected by the baby unit is higher/lower than the desired temperature alert range.
	The parent unit is turning on.
	The parent unit is searching for baby units.

* # represents the selected baby unit number.

Using the baby monitor

Power on or off the baby unit

- Slide the **ON/OFF** switch on the baby units to **ON** to power on. The **ON/OFF** LED light turns on.
- Slide the **ON/OFF** switch on the baby units to **OFF** to power off. The **ON/OFF** LED light turns off.

Power on or off the parent unit

- Press and hold to power on the parent unit. The screen turns on.
- Press and hold again to power off the parent unit. The screen turns off.

Turn on or off the parent unit screen

You can turn on or off the parent unit screen without powering off the parent unit. You can still hear sound from the baby units.

- Press and hold **LCD ON/OFF** on the top of the parent unit to turn off the screen.
- Press any key on the parent unit to turn on the screen again.

Adjust the speaker volume

- For parent unit:**
- Press **+ /VOL/ -** on the parent unit at any time when viewing images.

NOTE

- When the parent unit speaker volume is set to zero, appears on the screen and the light turns on.

For baby unit:

- The baby unit speaker volume determines the lullaby volume and talkback volume transmitted from parent unit.
- Press **▼ /VOL/ ▲** on the baby unit to adjust the speaker volume.

Play lullaby on the baby unit

You can play lullaby on the baby unit to comfort your baby.

- Press **▶/■** on the baby unit to play lullaby. It starts playing lullaby for 10 minutes.
- Press **▶▶** on the baby unit to switch to the other lullabies.
- Press **▶/■** again to stop the lullaby.

TIP

- When the lullaby stops, press **▶/■** again to replay.

Set the language

You can select a language (English, French or Spanish) to be used in all screen displays.

- Press **MENU** when the parent unit is idle.
- Press **▼** or **▲** to choose **Language**, then press **SELECT**.
- Press **▼** or **▲** to choose **English, Français** or **Español**, then press **SELECT** to confirm your selection.

Adjust LCD brightness

You can change the brightness of the parent unit screen from **Level 1** to **Level 5**. The LCD brightness is preset to **Level 3**.

- Press **MENU** when the parent unit is idle.
- Press **▼** or **▲** to choose **LCD**, then press **SELECT**.
- Press **SELECT** again to choose **Brightness**.
- Press **▼** or **▲** to choose the desired level of brightness, then press **SELECT** to confirm your selection.

Turn on or off the dim mode

The dim mode is preset to on to help you save the parent unit power. Whenever the parent unit has been left idle for 10 minutes while the screen is still on, the screen will be dimmed automatically to save power.

- Press **MENU** when the parent unit is idle.
- Press **▼** or **▲** to choose **LCD**, then press **SELECT**.
- Press **▼** or **▲** to choose **Dim Mode**, then press **SELECT**.
- Press **▼** or **▲** to choose **On** or **Off**, then press **SELECT** to confirm your selection.

NOTE

- While the screen is dimmed, any keypress or alert message will trigger the screen to return to the preset brightness level. After 10 minutes of idle, it will be dimmed again.

Adjust the sound sensitivity of the baby units

You can choose to hear sounds from the baby units all the time, or to hear sounds that exceed a certain level. You can use the parent unit to adjust the microphone sensitivity of your baby units from **Lowest** to **Highest**. The higher the sensitivity level, the more sensitive the baby unit is in detecting sounds for transmitting to the parent unit. The sound sensitivity level is preset to **Highest**.

Sound sensitivity table for reference

Sensitivity Level	Description
Highest	The parent unit speaker is constantly on, and you will hear all sounds (including background noises) from your baby's room.
High	The parent unit speaker turns on for soft babbling and louder sounds from your baby. It remains quiet when your baby sleeps soundly.
Medium	The parent unit speaker turns on for loud babbling and louder sounds from your baby. It remains quiet when your baby makes soft sounds.
Low	The parent unit speaker turns on for crying and louder sounds from your baby. It remains quiet when your baby makes soft sounds.
Lowest	The parent unit speaker turns on for loud crying or screaming sounds from your baby. It remains quiet when your baby makes soft sounds.

- Press **MENU** when the parent unit is idle.
- Press **▼** or **▲** to choose **Sensitivity**, then press **SELECT**.

