

Go to www.vtechphones.com to register your product for enhanced warranty support and the latest VTech product news.

VM3261
VM3261-2
Video Monitor



vtech

Quick start guide

WHAT'S IN THE BOX

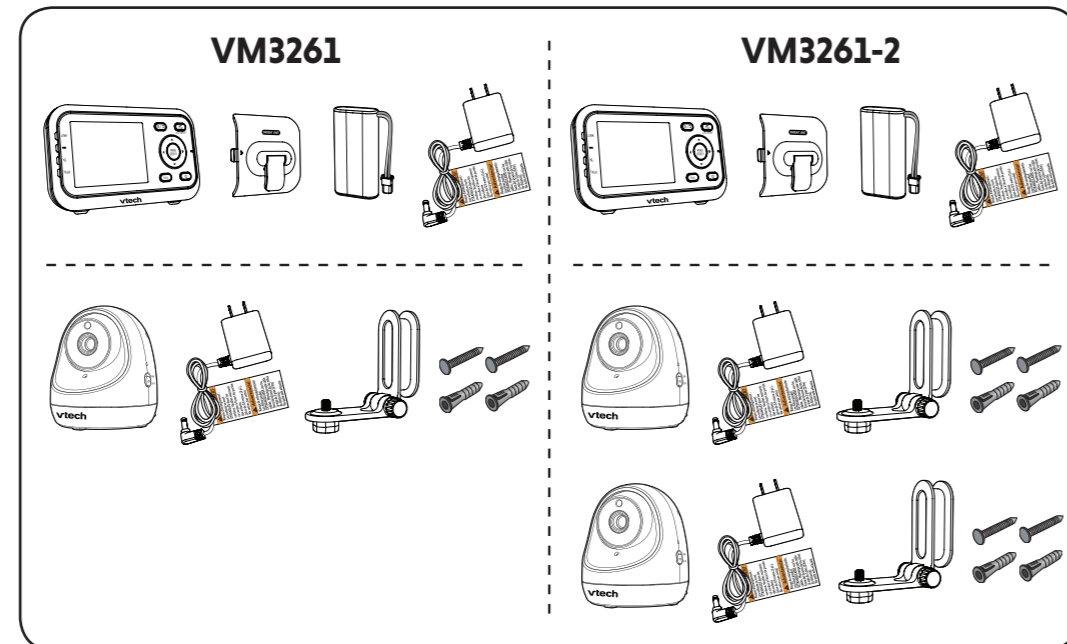

1 CONNECT THE BABY MONITOR

NOTES

- The rechargeable battery is pre-installed in your parent unit.
- Use only the power adapters supplied with this product.
- Make sure the baby monitor is not connected to the switch controlled electric outlet.
- Connect the power adapters in a vertical or floor mount position only. The adapters' prongs are not designed to hold the weight of baby monitor, so do not connect them to any ceiling, under-the-table, or cabinet outlets. Otherwise, the adapters may not properly connect to the outlets.
- Make sure the parent unit, the baby unit and the power adapter cords are out of reach of children.

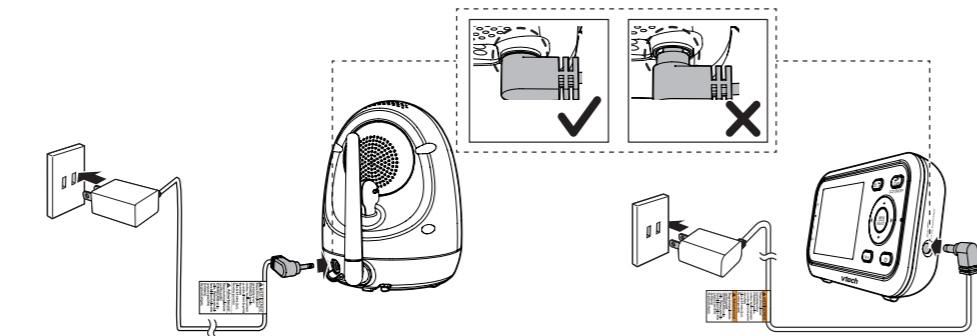

2 POWER ON THE BABY MONITOR

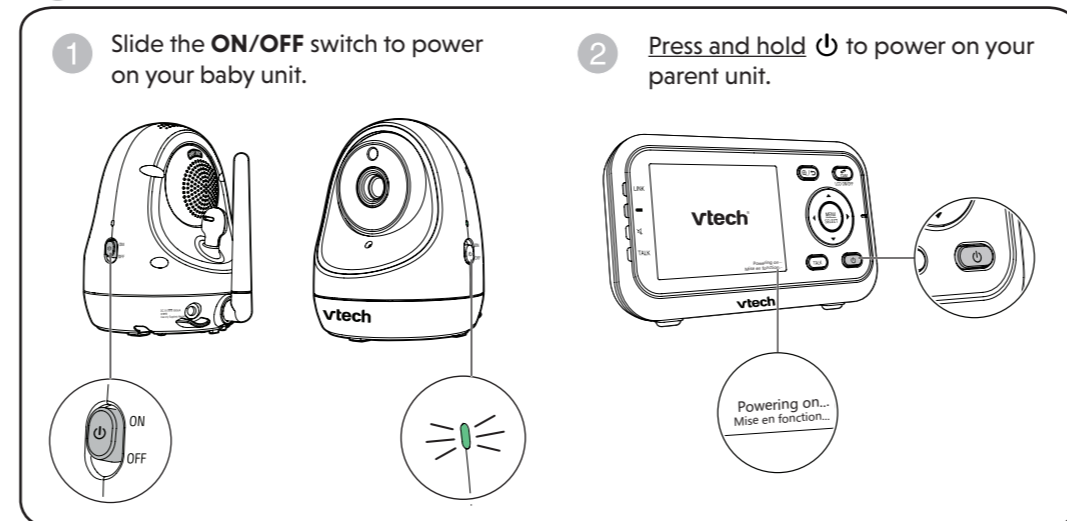

3 POSITIONING THE BABY MONITOR

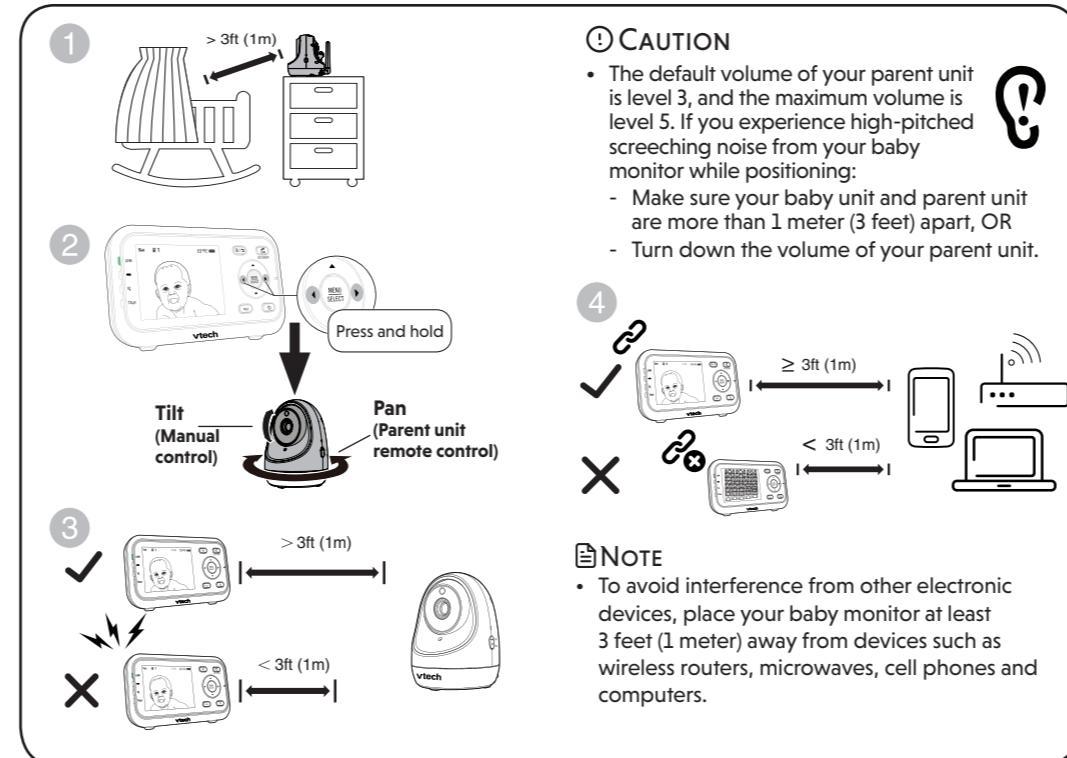

4 STATUS CHECK

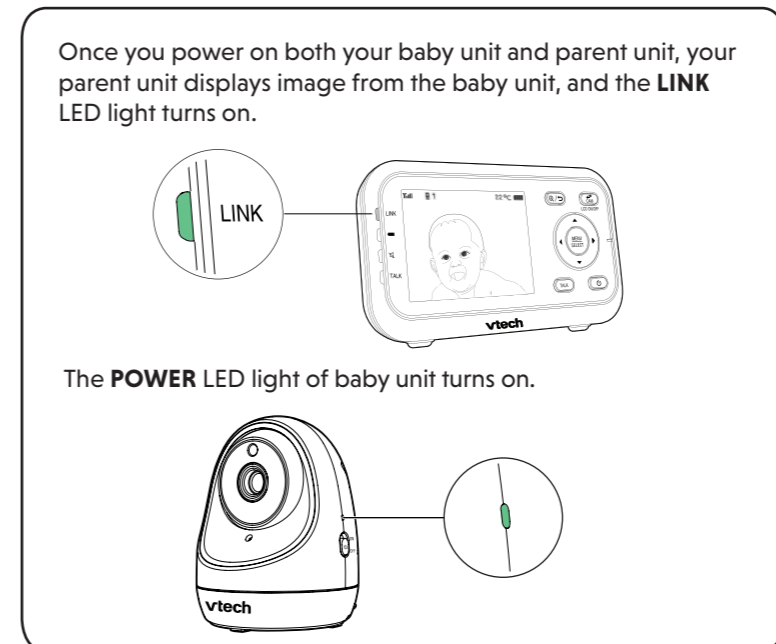

BASIC OPERATION - PARENT UNIT

Adjust speaker volume

Press **VOL+ / VOL-** to adjust your parent unit speaker volume. It determines the volume of sound transmitted from your baby units.



Turn off the screen

Press and hold **LCD ON/OFF** to switch off the screen. You can still hear sound from the selected baby unit.



TIP

- Press any keys on the parent unit to turn on the screen again.

Talk to your baby unit

Press and hold **TALK** and speak to your parent unit. Your voice is transmitted to the baby unit.

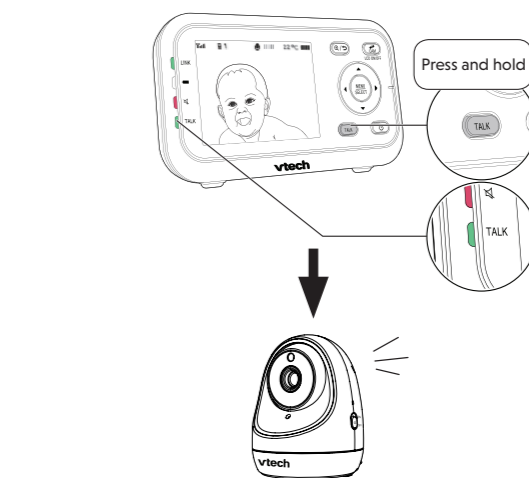

Pan, tilt, zoom

Press and hold **▲, ▼, ◀, ▶** to pan or tilt the image upward, downward, leftward or rightward.

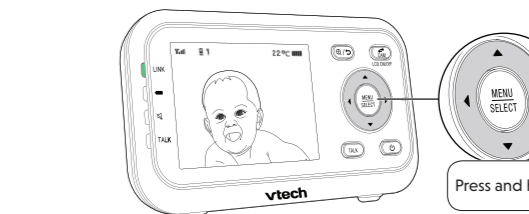

Press **Ⓜ** to zoom in or out.

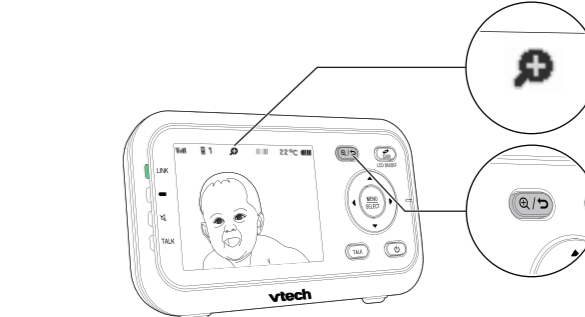

Use the menu

Press **MENU** to enter the menu, or save a setting. You can use the parent unit for advanced settings or operations, such as to play or stop the baby unit lullaby, or to adjust the baby unit sound sensitivity.

While in the menu:

- Press **◀** or **▶** to scroll among the menu options.
- Press **SELECT** or **▲** to enter the desired submenu.
- Press **▲** or **▼** to select an item.
- Press **SELECT** to confirm your selection.
- Press **⏪** or **▶** to exit the submenu.

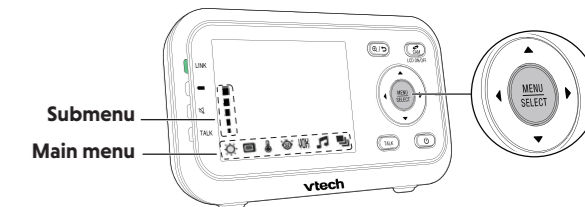

Turn off the parent unit

Press and hold **⏻** to power off your parent unit.

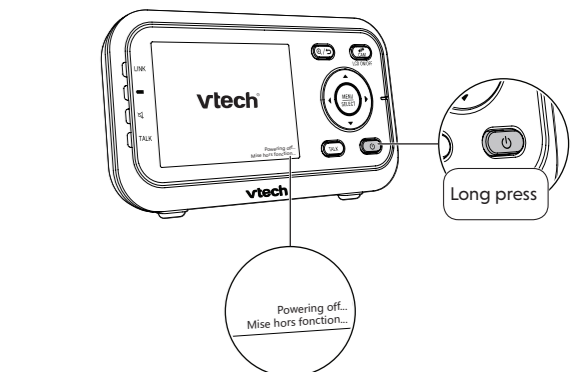

Document order number: 96-011938-070-100
© 2018 VTech Communications, Inc. All rights reserved.
Specifications are subject to change without notice.
11/18 VM3261-2_QSG_V8



BASIC OPERATION - BABY UNIT

Turn off the baby unit

Slide the **ON/OFF** switch to **OFF** to power off your baby unit.

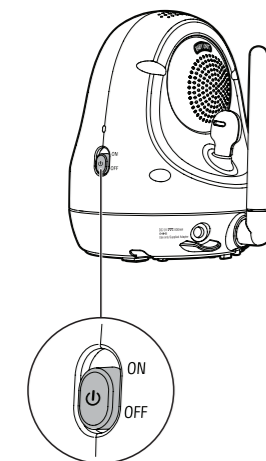

OVERVIEW - BABY UNIT

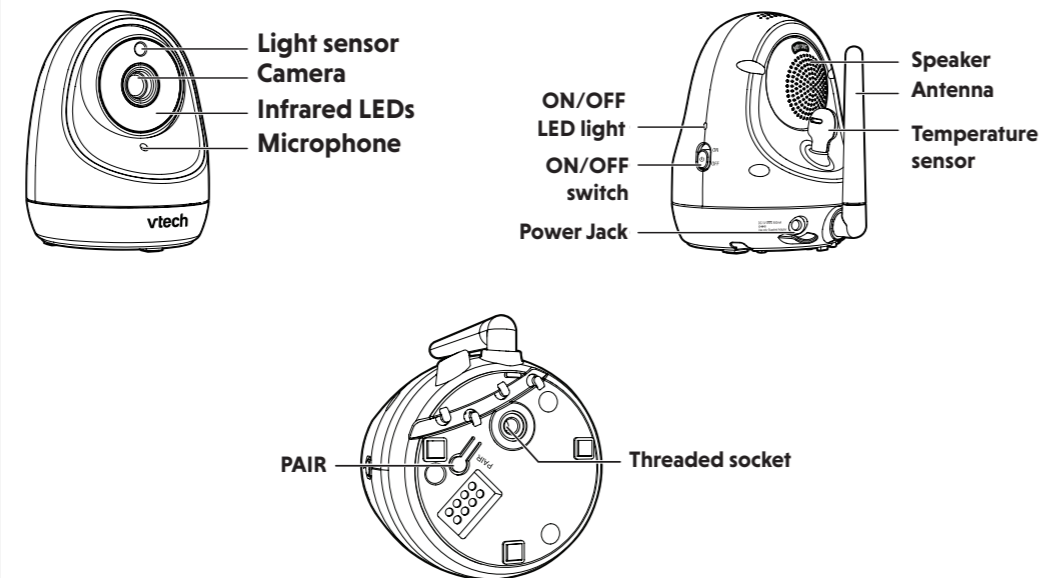

NIGHT VISION

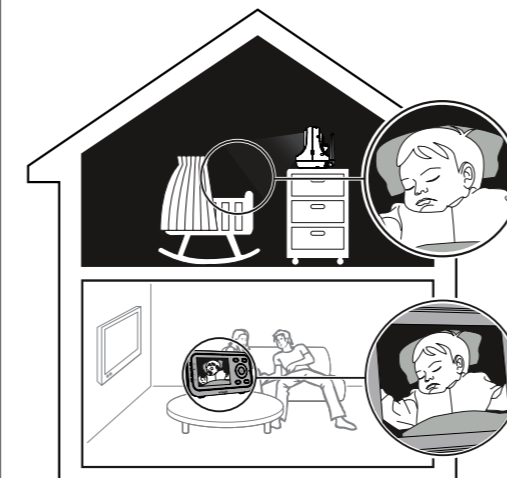

The baby unit has infrared LEDs that allow you to see your baby clearly at night or in a dark room. When the baby unit being viewed detects low light levels, the infrared LEDs are switched on automatically. The images from the baby unit are in black and white, and appears on the screen.

NOTES

- It is normal if you see a short white glare on your parent unit screen as the baby unit is adapting to the dark environment.
- When the infrared LEDs are on, the images are in black and white. This is normal.

TIP

- Depending on the surroundings and other interfering factors, like lightings, objects, colors and backgrounds, the display resolution may vary. Adjust the baby unit's angle or place the baby unit at a higher level to prevent glare and blurry display.

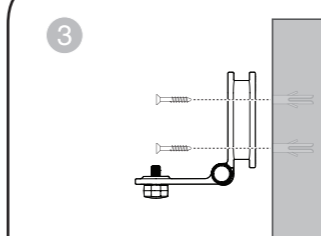

Align the wall mount bracket and screws with the holes in the wall as shown. Tighten the screw in the middle hole first, so that the wall mount bracket position is fixed. You can tighten the other screw in the top hole.

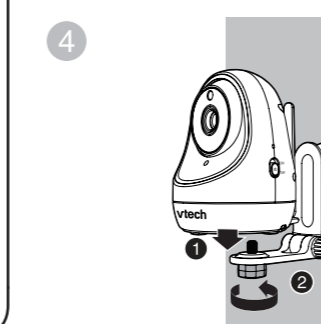

Place the baby unit on the wall mount bracket. Tighten the screw into the threaded socket at the bottom to secure the baby unit.

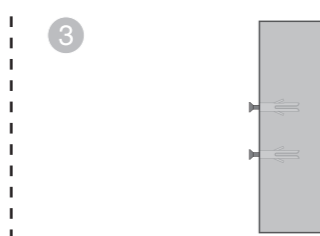

Insert the screws into the holes and tighten the screws until only 1/4 inch of the screws are exposed.

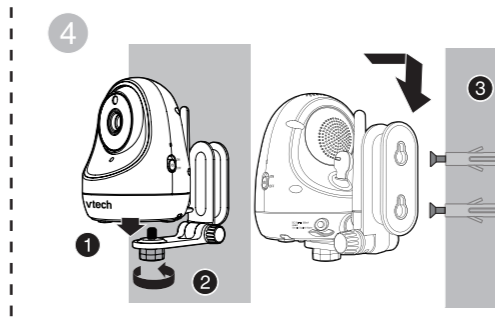

Place the baby unit on the wall mount bracket. Tighten the screw into the threaded socket at the bottom to secure the baby unit. Align the holes on the wall mount bracket with the screws on the wall, and slide the wall mount bracket down until it locks into place.

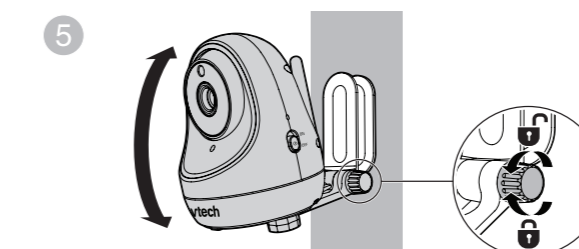

You can maximize your baby unit's viewing angles by tilting the wall mount bracket. Hold the baby unit, and then rotate the knob in anticlockwise direction. This will loosen the joint of the wall mount bracket. Tilt your baby unit up or down to adjust to your preferred angle. Then, rotate the knob in clockwise direction to tighten the joint and secure the angle.

FOR VM3261-2 ONLY

Status check - Two baby units

If you are viewing baby unit 1, the **POWER** LED light of baby unit 1 turns on. As baby unit 2 is not being viewed, its **POWER** LED light flashes.

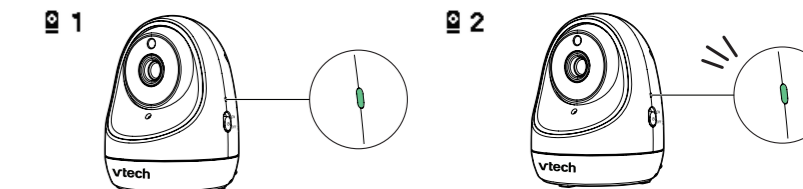

NOTE

- If you power on only one baby unit, your parent unit may display and the LINK LED light flashes. Press to switch to the baby unit you have powered on.

Change different views - Patrol

Press **MENU** when the parent unit is idle. Press or to choose , then press **SELECT** or . Press or to choose **ON**, then press **SELECT** to confirm your selection.

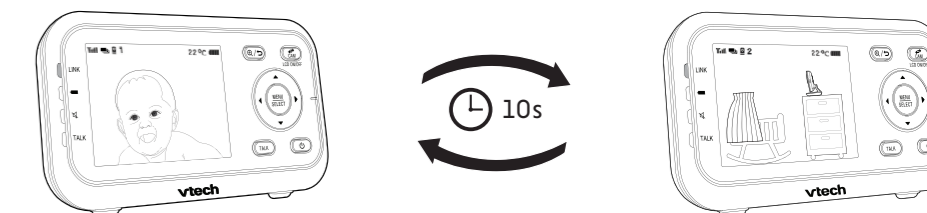

Change different views - Single-cam

Press to switch to another camera in **SINGLE-CAM** mode.

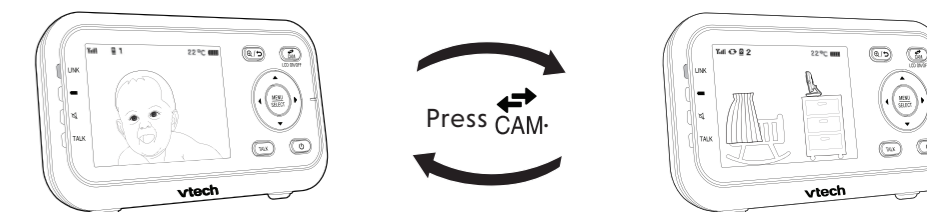

OVERVIEW - PARENT UNIT

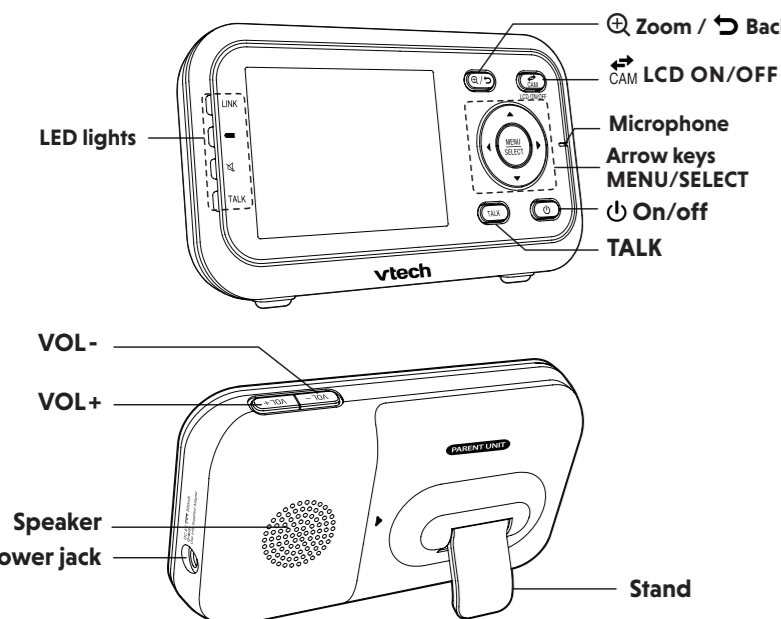

SOUND ACTIVATION

When the baby unit detects no sound, the parent unit screen stays off to save power. Once a sound is detected, the parent unit screen turns on automatically. It will then turn off again after 50 seconds of no sound detection.

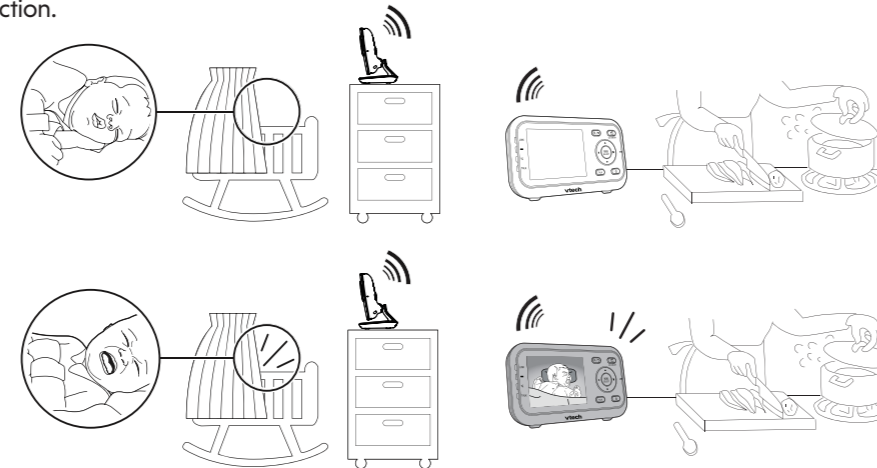

MOUNT THE BABY UNIT (OPTIONAL)

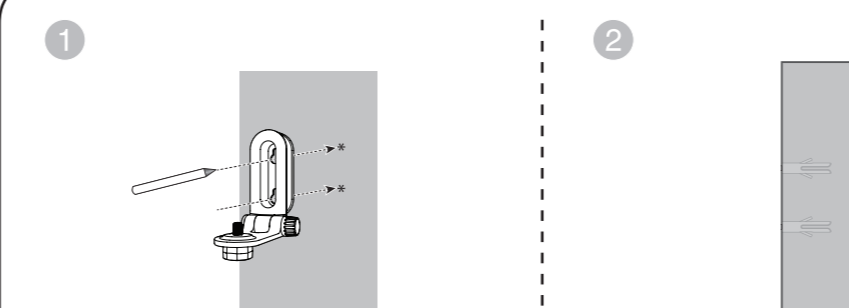

NOTE

- Check for reception strength and camera angle before drilling the holes.
- Use a pencil to mark two holes in parallel. Make sure they are the same distance apart as the wall mount holes on the baby unit.

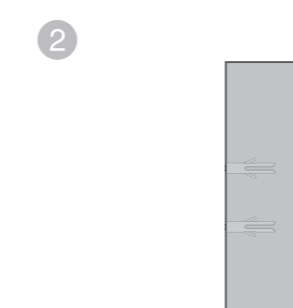

If you drill the holes into a stud, go to step 3.
-OR-
If you drill the holes into an object other than a stud, insert the wall anchors into the wall. Tap gently on the ends with a hammer until the wall anchors are flush with the wall.