

Go to [www.vtechphones.com](http://www.vtechphones.com) to register your product for enhanced warranty support and latest VTech product news.

VC9411  
VC9411-2  
VC9411-3  
VC9411-12  
VC9411-22

Full HD Camera with Alarm



**vtech**<sup>®</sup>  
Installation guide

## Congratulations

on purchasing your new VTech product. Before using this camera, please read **Important safety instructions**. For support, shopping, and everything new at VTech, visit our website at [www.vtechphones.com](http://www.vtechphones.com). In Canada, visit [www.vtechcanada.com](http://www.vtechcanada.com).

### Requirements

Make sure your system includes the following components, and they meet the minimum requirement.

Smartphones/tablets	<ul style="list-style-type: none"> <li>Android<sup>®</sup> or iOS devices with 3G/4G mobile communication.</li> <li>Android 4.4 or later; or iOS 8.0 or later.</li> </ul>
Network	Wi-Fi
Wi-Fi router	2.4GHz IEEE 802.11 b/g/n
Internet connection	1.5 Mbps @ 720p or 2.5 Mbps @1080p upload bandwidth per camera
Micro SD card (optional)	Support Class 4 or higher, with storage capacity up to 64GB

## WHAT'S IN THE BOX

Your HD camera package contains the following items. Save your sales receipt and original packaging in the event warranty service is necessary.

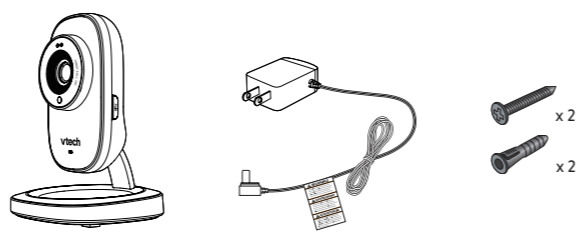

1 set for VC9411  
2 sets for VC9411-2

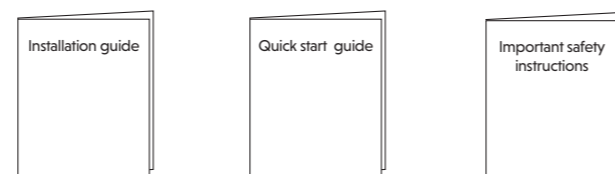

## OVERVIEW

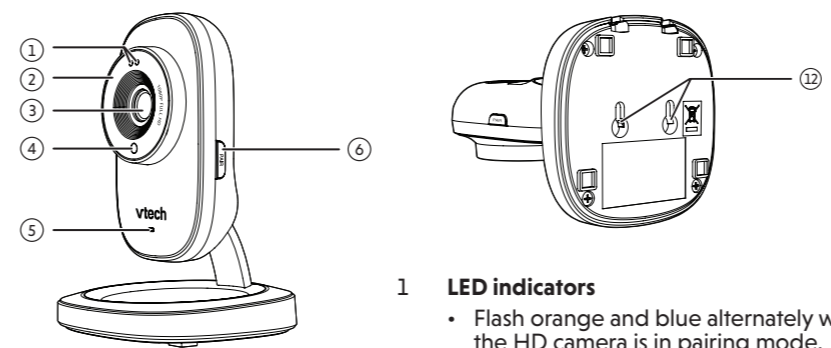

### 1 LED indicators

- Flash orange and blue alternately when the HD camera is in pairing mode.
- Orange is steady on when the HD camera is connecting to the Internet.
- Orange and blue are steady on when the HD camera is idle.
- Flash orange and blue slowly during video streaming.
- Flash orange and blue quickly and alternately when the HD camera is updating its firmware.

### TIP

- You can turn off the HD camera's LEDs if you find them too bright. Read the **LED online indication** section under **Camera settings** in the online app manual for instructions.

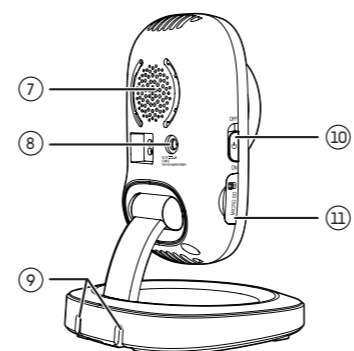

### 2 Infrared LEDs

- Allow you to see clearly in a dark surrounding.

### 3 Wide-angle camera lens

### 4 Light sensor

### 5 Microphone

### 6 PAIR button

- Press and hold for 3 seconds to enter pairing mode.
- Press and hold for 20 seconds to reset the camera settings to factory default.

### 7 Speaker

#### CAUTION

- For hearing protection, do not stand close to the HD camera when the camera's alarm goes off. The loud alarm may damage your hearing.

### 8 Power jack

### 9 Wall mount holes for upright mounting

### 10 ON/OFF switch

### 11 MICRO SD card slot

### 12 Wall mount holes for lateral mounting

## HOW THE SYSTEM WORKS

The Wi-Fi router (not included) provides Internet connectivity to your camera. It serves as a communicating channel between your camera and **MyVTech Cams** mobile app, allowing you to monitor and/or control your camera through the app wherever you are.

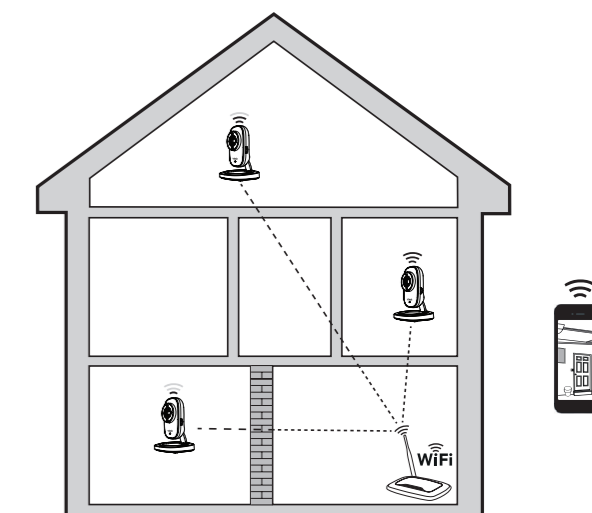

## PROTECT YOUR PRIVACY AND ONLINE SECURITY

VTech cares about your privacy and peace of mind. That's why we've put together a list of industry-recommended best practices to help keep your wireless connection private and your devices protected when online. We recommend you carefully review and consider complying with the following tips.

Ensure your wireless connection is secure.

- Before installing a device, ensure your router's wireless signal is encrypted by selecting the "WPA2-PSK with AES" setting in your router's wireless security menu.

Change default settings.

- Change your wireless router's default wireless network name (SSID) to something unique.
- Change default passwords to unique, strong passwords. A strong password:
  - Is at least 10 characters long.
  - Is complex.
  - Does not contain dictionary words or personal information.
  - Contains a mix of uppercase letters, lowercase letters, special characters and numbers.

Keep your devices up to date.

- Download security patches from manufacturers as soon as they become available. This will ensure you always have the latest security updates.
- If the feature is available, enable automatic updates for future releases.

Disable Universal Plug and Play (UPnP) on your router.

- UPnP enabled on a router can limit the effectiveness of your firewall by allowing other network devices to open inbound ports without any intervention or approval from you. A virus or other malware program could use this function to compromise security for the entire network.

For more information on wireless connections and protecting your data, please review the following resources from industry experts:

- Federal Communications Commission: Wireless Connections and Bluetooth Security Tips – [www.fcc.gov/consumers/guides/how-protect-yourself-online](http://www.fcc.gov/consumers/guides/how-protect-yourself-online).
- U.S. Department of Homeland Security: Before You Connect a New Computer to the Internet – [www.us-cert.gov/ncas/tips/ST15-003](http://www.us-cert.gov/ncas/tips/ST15-003).
- Federal Trade Commission: Using HD cameras Safely – <https://www.consumer.ftc.gov/articles/0382-using-ip-cameras-safely>.
- Wi-Fi Alliance: Discover Wi-Fi Security – <http://www.wi-fi.org/discover-wi-fi/security>.

## 1 CONNECT AND POWER ON THE CAMERA

### NOTES

- Use only the power adapter(s) supplied with this product.
- Make sure the HD camera is not connected to a switch controlled electric outlet.
- Connect the power adapter in a vertical or floor mount position only. The adapter's prongs are not designed to hold the weight of the HD camera, so do not connect it to any ceiling, under-the-table, or cabinet outlet. Otherwise, the adapter may not properly connect to the outlet.
- Make sure the HD camera and the power adapter cord are out of reach of children.
- To maintain compliance with the FCC's RF exposure guidelines, place the HD camera at least 20cm from nearby persons.

1. Connect the power adapter to the HD camera and a power supply.

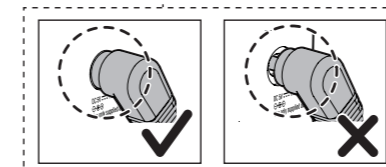
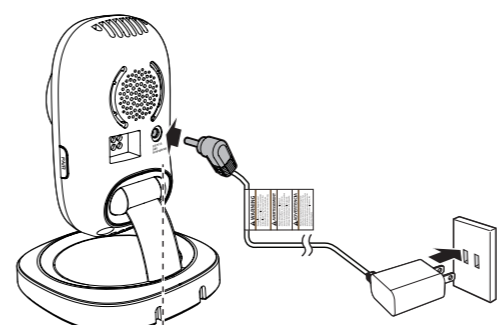

2. Slide the ON/OFF switch to ON to power on your HD camera.

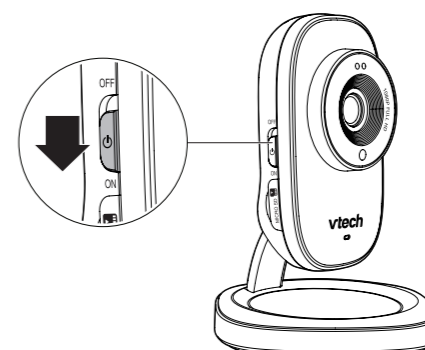

### NOTE

- To turn off the HD camera, slide the ON/OFF switch to OFF.

## 2 SET UP CAMERA

After you have connected the HD camera, refer to the Quick start guide included in your package to set up your camera.

HD camera setup:

- Install MyVTech Cams mobile app
- Create camera account
- Add camera

### Wi-Fi connection

#### NOTE

- Before you connect the HD camera, make sure you have Internet access and a Wi-Fi router (IEEE 802.11 b/g/n). Charges apply and service plan may vary for Internet access. Router is not included.

Document order number: 96-012370-020-100  
All rights reserved. 12/18 VC9411-X-IG\_V3.0  
© 2018 VTech Communications, Inc.  
Specifications are subject to change without notice.



App Store is a trademark of Apple Inc., registered in the U.S. and other countries.  
Google Play and the Google Play logo are trademarks of Google LLC.

Frequency	Camera unit: 2412 - 2462 MHz
Channels	11
Nominal effective range	Maximum power allowed by FCC and IC. Actual operating range may vary according to environmental conditions at the time of use.
Power requirement	Camera unit power adapter: Output: 5V DC 1500mA

## TECHNICAL SPECIFICATIONS

### 3 TEST THE LOCATION FOR CAMERA

Before you install your HD camera, you need to test which of your selected monitoring areas within the house have good Wi-Fi signal strength. You can use your mobile device's Wi-Fi signal strength indicator to assist in checking. Once you have identified the suitable location, you can install your HD camera. Adjust the distance between your HD camera and the Wi-Fi router if needed.

#### TIPS

- Depending on surroundings and obstructing factors, such as the effect distance and internal walls have on signal strength, you may experience reduced Wi-Fi signal. To improve the Wi-Fi signal strength, adjust the distance or direction of your mobile device. Check with your mobile device again.
- Adjust the angle of the camera unit to aim at your monitoring areas.

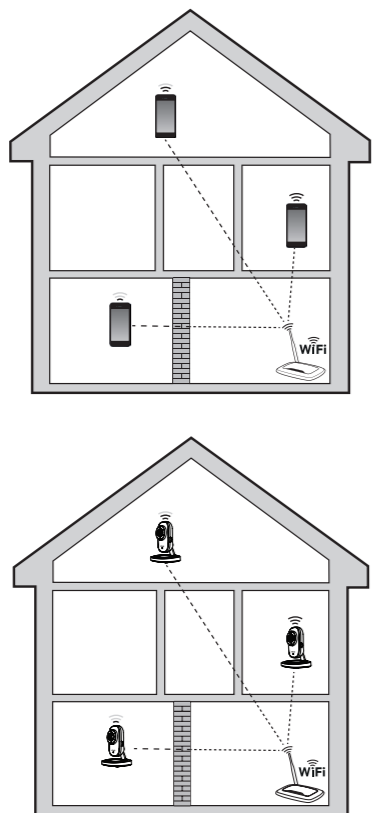

### INSERT MICRO SD CARD (OPTIONAL)

Your HD camera can capture videos of the monitoring area when motion is detected. The videos will be automatically saved in the camera's internal memory\*. You can also choose to save the videos to a micro SD card.

#### NOTE

- Your HD camera supports Class 4 or higher micro SD card, with storage capacity up to 64GB.

#### CAUTION

- Prior to inserting or ejecting the micro SD card installed in your HD camera, the camera must be powered off. To power off your camera, slide the **ON/OFF** switch to **OFF**.

\* The camera can store approximately 160 events, based on 10-second video clips at 720p HD resolution. Total number of events will increase or decrease based on the video resolution selected.

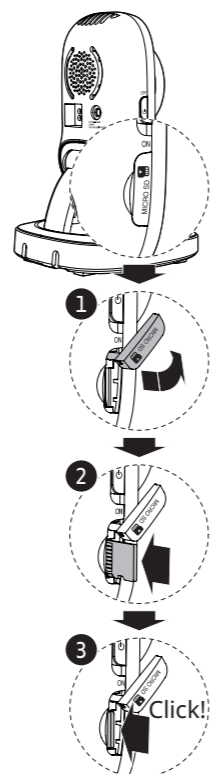

### MOUNT THE CAMERA UNIT (OPTIONAL)

#### NOTES

- The types of screws and anchors you need depend on the composition of the wall. You may need to purchase the screws and anchors separately to mount your HD cameras.
- Check for reception strength and camera angle before drilling the holes.

- Use a pencil to mark two holes in parallel. Make sure they are the same distance apart as the wall mount holes on the camera unit.

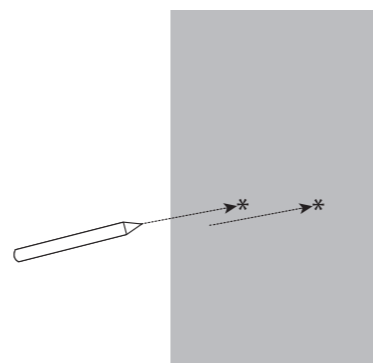

- Drill two holes in the wall.

- If you drill the holes into a stud, go to step 3. If you drill the holes into an object other than a stud, insert the wall anchors into the hole. Tap gently on the ends with a hammer until the wall anchors are flush with the wall.

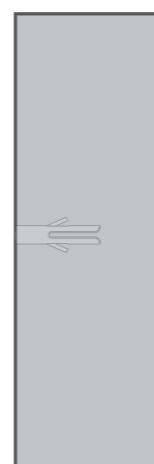

- Insert the screws into the holes and tighten the screws in the holes until only 1/4 inch of the screws are exposed.

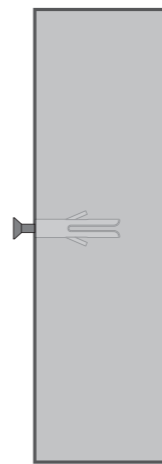

- Depending on your preference, choose the upright or lateral orientation to mount your unit. Align the wall mount holes at the bottom or at the rear side of the camera unit with the screws on the wall. Slide the camera unit down until it locks into place.

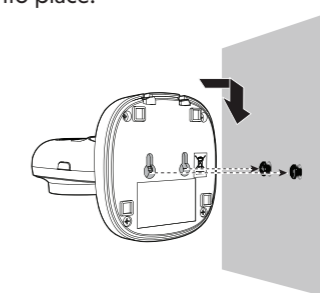

- OR -

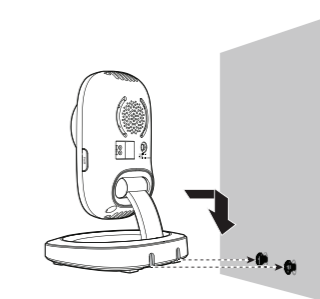

- Tilt or rotate to adjust camera angle.

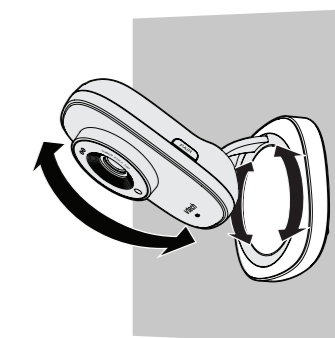

- OR -



### PAIR NEW CAMERA

You can add or replace any cameras.

The Wireless Monitoring family includes cameras **VC931**, **VC9411** and **VC9511**, which can be purchased separately. They can be paired to your camera account with the **MyVtech Cams** mobile app, for example, you can have a combination of **VC931**, **VC9411** and **VC9511**. You can pair a maximum of 10 cameras to your camera account.

For more details, refer to the online app manuals of **VC931**, **VC9411**, and **VC9511** in the **Help** page of the mobile app.

### GENERAL PRODUCT CARE

To keep this product working well and looking good, follow these guidelines:

- Avoid putting it near heating appliances and devices that generate electrical noise (for example, motors or fluorescent lamps).
- DO NOT expose it to direct sunlight or moisture.
- Avoid dropping the product or treating it roughly.
- Clean with a soft cloth.
- DO NOT immerse the HD camera in water and do not clean it under the tap.
- DO NOT use cleaning spray or liquid cleaners.
- Make sure the HD camera is dry before you connect it to the mains again.

### STORAGE

When you are not going to use the HD camera for some time, store the HD camera and the adapter in a cool and dry place.

### Q&A FREQUENTLY ASKED QUESTIONS

Below are the questions most frequently asked about the HD camera. If you cannot find the answer to your question in the below table, visit our website at [www.vtechphones.com](http://www.vtechphones.com), or call 1-844-848-8324 (1-844-84-VTECH) for customer service. In Canada, go to [www.vtechcanada.com](http://www.vtechcanada.com) or call 1-888-211-2005.

The LEDs on the HD camera are too bright. Can I turn them off?	You can turn off the LEDs of your HD camera. Read the <b>LED online indicator</b> section under <b>Camera settings</b> in the online app manual for instructions.
Why does HD camera not respond normally?	Try the following (in the order listed) for common cure: 1. Disconnect the power to the HD camera. 2. Wait a few minutes before connecting power back to the HD camera. 3. Turn on the HD camera 4. Run the mobile app again.
Why is my screen in black and white?	The HD camera has a light sensor that measures the ambient light. When the ambient light is dim, such as during nighttime or in a dark room, the camera activates its infrared LEDs, and displays the camera view in black and white.
Why does my HD camera show offline? Why is the connection lost every now and then?	The HD camera may lose the Internet connection. Check your network and the router setting.  Other electronic products may cause interference with your HD camera. Try installing your camera as far away from these electronic devices as possible.

### LIMITED WARRANTY

#### What does this limited warranty cover?

The manufacturer of this VTech Product warrants to the holder of a valid proof of purchase ("Consumer" or "you") that the Product and all accessories provided in the sales package ("Product") are free from defects in material and workmanship, pursuant to the following terms and conditions, when installed and used normally and in accordance with the Product operating instructions. This limited warranty extends only to the Consumer for Products purchased and used in the United States of America and Canada.

#### What will VTech do if the Product is not free from defects in materials and workmanship during the limited warranty period ("Materially Defective Product")?

During the limited warranty period, VTech's authorized service representative will repair or replace at VTech's option, without charge, a Materially Defective Product. If we repair the Product, we may use new or refurbished replacement parts. If we choose to replace the Product, we may replace it with a new or refurbished Product of the same or similar design. We will retain defective parts, modules, or equipment. Repair or replacement of the Product, at VTech's option, is your exclusive remedy. VTech will return the repaired or replacement Products to you in working condition. You should expect the repair or replacement to take approximately 30 days.

#### How long is the limited warranty period?

The limited warranty period for the Product extends for ONE (1) YEAR from the date of purchase. If VTech repairs or replaces a Materially Defective Product under the terms of this limited warranty, this limited warranty also applies to the repaired or replacement Product for a period of either (a) 90 days from the date the repaired or replacement Product is shipped to you or (b) the time remaining on the original one-year warranty; whichever is longer.

#### What is not covered by this limited warranty?

This limited warranty does not cover:

- Product that has been subjected to misuse, accident, shipping or other physical damage, improper installation, abnormal operation or handling, neglect, inundation, fire, water or other liquid intrusion; or
- Product that has been damaged due to repair, alteration or modification by anyone other than an authorized service representative of VTech; or
- Product to the extent that the problem experienced is caused by signal conditions, network reliability, or cable or antenna systems; or
- Product to the extent that the problem is caused by use with non-VTech accessories; or

- Product whose warranty/quality stickers, product serial number plates or electronic serial numbers have been removed, altered or rendered illegible; or
- Product purchased, used, serviced, or shipped for repair from outside the United States of America or Canada, or used for commercial or institutional purposes (including but not limited to Products used for rental purposes); or
- Product returned without a valid proof of purchase (see item 2 on the following part); or
- Charges for installation or set up, adjustment of customer controls, and installation or repair of systems outside the unit.

#### How do you get warranty service?

To obtain warranty service in the USA, please visit our website at [www.vtechphones.com](http://www.vtechphones.com) or call 1-844-848-8324 (1-844-84-VTECH). In Canada, go to [www.vtechcanada.com](http://www.vtechcanada.com) or call 1-888-211-2005. NOTE: Before calling for service, please review the user's manual - a check of the Product's controls and features may save you a service call.

Except as provided by applicable law, you assume the risk of loss or damage during transit and transportation and are responsible for delivery or handling charges incurred in the transport of the Product(s) to the service location. VTech will return repaired or replaced Product under this limited warranty. Transportation, delivery or handling charges are prepaid. VTech assumes no risk for damage or loss of the Product in transit. If the Product failure is not covered by this limited warranty, or proof of purchase does not meet the terms of this limited warranty, VTech will notify you and will request that you authorize the cost of repair prior to any further repair activity. You must pay for the cost of repair and return shipping costs for the repair of Products that are not covered by this limited warranty.

#### What must you return with the Product to get warranty service?

- Return the entire original package and contents including the Product to the VTech service location along with a description of the malfunction or difficulty; and
- Include a "valid proof of purchase" (sales receipt) identifying the Product purchased (Product model) and the date of purchase or receipt; and
- Provide your name, complete and correct mailing address, and telephone number.

#### Other limitations

This warranty is the complete and exclusive agreement between you and VTech. It supersedes all other written or oral communications related to this Product. VTech provides no other warranties for this Product. The warranty exclusively describes all of VTech's responsibilities regarding the Product. There are no other express warranties. No one is authorized to make modifications to this limited warranty and you should not rely on any such modification. State/Provincial Law Rights: This warranty gives you specific legal rights, and you may also have other rights, which vary from state to state or province to province.

Limitations: Implied warranties, including those of fitness for a particular purpose and merchantability (an unwritten warranty that the Product is fit for ordinary use) are limited to one year from the date of purchase. Some states/provinces do not allow limitations on how long an implied warranty lasts, so the above limitation may not apply to you. In no event shall VTech be liable for any indirect, special, incidental, consequential, or similar damages (including, but not limited to lost profits or revenue, inability to use the Product or other associated equipment, the cost of substitute equipment, and claims by third parties) resulting from the use of this Product. Some states/provinces do not allow the exclusion or limitation of incidental or consequential damages, so the above limitation or exclusion may not apply to you.

Please retain your original sales receipt as proof of purchase.