

Go to www.vtechphones.com
to register your product for
enhanced warranty support and
latest VTech product news.

VC7151
VC7151-101
VC7151-109
VC7152-201
VC7152-301

Wireless Monitoring System
with Cordless Telephone



vtech[®]
User's manual

Congratulations

on purchasing your new VTech product. Before using this product, please read **Important safety instructions**.

This manual has all the feature operations and troubleshooting necessary to install and operate your new VTech product. Please review this manual thoroughly to ensure proper installation and operation of this innovative and feature rich VTech product.

Compatible with
Hearing Aid T-Coil



Telephones identified with this logo have reduced noise and interference when used with most T-coil equipped hearing aids and cochlear implants. The TIA-1083 Compliant Logo is a trademark of the Telecommunications Industry Association. Used under license.

Register online to get an additional 3-month warranty!

Visit www.vtechphones.com.



Registration

Register your product online for enhanced warranty support.



Product news

Learn about the latest VTech products.

Important safety instructions

When using your telephone equipment, basic safety precautions should always be followed to reduce the risk of fire, electric shock and injury, including the following:

1. Read and understand all instructions.
2. Follow all warnings and instructions marked on the product.
3. Unplug this product from the wall outlet before cleaning. Do not use liquid or aerosol cleaners. Use a damp cloth for cleaning.
4. Do not use this product near water such as near a bath tub, wash bowl, kitchen sink, laundry tub or a swimming pool, or in a wet basement or shower.
5. Do not place this product on an unstable table, shelf, stand or other unstable surfaces.
6. Avoid placing the telephone system in places with extreme temperature, direct sunlight, or other electrical devices. Protect your phone from moisture, dust, corrosive liquids and fumes.
7. Slots and openings in the back or bottom of the telephone base and handset are provided for ventilation. To protect them from overheating, these openings must not be blocked by placing the product on a soft surface such as a bed, sofa or rug. This product should never be placed near or over a radiator or heat register. This product should not be placed in any area where proper ventilation is not provided.
8. This product should be operated only from the type of power source indicated on the marking label. If you are not sure of the type of power supply in your home or office, consult your dealer or local power company.
9. Do not allow anything to rest on the power cord. Do not install this product where the cord may be walked on.
10. Never push objects of any kind into this product through the slots in the telephone base or handset because they may touch dangerous voltage points or create a short circuit. Never spill liquid of any kind on the product.
11. To reduce the risk of electric shock, do not disassemble this product, but take it to an authorized service facility. Opening or removing parts of the telephone base or handset other than specified access doors may expose you to dangerous voltages or other risks. Incorrect reassembling can cause electric shock when the product is subsequently used.
12. Do not overload wall outlets and extension cords.
13. Unplug this product from the wall outlet and refer servicing to an authorized service facility under the following conditions:
 - When the power supply cord or plug is damaged or frayed.
 - If liquid has been spilled onto the product.
 - If the product has been exposed to rain or water.

- If the product does not operate normally by following the operating instructions. Adjust only those controls that are covered by the operation instructions. Improper adjustment of other controls may result in damage and often requires extensive work by an authorized technician to restore the product to normal operation.
 - If the product has been dropped and the telephone base and/or handset has been damaged.
 - If the product exhibits a distinct change in performance.
Avoid using a telephone (other than cordless) during an electrical storm. There is a remote risk of electric shock from lightning.
14. Avoid using a telephone (other than cordless) during an electrical storm. There is a remote risk of electric shock from lightning.
15. Do not use the telephone to report a gas leak in the vicinity of the leak. Under certain circumstances, a spark may be created when the adapter is plugged into the power outlet, or when the handset is replaced in its cradle. This is a common event associated with the closing of any electrical circuit. The user should not plug the phone into a power outlet, and should not put a charged handset into the cradle, if the phone is located in an environment containing concentrations of flammable or flame-supporting gases, unless there is adequate ventilation.
A spark in such an environment could create a fire or explosion. Such environments might include: medical use of oxygen without adequate ventilation; industrial gases (cleaning solvents; gasoline vapors; etc.); a leak of natural gas; etc.
16. Only put the handset of your telephone next to your ear when it is in normal talk mode.
17. Use only the adapters included with this product. Incorrect adapter polarity or voltage can seriously damage the product.
Telephone base adapter: Input 100-120V AC 200mA 60Hz; Output: 6V DC 600mA;
Charger adapter: Input 100-120V AC 150mA 60Hz; Output: 6V DC 400mA.
18. The power adapter is intended to be correctly oriented in a vertical or floor mount position. The prongs are not designed to hold the plug in place if it is plugged into a ceiling, under-the-table or cabinet outlet.
19. For pluggable equipment, the socket-outlet shall be installed near the equipment and shall be easily accessible.

SAVE THESE INSTRUCTIONS

Battery

- **CAUTION:** Use only the batteries indicated in this manual. There may be a risk of explosion if a wrong type of battery is used for the handset. Use only the supplied rechargeable battery or replacement battery pack (BT183342/BT283342) for the handset.
- Do not dispose of batteries in a fire. They may explode. Dispose of used battery according to the information in **The RBRC® seal**.
- Do not open or mutilate the battery. Released electrolyte is corrosive and may cause burns or injury to the eyes or skin. The electrolyte may be toxic if swallowed.
- Exercise care in handling batteries in order not to create a short circuit with conductive materials.
- Charge the battery provided with this product only in accordance with the instructions and limitations specified in this manual.

Precautions for users of implanted cardiac pacemakers

Cardiac pacemakers (applies only to digital cordless telephones):

Wireless Technology Research, LLC (WTR), an independent research entity, led a multidisciplinary evaluation of the interference between portable wireless telephones and implanted cardiac pacemakers. Supported by the U.S. Food and Drug Administration, WTR recommends to physicians that:

Pacemaker patients

- Should keep wireless telephones at least six inches from the pacemaker.
- Should NOT place wireless telephones directly over the pacemaker, such as in a breast pocket, when it is turned ON.
- Should use the wireless telephone at the ear opposite the pacemaker.

WTR's evaluation did not identify any risk to bystanders with pacemakers from other persons using wireless telephones.

About cordless telephones

- **Privacy:** The same features that make a cordless telephone convenient create some limitations. Telephone calls are transmitted between the telephone base and the cordless handset by radio waves, so there is a possibility that the cordless telephone conversations could be intercepted by radio receiving equipment within range of the cordless handset. For this reason, you should not think of cordless telephone conversations as being as private as those on corded telephones.
- **Electrical power:** The telephone base of this cordless telephone must be connected to a working electrical outlet. The electrical outlet should not be controlled by a wall switch. Calls cannot be made from the cordless handset if the telephone base is unplugged, switched off or if the electrical power is interrupted.

- **Potential TV interference:** Some cordless telephones operate at frequencies that may cause interference to televisions and VCRs. To minimize or prevent such interference, do not place the telephone base of the cordless telephone near or on top of a TV or VCR. If interference is experienced, moving the cordless telephone farther away from the TV or VCR often reduces or eliminates the interference.
- **Rechargeable batteries:** Exercise care in handling batteries in order not to create a short circuit with conducting material such as rings, bracelets and keys. The battery or conductor may overheat and cause harm. Observe proper polarity between the battery and the battery charger.
- **Nickel-metal hydride rechargeable batteries:** Dispose of these batteries in a safe manner. Do not burn or puncture the battery. Like other batteries of this type, if burned or punctured, they could release caustic material which could cause injury.

Table of Contents

Introduction	1	Set date and time	46
What's in the box	2	Temporary tone dialing	46
Overview	4	Quiet mode	46
Handset overview	4	Caller ID announce.....	47
Telephone base overview	7	Use caller ID to automatically set date	
Garage door sensor overview.....	11	and time.....	47
Open/closed sensor overview	12	Home area code	48
Sensor unit overview	12	Dial mode	48
Display icons overview	13	Telephone operations	49
Lights overview.....	15	Make a call	49
Installation setup	16	Answer a call	49
Telephone installation	16	End a call.....	49
Garage door sensor installation.....	20	Handset speakerphone	49
Open/closed sensor installation.....	24	Volume.....	49
Before use	30	Mute.....	50
Set date and time	30	Call waiting	50
Set answering system through voice guide	30	Find handset.....	50
Check for dial tone.....	30	Redial list	51
Operating range.....	31	Join a call in progress.....	51
Sensor	32	Push-to-talk (PTT)	51
Arm/Disarm the sensor alert system...	33	Intercom.....	52
Sensor mode	34	Transfer a call	52
Access an individual sensor menu	37	Answer an incoming call during an intercom call	52
Set alert schedule as always on.....	38	Phonebook	53
Set a time range for alerts	39	Add a phonebook entry	53
Turn off the alerts.....	40	Review and dial from the phonebook...	53
Alert notifications	41	Edit a phonebook entry	54
Test sensor signal strength.....	42	Delete a phonebook entry	54
Rename the sensor	43	Caller ID	55
Reset sensor alerts	43	Caller ID log.....	55
Sensor log	44	Review and dial a number in the caller ID log	55
Configure your telephone	45	Save a caller ID log entry to the phonebook.....	55
Using the menus.....	45	Delete a caller ID log entry	56
Set language	45	Delete all caller ID log entries.....	56

Call block	57	Use the built-in answering system and voicemail service...	70
Block unknown calls	57	Retrieve voicemail from telephone service	70
Add a call block list entry	57	Retrieve voicemail	70
Review the call block list.....	58	Set your voicemail number	70
Edit a call block list entry	58	Turn off the new voicemail indicators ...	71
Save a caller ID log entry to call block list.....	58	Expand your telephone system...72	
Delete a call block list entry	58	ECO mode	73
Sound settings	59	General product care	73
Key tone.....	59	Storage	73
Ringer tone	59	Frequently asked questions.....	74
Ringer volume	59	The RBRC® seal	77
Temporary ringer silencing	60	FCC, ACTA and IC regulations... 78	
About the built-in answering system and voicemail service ...61		California Energy Commission battery charging testing instructions	81
Set your built-in answering system	62	For C-UL and cETL compliance only	82
Turn the answering system on or off...62		Limited Warranty	85
Default announcement	62	Technical Specifications	87
Record your own announcement.....63		Disclaimer	88
Play the announcement.....63			
Reset the announcement	63		
Set number of rings	64		
Message alert tone.....64			
Recording time	65		
Voice guide	65		
Use your built-in answering system	66		
New message indication.....66			
Message playback.....66			
Delete all old messages	67		
Call intercept.....67			
Remote access	68		
Listen to messages from remote access	68		
Change sensor mode from remote access	69		
Remote access code.....69			

Introduction

This Wireless Monitoring System with VTech ULE consists of the telephone system, garage door sensor, open/closed sensor, and motion sensor. The telephone system is also sold separately or as:

- Telephone system and garage door sensor;
- Telephone system and open/closed sensor;
- A garage door sensor;
- An open/closed sensor; or
- A motion sensor.

Telephone system - Includes a telephone base and cordless handset (some models include additional handsets). The base and handset screens show call information and sensor alerts. The sensor sends alerts to the phone system or sends remote alert calls to other numbers you have specified.

Open/closed sensor - Apply this magnetic open/closed sensor to a door, window, or medicine cabinet to know if it is open or closed.

Garage door sensor - Detects when the garage door is open or closed.

Motion sensor - Lets you know when there are visitors, intruders, or pets moving around your home.

Sensor alert

When someone has arrived home, or you have forgotten to close the door, you will receive audible and text sensor alerts, for example, “*DOOR is open*”, on the handset and telephone base.

You can also program the phone system to make remote alert calls to up to three other telephone numbers. When you receive the remote alert call from the telephone base, you can choose to listen to the sound in your house; or you can choose to speak through the telephone base to the visitor or intruder. See pages 34 to 35.

Programmable alerts

Customize when and how you receive alerts.

When you receive alerts:

- A monitored garage door, in-house door, window, medicine cabinet opens, or there is motion in the monitored area;
- The monitored object is open for more than 15, 30, or 60 minutes if you have set a reminder for alerts;
- The monitored object is open, or a motion is detected, during a certain period of time if you have set a time range for alerts.

How you receive alerts:

- Audible and text sensor alerts on handset and telephone base;
- Receive a remote alert call on your cell phone or at other remote numbers you have programmed. See pages 34 to 35.

What's in the box

Your telephone package contains the following items. Save your sales receipt and original packaging in case it is necessary to ship your telephone for warranty service.

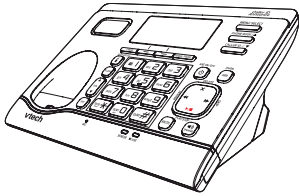

Telephone base



Telephone line cord

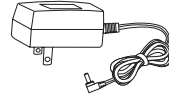

Telephone base adapter



Handset



Battery



Charger



Charger adapter

1 set for VC7151/VC7151-101/VC7151-109;
2 sets for VC7152-201;
3 sets for VC7152-301

1 set for VC7152-201;
2 sets for VC7152-301



Garage door sensor



Double-sided
mounting tape



Screw x 2

1 set for VC7151-101/
VC7151-109/
VC7152-201/
VC7152-301

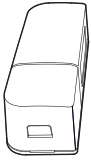

Open/closed
Sensor unit



Magnet unit

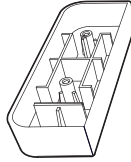

Spacer for
sensor unit

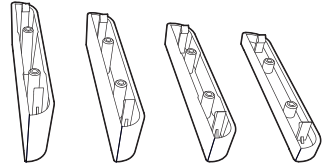

Spacers for magnet unit

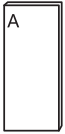

Double-sided
mounting tapes



Screw x 2



Small
screw x 2

1 set for VC7151-109

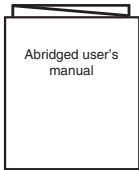

Abridged user's
manual

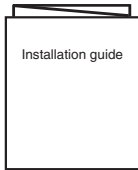

Installation guide

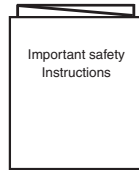

Important safety
Instructions

Overview

Handset overview

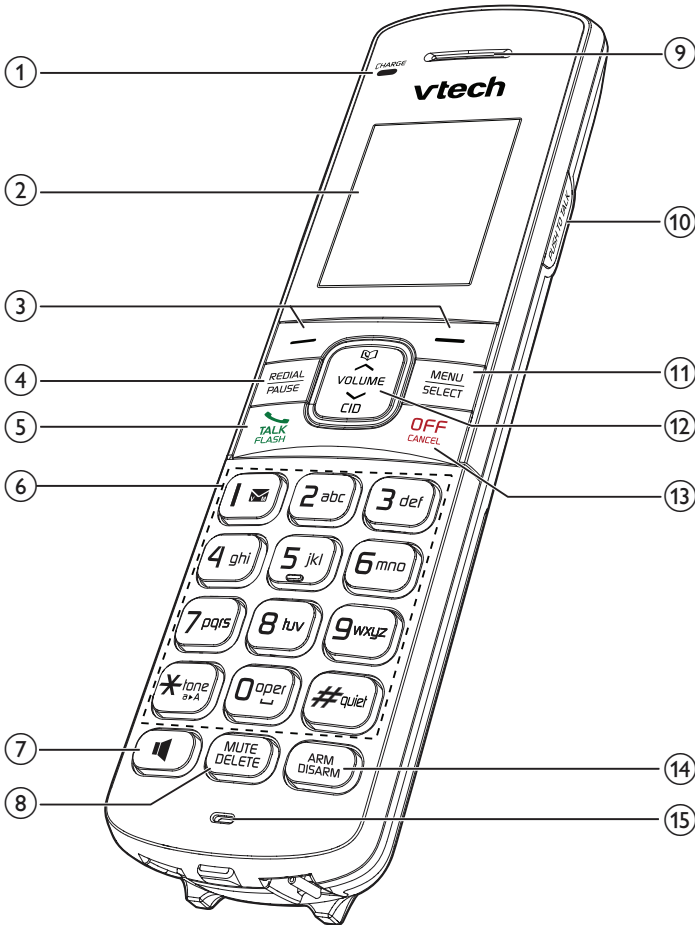

1 – CHARGE light

2 – LCD display

3 – Right Soft key

- Press to review the sensor status when the phone is not in use.
- While in a menu, press to select a menu item; or save an entry or setting.

Left Soft key

- Press to enter the sensor mode menu when the phone is not in use.
- Press to return to the previous menu.

4 – REDIAL/PAUSE

- Press repeatedly to review the redial list.
- Press and hold to insert a dialing pause while entering a number.

5 – TALK/FLASH

- Make or answer a call.
- Press to put the current call on hold when you receive an incoming call.
- Answer an incoming call when you hear a call waiting alert.

6 – Dialing keys

- Press to enter numbers or characters.

1

- Press repeatedly to add or remove **1** in front of the caller ID log entry before dialing or saving it to the phonebook.
- Press and hold to set or dial your voicemail number.

*

- While you have set the dial mode to pulse and on a call, press to switch to tone dialing temporarily.

- Press to add a space when entering names.

#

- Press and hold to enter quiet mode setting menu.
- Press repeatedly to show other dialing options when reviewing a caller ID log entry.

7 –

- Make or answer a call using the handset speakerphone.
- During a call, press to switch between the speakerphone and the earpiece.

8 – MUTE/DELETE

- Mute the microphone during a call.
- While editing names or numbers, press to delete a digit or character, or press and hold to delete all digits or characters.
- Delete the playing message on the handset.
- Silence the ringer temporarily while the handset is ringing.

9 – Earpiece

10 – PUSH TO TALK

- Press to display the **PUSH TO TALK (PTT)** menu to begin a PTT call when the phone is not in use.
- Press and hold to begin a one-to-group PTT call.
- Press and hold while talking in a PTT call.

11 – MENU/SELECT

- While in a menu, press to select an item; or save an entry or setting.

12 – VOLUME/

- Review the phonebook when the phone is not in use.
- Increase the listening volume during a call or message playback.
- Scroll up while in a menu, or in the phonebook, caller ID log, or redial list.
- Move the cursor to the right when entering numbers or names.

VOLUME//CID

- Review the caller ID log when the phone is not in use.
- Decrease the listening volume during a call or message playback.
- Scroll down while in a menu, or in the phonebook, caller ID log, or redial list.
- Move the cursor to the left when entering numbers or names.

13 – OFF/CANCEL

- Hang up a call.
- Silence the ringer temporarily while the handset is ringing.
- Press and hold to erase the missed call indicator while the phone is not in use.
- Press to return to the previous menu, or press and hold to return to idle mode, without making changes.

14 – ARM/DISARM

- Press to turn on or off the sensor alert system.

15 – Microphone

Telephone base overview

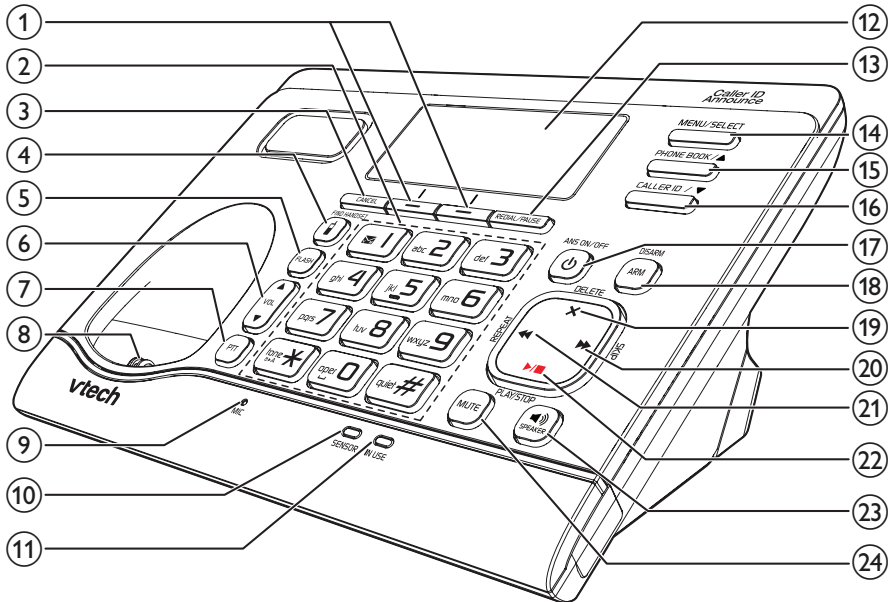

1 – Right Soft key

- Press to review the sensor status when the phone is not in use.
- While in a menu, press to select a menu item; or save an entry or setting.

Left Soft key

- Press to enter the sensor mode menu when the phone is not in use.
- Press to return to the previous menu.

2 – Dialing keys

- Press to enter numbers or characters.

1

- Press repeatedly to add or remove **1** in front of the caller ID log entry before dialing or saving it to the phonebook.
- Press and hold to set or dial your voicemail number.

tone

- While you have set the dial mode to pulse and on a call, press to switch to tone dialing temporarily.

oper

- Press to add a space when entering names.

#quiet

- Press and hold to enter quiet mode setting menu.
- Press repeatedly to show other dialing options when reviewing a caller ID log entry.

3 – CANCEL

- Silence the ringer temporarily while the telephone base is ringing.
- Press and hold to erase the missed call indicator while the phone is not in use.
- Press to return to the previous menu, or press and hold to return to idle mode, without making changes.

4 – /FIND HANDSET

- Press to page all system handsets.

5 – FLASH

- Press to put the current call on hold when you receive an incoming call.
- Answer an incoming call when you hear a call waiting alert.

6 – /VOL/

- Adjust the volume during a call or message playback.
- Adjust the telephone base ringer volume when the phone is not in use.

7 – PTT (Push to talk)

- Press to display the PTT menu to begin a PTT call.
- Press and hold to begin a one-to-group PTT call.
- Press and hold while talking in a PTT call.

8 – Charging pole

9 – MIC (Microphone)

10 – SENSOR light

- On when a sensor detects that one or more of the monitored garage door, in-house door, window, or medicine cabinet is opened, or when there is motion in the monitored area.

11 – IN USE light

- On when the telephone line is in use.
- On when the answering system is answering a call.
- On when you are registering a handset.
- Flashes quickly when there is an incoming call.
- Flashes quickly when you are deregistering all handsets.
- Flashes slowly when another telephone sharing the same line is in use.

12 – LCD display

13 – REDIAL/PAUSE

- Press repeatedly to review the redial list.
- Press and hold to insert a dialing pause while entering a number.

14 – MENU/SELECT

- While in a menu, press to select an item; or save an entry or setting.

15 – PHONEBOOK / ▲

- Review the phonebook when the phone is not in use.
- Scroll up while in a menu, or in the phonebook, caller ID log, or redial list.
- Move the cursor to the right when entering numbers or names.

16 – CALLER ID / ▼

- Review the caller ID log when the phone is not in use.
- Scroll down while in a menu, or in the phonebook, caller ID log, or redial list.
- Move the cursor to the left when entering numbers or names.

17 – ⏻/ANS ON/OFF

- Turn the answering system on or off.

18 – ARM/DISARM

- Press to turn on or off the sensor alert system.

19 – X/DELETE

- While editing names or numbers, press to delete a digit or character, or press and hold to delete all digits or characters.
- Delete the playing message.
- Press twice to delete all previously reviewed messages when the phone is not in use.

20 – ►/SKIP

- Skip to the next message.

21 – ◀/REPEAT

- Press to repeat a message.
- Press twice to play the previous message.

22 – ►/PLAY/STOP

- Play messages.
- Stop playing messages.

23 – /SPEAKER

- Make or answer a call using the speakerphone.
- Hang up a call.

24 – MUTE

- Mute the microphone during a call.
- Silence the ringer temporarily while the telephone base is ringing.

Garage door sensor overview

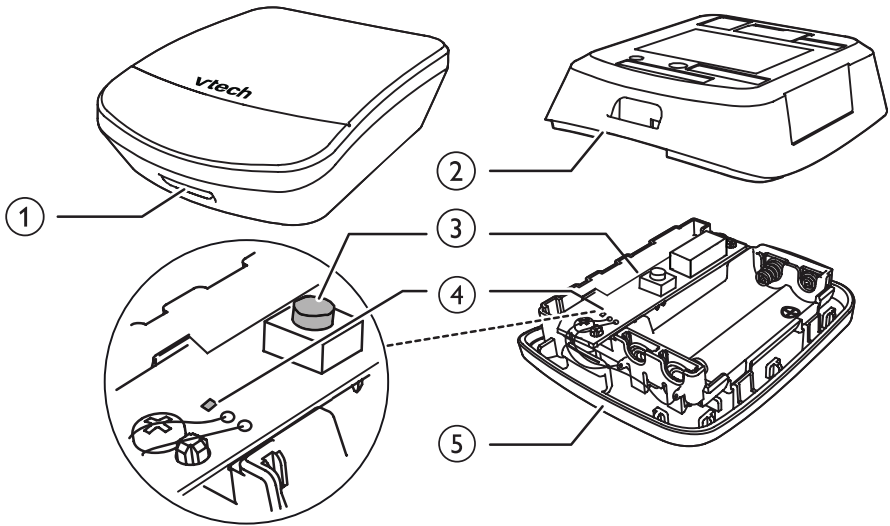

1 – Latch button

- Press to open the battery compartment case.

2 – Back cover

3 – Pair button

- When the sensor has been deregistered from the telephone base, press and hold to enter the registration mode.

4 – LED light

- Flashes red when the sensor is in the registration mode.

5 – Battery compartment case

Open/closed sensor overview

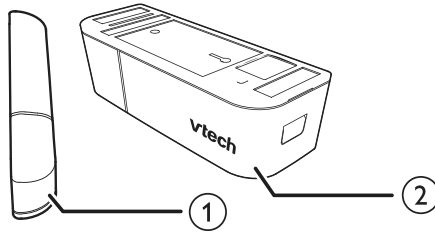

1 – Magnet unit

2 – Sensor unit

Sensor unit overview

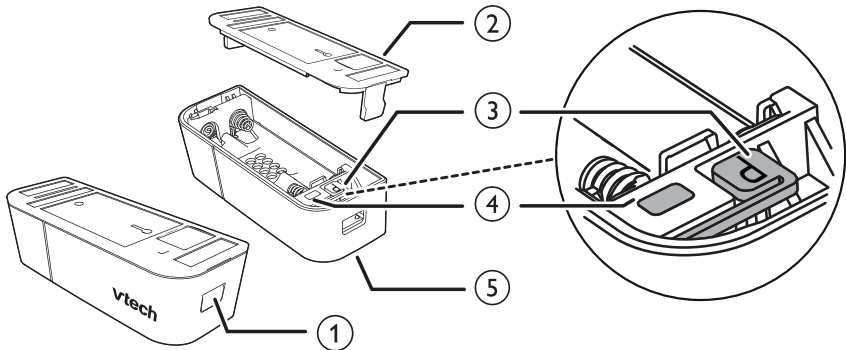

1 – Latch button

- Press to open the battery compartment case.

2 – Back cover

3 – Pair button

- When the sensor has been deregistered from the telephone base, press and hold to enter the registration mode.









4 – LED light

- Flashes red when the sensor is in the registration mode.









5 – Battery compartment case

Display icons overview

Handset icons

	Battery status - battery is charging (animated display).
	Battery status - the battery icon flashes when the battery is low and needs charging.
	Speakerphone - the handset speakerphone is in use.
	Ringer off - the handset ringer is off.
	New voicemail - you have new voicemail from your telephone service provider.
ANS ON	Answering system on - the answering system is turned on to answer calls.
	Message - you have new message in the built-in answering system.
	Search bar icon - appears when in the phonebook menu.
ECO	ECO mode - activates automatically to reduce power consumption when the handset is within range from the telephone base.
NEW	New caller ID log - displays in caller ID log when there are new missed calls.
MISSED	Missed alerts in sensor log - displays in sensor log when there are new missed alerts from sensors.
###/###	Index - shows the entry number of the sensor status, or in the sensor log, phonebook, caller ID log, or call block list that is currently being viewed, out of the total number of entries.
MUTE	MUTE - the handset microphone is off.
	Sensor - the garage door, in-house door, window, or medicine cabinet is opened.
	Missed alerts in idle mode - displays in idle mode when there are new missed alerts from sensors.
BL	Armed local mode - displays when the sensor alert system is turned on, and is set to receive alerts locally. Alerts are received on the telephone system only.
BR	Armed remote mode - displays when the sensor alert system is turned on, and is set to receive alerts remotely. Alerts are received at the stored telephone numbers.

Telephone base icons



	Ringer off - the telephone base ringer is off.
	New voicemail - you have new voicemail from your telephone service provider.
ANS ON	Answering system on - the answering system is turned on to answer calls.
	Message - you have new message in the built-in answering system.
	Search bar icon - appears when in the phonebook menu.
ECO	ECO mode - activates automatically to reduce power consumption when the handset is within range from the telephone base.
NEW	New caller ID log - displays in caller ID log when there are new missed calls.
MISSED	Missed alerts in sensor log - displays in sensor log when there are new missed alerts from sensors.
###/###	Index - shows the entry number of the sensor status, or in the sensor log, phonebook, caller ID log, or call block list that is currently being viewed, out of the total number of entries.
MUTE	MUTE - the telephone base microphone is off.
	Sensor - the garage door, in-house door, window, or medicine cabinet is opened.
	Missed alerts in idle mode - displays in idle mode when there are new missed alerts from sensors.
	Armed local mode - displays when the sensor alert system is turned on, and is set to receive alerts locally. Alerts are received on the telephone system only.
	Armed remote mode - displays when the sensor alert system is turned on, and is set to receive alerts remotely. Alerts are received at the stored telephone numbers.

Lights overview

Handset lights

	On when the handset speakerphone is in use.
CHARGE	On when the handset is charging in the telephone base or handset charger.

Telephone base lights

SENSOR	On when the garage door, in-house door, window, or medicine cabinet is opened.
IN USE	On when: <ul style="list-style-type: none">• the telephone line is in use;• the answering system is answering a call; or• you are registering a handset. Flashes quickly when: <ul style="list-style-type: none">• there is an incoming call; or• you are deregistering all handsets.
 /ANS ON/OFF	On when the answering system is turned on.
MUTE	On when the telephone base microphone is muted.
 /PLAY/STOP	On when the answering system is playing a message. Flashes slowly when there is a new message.

Sensor light

LED light	On for five seconds when the sensor is successfully registered to the telephone base. Flashes slowly when the sensor is registering to the telephone base.
------------------	---

Installation setup

Telephone installation

You can choose to connect the telephone base for desktop usage or wall mounting.

NOTES

- Use only the adapters provided.
- Make sure the electrical outlets are not controlled by wall switches.
- The adapters are intended to be correctly oriented in a vertical or floor mount position. The prongs are not designed to hold the plug in place if it is plugged into a ceiling, under-the-table or cabinet outlet.

TIP

- If you subscribe to digital subscriber line (DSL) high-speed Internet service through your telephone line, make sure you install a DSL filter (not included) between the telephone line cord and telephone wall jack. Contact your DSL service provider for more information.

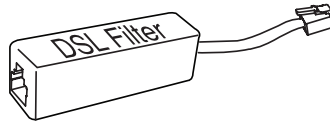

Connect the telephone base

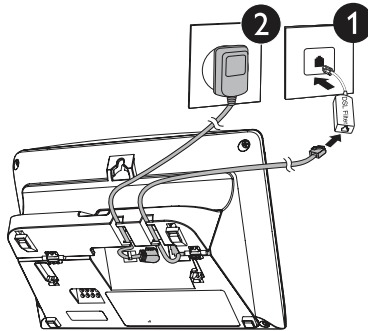

Connect the charger

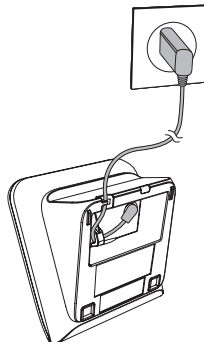

Install the handset battery

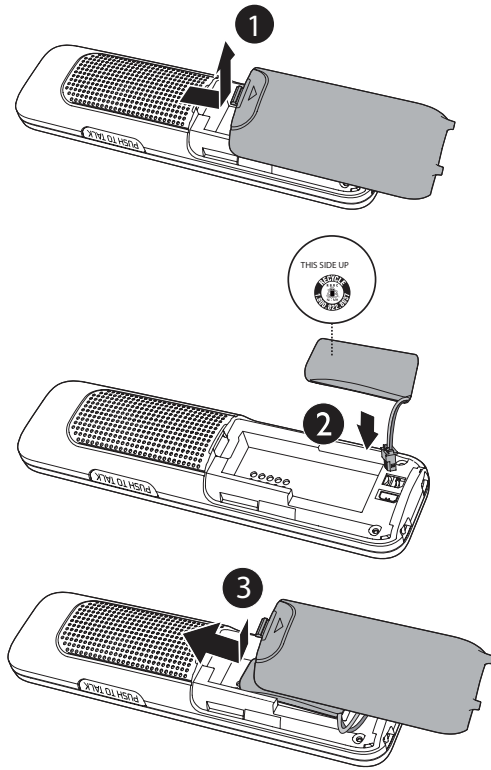

NOTES

- Use only the supplied battery.
- If the handset will not be used for a long time, disconnect and remove the battery to prevent possible leakage.

Charge the battery

Place the handset in the telephone base or a charger to charge.

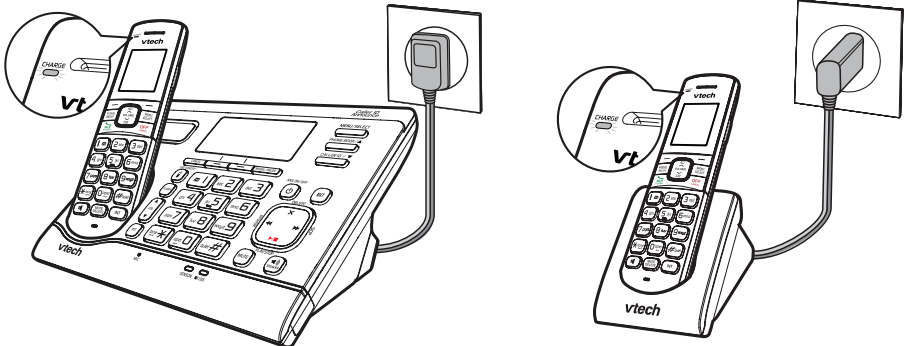

Handset battery

Once you have installed the battery, the battery indicators show the battery status (see the table followed).

NOTES

- For best performance, keep the handset in the telephone base or charger when not in use.
- The battery is fully charged after 12 hours of continuous charging.

Battery indicators	Battery status	Action
The screen is blank, or shows Place in charger and \Rightarrow flashes.	The battery has no charge or very little charge. The handset cannot be used.	Charge without interruption (at least 30 minutes).
The screen shows Low battery and \Rightarrow flashes.	The battery has enough charge to be used for a short time.	Charge without interruption (at least 30 minutes).
The screen shows HANDSET X.	The battery is charged.	To keep the battery charged, place it in the telephone base or charger when not in use.

Mount the telephone base

The telephone comes ready for tabletop use. If you have already installed the telephone for tabletop use, unplug the telephone line cord from the telephone wall jack, and unplug the telephone base power adapter from the wall outlet before mounting your telephone on a wall. Follow the steps below to mount your telephone on a wall.

1. Press down on the tabs on the wall mount bracket on the telephone base to release it from tabletop orientation.

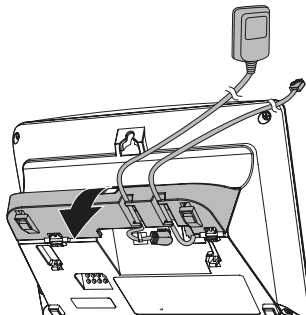

2. Rotate the wall mount bracket down to wall mount position and then push it into the telephone base until it clicks into place.

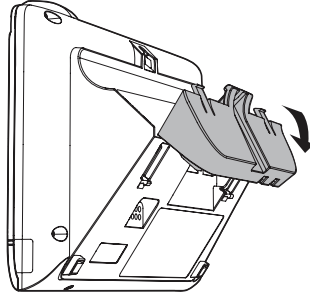

3. Plug the telephone line cord (or DSL filter) into the wall jack. Align the holes on the back of the telephone base with the standard wall plate. Slide the bracket down until it clicks securely in place. Connect the power adapter to the telephone base and an electrical outlet not controlled by a wall switch.

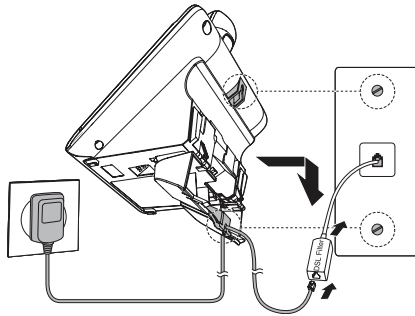

4. Slide the telephone base down until it clicks securely in place. Bundle the telephone line cord and power adapter cord neatly with twist ties if necessary.

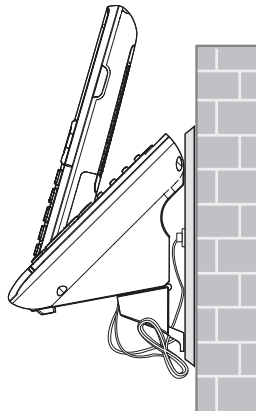

Garage door sensor installation

Power on the garage door sensor

The batteries are pre-installed in your garage door sensor.

To activate the batteries:

Pull the battery tab off from the sensor to activate the batteries.

The garage door sensor powers on.





NOTE

- The garage door sensor is already pre-registered to the telephone base.

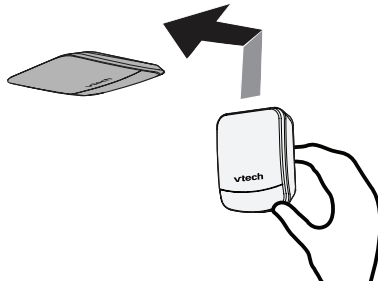
Check the garage door sensor before use



1. Hold the sensor and tilt it to 90 degrees, with the **vtech** logo facing downward.
 - You will hear an announcement alert - “GARAGE X* is open” from the handset and the telephone base.
 - The handset and the telephone base will display “**GARAGE X is open**”, and then .
 - The **SENSOR** light on the telephone base will turn red.
2. Tilt the sensor to 90 degrees to the original upright position.
 -  will disappear from the handset and the telephone base.
 - The **SENSOR** light on the telephone base will turn off.

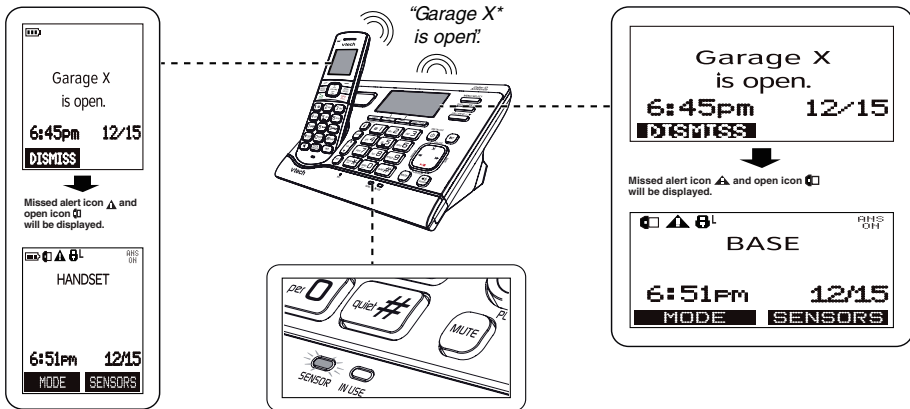

NOTE

- There is a component inside this sensor to detect orientation. It is normal to hear a rattling sound when tilted.

Test the garage door sensor's signal strength

You can mount the Garage Door Sensor on a garage door that raises overhead. Before mounting the garage door sensor, make sure you test if the location you install the garage door sensor is in range from the telephone base.

1. Take the sensor to the desired mounting location on the garage door, and use adhesive tape to hold it temporarily in place.
2. Use your handset to enter the **Sensor setup** menu, and then the Sensor setup menu. Follow the steps to test the sensor's signal strength. When the screen displays **Good signal. Good location for sensor.** Press **OK**. The testing is complete.

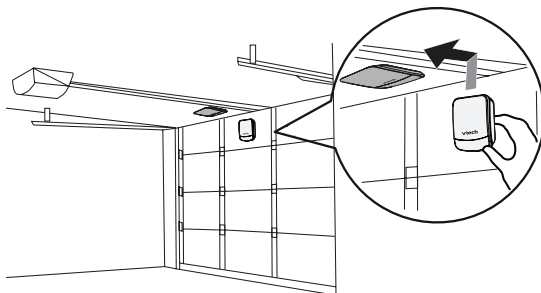

NOTES

- If you do not receive an alert when you open the garage door, move your telephone base closer to the garage or move the sensor closer to the telephone base.
- Depending on surroundings and obstructing factors, like concrete garage walls, a tall metal storage cabinet, or an SUV, the sensor may not transmit to the base properly.

* **GARAGE X** refers to the sensor's name. **X** refers to the system-assigned number of the sensor.

Mount the garage door sensor

You can choose to use mounting tape or screws to mount the sensor.

NOTE

- Make sure the mounting surface is fully cleaned. A textured surface or any imperfections to a smooth surface can keep the mounting tape from making a strong bond.

Mount with tapes:

1. Attach the mounting tape onto the rectangular area of the back cover, and then stick the garage door sensor onto the garage door.
2. Firmly press the sensor for 30 seconds to ensure full contact on the surface area.

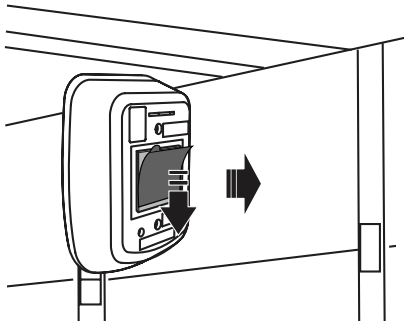

Mount with screws:

1. Press the latch button on the sensor to open the battery compartment case.

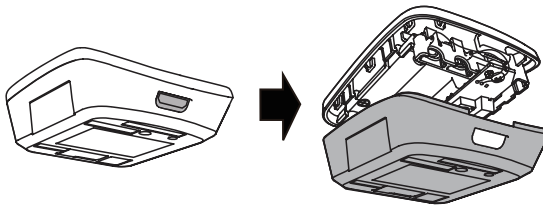

2. Use the two holes on the back cover to mark the desired location of the garage door.

3. Then, remove the back cover and drill two holes into the garage door.

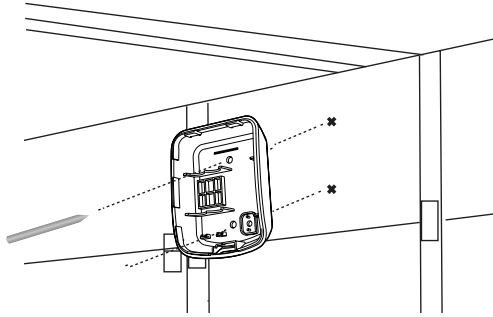

4. Align the holes on the back cover of the sensor with the holes on the garage door. Stick the back cover onto the door. Tighten the screws into the holes to secure the back cover onto the garage door.



- You may also choose to attach the mounting tape onto the back cover to strengthen the bond, if necessary.

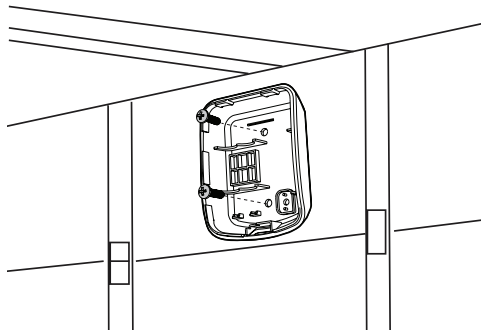

5. Push the battery compartment case back to the back cover on the garage door until it clicks into place.

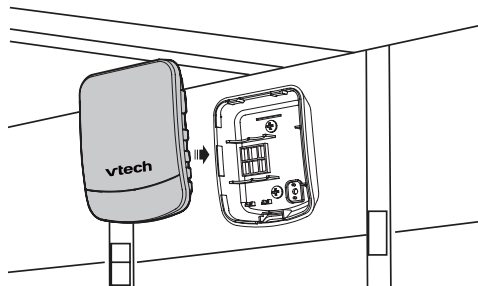

Open/closed sensor installation

Power on the open/closed sensor

The batteries are pre-installed in your open/closed sensor.

To activate the batteries:

Pull the battery tab off from the sensor to activate the batteries.
The garage door sensor powers on.

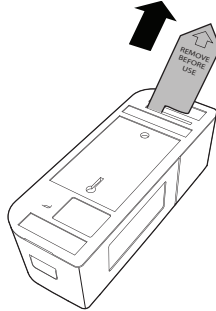



NOTE

- The open/closed sensor is already pre-registered to the telephone base.

Check the open/closed sensor before use

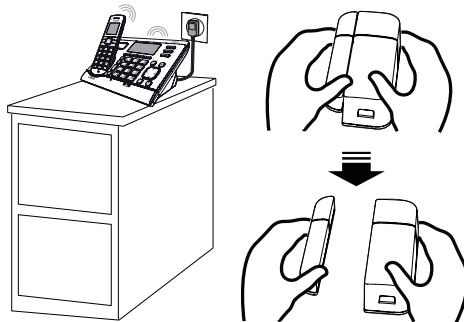
1. Separate the sensor unit from the magnet unit.



- You will hear an announcement alert - “Open/Closed X* is open”, from the handset and the telephone base.
 - The handset and the telephone base will display “**Open/Closed X is open**”, and then .
 - The **SENSOR** light on the telephone base will turn red.
2. Combine the sensor unit with the magnet unit.
-  will disappear from the handset and the telephone base.
 - The **SENSOR** light on the telephone base will turn off.

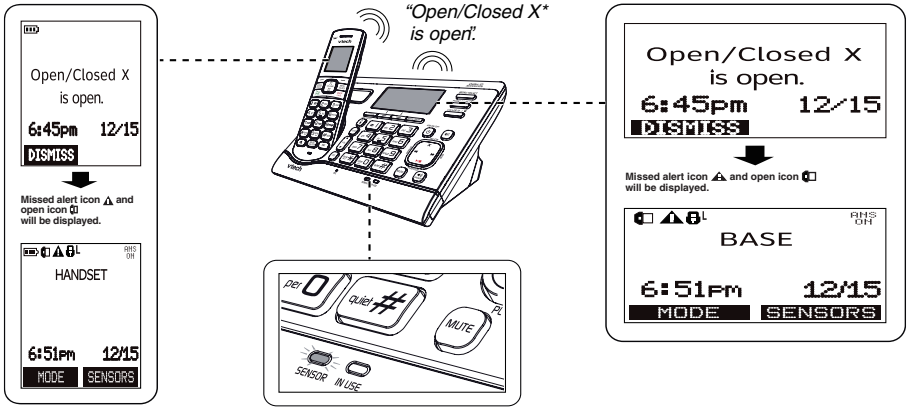

Test the open/closed sensor's signal strength

You can mount the Open/Closed Sensor on a door, window, medicine cabinet, or any object that opens or closes.

1. Take the sensor unit and magnet unit to the desired mounting location, and use adhesive tape to hold them temporarily in place at the object and the frame.
2. Use your handset to enter the **Sensor setup** menu, and then the Sensor setup menu. Follow the steps to test the sensor's signal strength. When the screen displays **Good signal. Good location for sensor.** Press **OK**. The testing is complete.

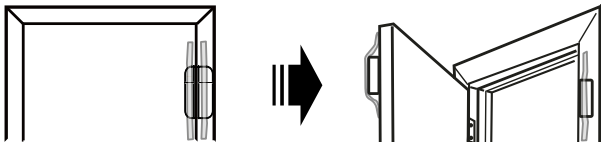

NOTES

- If you do not receive an alert when you open the door, window, or medicine cabinet, move your telephone base closer to the mounting location or move the sensor closer to the telephone base.
- Depending on surroundings and obstructing factors, like walls or cabinets, the sensor may not transmit to the base properly.

* **Open/Closed X** refers to the sensor's name. **X** refers to the system-assigned number of the sensor.

Mount the open/closed sensor

We recommend you to mount the magnet unit on a door, window, or medicine cabinet, and mount the sensor unit on its respective frame.

NOTES

- Make sure the mounting surface is clean. A textured surface or any imperfections to a smooth surface can keep the mounting tape from making a strong bond.
- Make sure you align the magnet unit with sensor unit when mounting.
- The distance between the sensor unit and magnet unit must be **less than 1 cm (0.4 inch)**.
- The door images in this installation guide are for conceptual reference only.

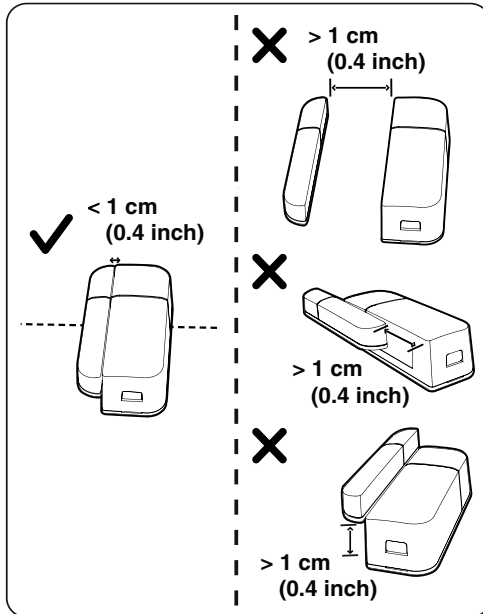

TIPS

- If there is a difference in level between the door, window, or medicine cabinet and its respective frame, or the frame is too narrow or has some decorative molding, you can choose to mount the open/closed sensor with spacer. You can also mount the magnet unit on the frame, and the sensor unit on the door, window, or medicine cabinet instead.
- You can choose to mount the sensor unit with mounting tape first, and then use screws later if you decide to mount it at that location for long term.

Mount the magnet unit

Without Spacer

Mount with tape

1. Attach mounting tape **C** onto the rectangular area at the rear side of the magnet unit,
2. Stick the magnet unit onto the door.

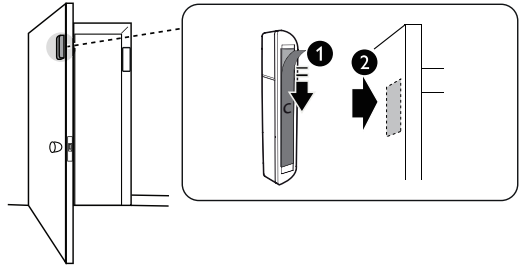

With Spacer

Mount with screws

You can choose one out of the four spacers with suitable height, and then add it to the magnet unit.

1. Push the spacer towards the magnet unit until it securely clicks into place.
2. Attach mounting tape **C** onto the rectangular area at the rear side of the spacer.
3. Stick the magnet unit onto the door.

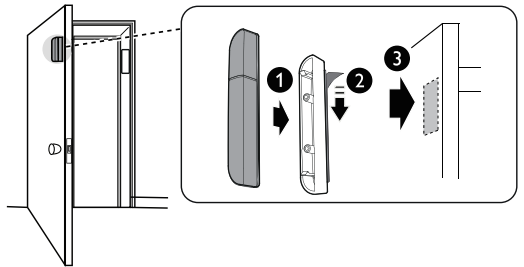

Mount the sensor unit

Without Spacer

Mount with tape

1. Attach the mounting tape **B** onto the rectangular area at the rear side of the back cover
2. Stick the sensor unit onto the frame.

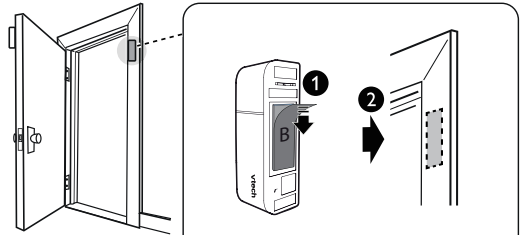

-OR-

Mount with screws

1. Press the latch button on the sensor unit to open the battery compartment case.
2. Use a pencil to mark two holes on the desired location on the frame, with the aid of the two holes on the back cover of the sensor unit. Then, remove the back cover and drill two holes into the frame.
3. Align the holes on the back cover with the holes on the frame. Tighten the small screws into the holes to secure the back cover onto the frame.
4. Push the battery compartment case back onto the mounted back cover until it securely clicks into place.

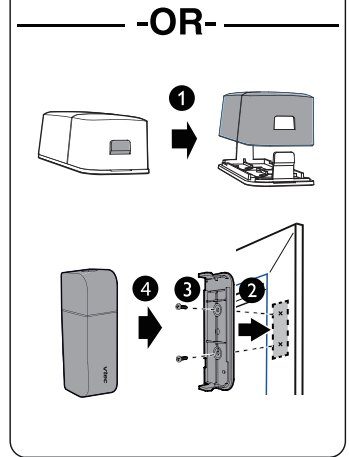

With Spacer

Mount spacer with tape

1. Attach mounting tape **A** onto the rectangular area at the rear side of the spacer.
2. Stick the spacer onto the frame.

-OR-

Mount spacer with screws

1. Use a pencil to mark two holes on the desired location on the frame, with the aid of the two holes on the spacer of the sensor unit. Then, remove the spacer and drill two holes into the frame.
2. Align the holes on the spacer with the holes on the frame. Tighten the large screws into the holes to secure the spacer onto the frame.

Mount sensor unit onto spacer

3. Press the latch button on the sensor unit to open the battery compartment case from the back cover.
4. Align the holes on the battery compartment back cover with the holes on the mounted spacer.
5. Tighten the small screws into the holes to secure the back cover of the sensor onto the mounted spacer.
6. Push the battery compartment case back onto the mounted spacer until it securely clicks into place.

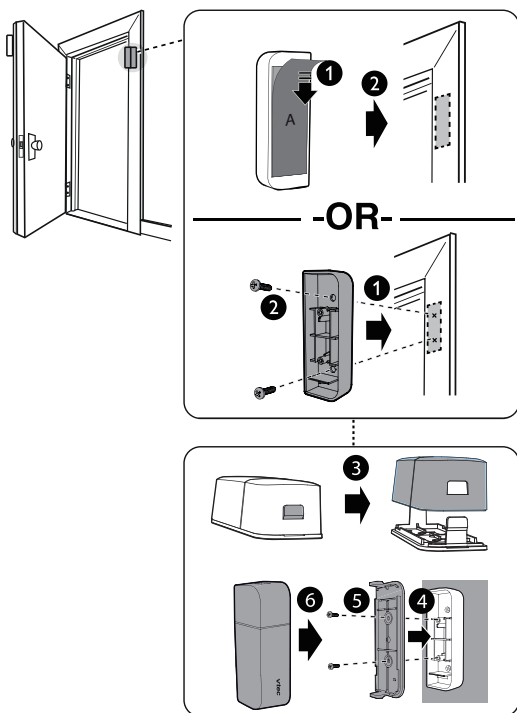

Before use

After you install your telephone, or power returns following a power outage, the telephone system will prompt you to set the date and time first. Then, it will ask you to set the answering system through voice guide.

Set date and time

NOTE

- Make sure you set the date and time including the year correctly; otherwise the answering system does not announce the correct day of the week for your recorded messages time stamp.

1. Use the dialing keys (**0-9**) to enter the month, date, and year, and then press **NEXT**.
2. Use the dialing keys (**0-9**) to enter the hour and minute.
3. Press \vee or \wedge on the handset, or **CALLER ID / \blacktriangledown** or **PHONEBOOK / \blacktriangle** on the telephone base to scroll to choose **AM** or **PM**, and then press **SAVE** to save.



After the setting for the date and time, the screen will display **Start voice guide to set up Answering system now?**.

Set answering system through voice guide

This feature assists you to do the basic setup of the answering system. You can follow the voice guide to record your own announcement, set the number of rings and the message alert tone.

1. Press **YES** to start the voice guide for the answering system setup. You hear the voice prompt *“Hello! This voice guide will assist you with the basic setup of your answering system.”*
2. Setup your answering system by inputting the designated numbers as instructed in the voice guide.

Check for dial tone

Press  or  on the handset, or  on the telephone base. If you hear a dial tone, the installation is successful.





If you do not hear a dial tone:

- Make sure the installation procedures described above are properly done.
- It may be a wiring problem. If you have changed your telephone service to digital service from a cable company or a VoIP service provider, the telephone line may need to be rewired to allow all existing telephone jacks to work. Contact your cable/VoIP service provider for more information.

Operating range

This cordless telephone operates with the maximum power allowed by the Federal Communications Commission (FCC). Even so, this handset and telephone base can communicate over only a certain distance - which can vary with the locations of the telephone base and handset, the weather, and the layout of your home or office.

When the handset is out of range, the handset displays **Out of range OR no power at base** and **Put HS on base to power base** alternately.

If there is a call while the handset is out of range; it may not ring, or if it does ring, the call may not connect well when you press  or . Move closer to the telephone base, and then press  or  to answer the call. If the handset moves out of range during a telephone conversation, there may be interference. To improve reception, move closer to the telephone base.

Sensor

The sensor helps you to monitor your garage door, in-house door, window, medicine cabinet, or an area around your house. This keeps you notified if the monitored object is open or closed, or someone has accessed an area that is off-limits.

When any of the monitored garage door, in-house door, window, or medicine cabinet opens, or when there is motion in the monitored area, the sensor sends an alert to your telephone. Both the base and handsets announce and display alert messages.

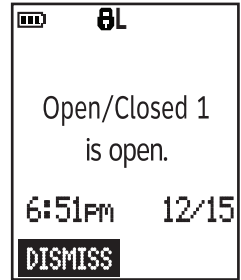

The telephone system has a sensor log. It stores the latest 50 alert messages from all sensors. You can review when and which sensor was triggered. You can also use the individual sensor's menu to check the current sensor status and sensor log.

You can choose to receive alert calls at other telephones. Store up to three desired telephone numbers, for example your cell phone number and office phone number, into the telephone base. You will be notified even when you are away from home. When you receive the remote alert call from the telephone base, you can choose to listen to the sound in your house; or you can choose to speak through the telephone base to the **visitor or intruder**.

Follow the instructions in this section to turn on or off the sensor alert system and change sensor mode; or to set sensor alert schedule, test the sensor signal strength, rename the sensor, reset sensor alerts, and review sensor logs.

NOTE

- When there are more than four handsets registered, the telephone system supports sensor alerts for the first four registered handsets only.

Arm/Disarm the sensor alert system

You can use the **ARM/DISARM** key on the handset or telephone base to turn on or off the sensor alerts immediately, by arming or disarming the sensor alert system.

To disarm the sensor alert system:

- When the sensor alert system is in armed mode, press **DISARM** on the handset or telephone base to turn off all sensor alerts.

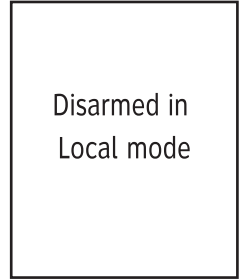

NOTE

- The  icon will still display on the handset and telephone base. The **SENSOR** light on the telephone base will also remain on.



To arm the sensor alert system:

- When the sensor alert system is in disarmed mode, press **ARM** on the handset or telephone base to turn on the sensor alerts.

In idle mode, the handset and telephone base will display  **L** when the current sensor mode is **Local**, or  **R** when the current sensor mode is **Remote**.

NOTE

- The sensor alert behavior depends on the current settings of individual sensor's alert schedule and the sensor notification type. Refer to the following sections for more information.

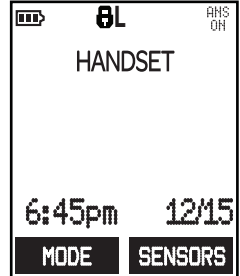
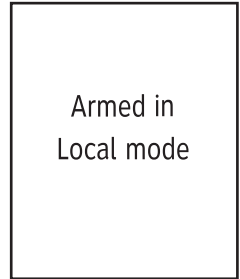

Sensor mode

You can choose **Local** mode to receive alerts at the telephone system, or **Remote** mode to receive calls at other numbers you have specified. This allows you to get notified even when you are away from home. The preset sensor mode is **Local**.

In **Remote** mode, when you receive the remote alert call, you will hear the alert message and then you can choose to listen to the sound in your house; or you can choose to speak through the telephone base to the visitor or intruder.

	Receive alerts at the telephone system	Receive calls at up to 3 desired phones
Remote	--	✓
Local	✓	--

1. Press **MODE** on the handset or telephone base when idle.
2. Press \downarrow or \uparrow on the handset, or **CALLER ID / \blacktriangledown** or **PHONEBOOK / \blacktriangle** on the telephone base to scroll to choose **Remote** or **Local**, and then press **SELECT** to select or save.
 - When **Remote** is chosen, and no telephone number has been previously set, you will be prompted to set the telephone numbers for remote calls.

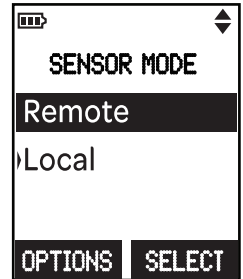

NOTES

- In **Remote** mode, the stored telephone numbers will ring in sequence. If the first telephone number is busy or does not pick up the remote call, the telephone system will call the second telephone number, and so on.

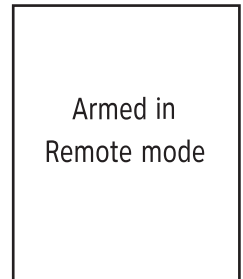

Edit numbers for remote calls:

You can add, edit, or delete a telephone number for remote calls.

1. Press **MODE** on the handset or telephone base when idle.
2. Press \vee or \wedge on the handset, or **CALLER ID / \vee** or **PHONEBOOK / \blacktriangle** on the telephone base to scroll to choose **Remote**, and then press **OPTIONS**.
3. Press **SELECT** to select **Set tel number**.
4. Press \vee or \wedge on the handset, or **CALLER ID / \vee** or **PHONEBOOK / \blacktriangle** on the telephone base to scroll to the desired slots (**1**, **2**, or **3**), and then press **SELECT**.
5. Use the dialing keys to enter the number.
6. Press **SAVE** to save.



Set time delay for remote calls:

You can choose to set an exit or entrance delay time for the remote calls, so that when a sensor is triggered when you exit or enter your home within the delay time, you will not receive the unnecessary remote call.

For example, when you are about to leave home, you can set the exit delay time to **5 minutes**. Once the delay is set, you will not receive a remote call even when you open the door within those five minutes.

As for the entrance delay time, if you set it to **1 minute**, you will receive the remote call a minute after opening the door as you come home, unless you press **MODE** and then choose **Local** mode, or press **DISARM** on the handset or telephone base within that minute.

If you want to be notified immediately whenever a door is opened, we recommend you to set it as **0 minutes**.

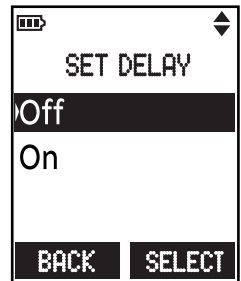

- At the last 10 seconds of exit delay time, there will be a beep every second.
 - When a delay time has been set, there will not be any local or remote call alerts when a monitored garage door, in-house door, window, or medicine cabinet is open, or when there is motion in the monitored area, during the delay time.
 - If you are not able to exit home before the delay time ends, you can restart the delay time again when you are ready to leave:
 - switch the sensor mode to **Local**, and then switch it back to **Remote**; or
 - press **DISARM** to switch the sensor alert system to **Disarmed**, and then press **ARM** to switch it back to **Armed**.
 - The delay time set will be activated when:
 - the sensor mode is switched to **Remote** from the **Armed-Local** mode; or
 - the sensor alert system is switched to **Armed** from the **Disarmed-Remote** mode.
1. Press **MODE** on the handset or telephone base when idle.
 2. Press \vee or \wedge on the handset, or **CALLER ID / \blacktriangledown** or **PHONEBOOK / \blacktriangle** on the telephone base to scroll to choose **Remote**, and then press **OPTIONS**.
 3. Press \vee or \wedge on the handset, or **CALLER ID / \blacktriangledown** or **PHONEBOOK / \blacktriangle** on the telephone base to scroll to choose **Set delay** and then press **SELECT**.
 4. Press \vee or \wedge on the handset, or **CALLER ID / \blacktriangledown** or **PHONEBOOK / \blacktriangle** on the telephone base to scroll to choose **On**, and then press **SELECT** to proceed to choose the exit delay time.
 - To skip time delay setting, scroll to choose **Off**, and then press **SELECT**.
 5. Press \vee or \wedge on the handset, or **CALLER ID / \blacktriangledown** or **PHONEBOOK / \blacktriangle** on the telephone base to scroll to choose **3 minutes**, **5 minutes** or **8 minutes**, and then press **SELECT** to proceed to choose the entrance delay time.
 6. Press \vee or \wedge on the handset, or **CALLER ID / \blacktriangledown** or **PHONEBOOK / \blacktriangle** on the telephone base to scroll to choose **0 minutes**, **1 minute** or **3 minutes**, and then press **SELECT** to save the delay time.

Access an individual sensor menu

The sensors menus appear when there is at least one sensor registered to the telephone base.

1. Press **SENSORS** on the handset or telephone base when idle, and then press \vee or \wedge on the handset, or **CALLER ID / \blacktriangledown** or **PHONEBOOK/ \blacktriangle** on the telephone base to scroll to the desired sensor.
-OR-
 - i. Press **MENU** when the phone is not in use.
 - ii. Press \vee or \wedge on the handset, or **CALLER ID / \blacktriangledown** or **PHONEBOOK/ \blacktriangle** on the telephone base to scroll to **Sensors**, and then press **SELECT**.
 - iii. Press \vee or \wedge on the handset, or **CALLER ID / \blacktriangledown** or **PHONEBOOK/ \blacktriangle** on the telephone base to scroll to the desired sensor, and then press **SELECT**.
2. Press **OPTIONS** to enter the individual sensor menu.
3. Press \vee or \wedge on the handset, or **CALLER ID / \blacktriangledown** or **PHONEBOOK/ \blacktriangle** on the telephone base to scroll until the screen displays the desired feature menu.
4. Press **SELECT** to enter that menu.
 - To return to the previous menu, press **CANCEL**.
 - To return to idle mode, press and hold **CANCEL**.

Set alert schedule as always on

The default setting of sensors' alert schedule is **Always on**. You will receive an announcement alert - "*Sensor X* is open*" or "*Motion X* sensor detected motion*", every time a monitored garage door, in-house door, window, or medicine cabinet is opened, or there is motion in the monitored area.

You can also set a reminder in case you forget to close the monitored object. You can choose to receive an alert once again if it remains open after 15, 30, or 60 minutes.

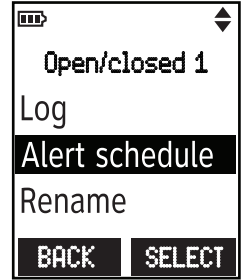

1. Press **SENSORS** on the handset or telephone base when idle, and then press \vee or \wedge on the handset, or **CALLER ID / \blacktriangledown** or **PHONEBOOK / \blacktriangle** on the telephone base to scroll to the desired sensor.
-OR-
 - i. Press **MENU** when the phone is not in use.
 - ii. Press \vee or \wedge on the handset, or **CALLER ID / \blacktriangledown** or **PHONEBOOK / \blacktriangle** on the telephone base to scroll to **Sensors**, and then press **SELECT**.
 - iii. Press \vee or \wedge on the handset, or **CALLER ID / \blacktriangledown** or **PHONEBOOK / \blacktriangle** on the telephone base to scroll to the desired sensor, and then press **SELECT**.
2. Press **OPTIONS** to enter the individual sensor menu.
3. Scroll to choose **Alert schedule**, and then press **SELECT**.
4. Press **SELECT** to select **Always on**. The reminder menu appears.
5. Scroll to choose **Off**, **15 minutes**, **30 minutes**, or **60 minutes**, and then press **SELECT** to save.

NOTES

- When you received the alert tone and announcement, the handset will display **Sensor X is open** or **Motion X detected motion**, whilst the telephone base will display **Sensor X is open** or **Motion X sensor detected motion**.
- For garage door sensor and open/closed sensor, both the handset and telephone base will also display ****, and the **SENSOR** light on the telephone base will turn red.

* **Sensor X** or **Motion X** refer to the sensor's name.

X refers to the system-assigned number of the sensor. You can edit the sensor's name to your preferred name. See **Rename the sensor** on page 43.

Set a time range for alerts

You can choose to receive an announcement alert - “*Sensor X is open*” or “*Motion X sensor detected motion*”, when a monitored garage door, in-house door, window, or medicine cabinet is opened, or when there is motion in the monitored area, during a preset time period of the day. For example, you can set to receive alert only from 10pm to 6am during bedtime.

You can also set a reminder in case you forget to close the monitored object. You can also choose to receive an alert once again if it remains open after 15, 30, or 60 minutes.

1. Press **SENSORS** on the handset or telephone base when idle, and then press \vee or \wedge on the handset, or **CALLER ID / \blacktriangledown** or **PHONEBOOK / \blacktriangle** on the telephone base to scroll to the desired sensor.
-OR-
 - i. Press **MENU** when the phone is not in use.
 - ii. Press \vee or \wedge on the handset, or **CALLER ID / \blacktriangledown** or **PHONEBOOK / \blacktriangle** on the telephone base to scroll to **Sensors**, and then press **SELECT**.
 - iii. Press \vee or \wedge on the handset, or **CALLER ID / \blacktriangledown** or **PHONEBOOK / \blacktriangle** on the telephone base to scroll to the desired sensor, and then press **SELECT**.
2. Press **OPTIONS** to enter the individual sensor menu.
3. Press \vee or \wedge on the handset, or **CALLER ID / \blacktriangledown** or **PHONEBOOK / \blacktriangle** on the telephone base to scroll to choose **Alert schedule**, and then press **SELECT**.
4. Press \vee or \wedge on the handset, or **CALLER ID / \blacktriangledown** or **PHONEBOOK / \blacktriangle** on the telephone base to scroll to choose **Time range**, and then press **SELECT**.
 - If time range has been set previously, press **EDIT** to edit.
5. Use the dialing keys (**0-9**) to enter the hour and minute for the start time. Scroll to choose **AM** or **PM**, and then press **NEXT**.
6. Use the dialing keys (**0-9**) to enter the hour and minute for the end time. Scroll to choose **AM** or **PM**, and then press **SAVE**. The reminder menu appears.
7. Scroll to choose **Off**, **15 minutes**, **30 minutes**, or **60 minutes**, and then press **SELECT** to save.

NOTE

- Suppose you have set the time range from 10pm to 6am. When the time reaches 10pm, you will receive the alert once if the garage door, in-house door, window, or medicine cabinet is already open.

Turn off the alerts

You can choose not to receive an announcement alert when a monitored garage door, in-house door, window, or medicine cabinet is opened, or when there is motion in the monitored area.

If it is a monitored garage door, in-house door, window, or medicine cabinet that is opened, the  icon will still display on the handset and telephone base. The **SENSOR** light on the telephone base will also turn on.

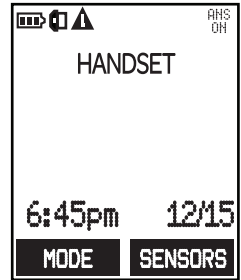

1. Press **SENSORS** on the handset or telephone base when idle, and then press \vee or \wedge on the handset, or **CALLER ID / \vee** or **PHONEBOOK/ \blacktriangle** on the telephone base to scroll to the desired sensor.
-OR-
 - i. Press **MENU** when the phone is not in use.
 - ii. Press \vee or \wedge on the handset, or **CALLER ID / \vee** or **PHONEBOOK/ \blacktriangle** on the telephone base to scroll to **Sensors**, and then press **SELECT**.
 - iii. Press \vee or \wedge on the handset, or **CALLER ID / \vee** or **PHONEBOOK/ \blacktriangle** on the telephone base to scroll to the desired sensor, and then press **SELECT**.
2. Press **OPTIONS** to enter the individual sensor menu.
3. Press \vee or \wedge on the handset, or **CALLER ID / \vee** or **PHONEBOOK/ \blacktriangle** on the telephone base to scroll to choose **Alert schedule**, and then press **SELECT**.
4. Press \vee or \wedge on the handset, or **CALLER ID / \vee** or **PHONEBOOK/ \blacktriangle** on the telephone base to scroll to choose **Off**, and then press **SELECT** to save.

Alert notifications

You can choose the type of notification to receive when a sensor is triggered. The preset alert notification type is **LCD, tone, voice**.

Definitions of notification types:

Msg - The LCD display messages, **Sensor X is open** or **Motion X detected motion**, on the handset and telephone base.

Tone - The long alert tone that you will hear prior to the voice announcement and LCD display message.

Voice - The voice announcement, “*Sensor X is open*” or “*Motion X sensor detected motion*”, at the handset and telephone base.

Notification type	Alert tone	Voice announcement	LCD display message	 *	SENSOR light on base*	Event logged in sensor log
LCD, tone, voice	✓	✓	✓	✓	✓	✓
LCD & tone	✓	--	✓	✓	✓	✓
LCD msg only	--	--	✓	✓	✓	✓

1. Press **MENU** on the handset or telephone base when idle.
2. Press \downarrow or \uparrow on the handset, or **CALLER ID / \blacktriangledown** or **PHONEBOOK/ \blacktriangle** on the telephone base to scroll to **Sensor setup**, and then press **SELECT**.
3. Press **SELECT** to select **Notifications**, and then press **SELECT**.
4. Press \downarrow or \uparrow on the handset, or **CALLER ID / \blacktriangledown** or **PHONEBOOK/ \blacktriangle** on the telephone base to scroll to choose **LCD, tone, voice**, **LCD & tone** or **LCD Msg only**, and then press **SELECT** to save.

NOTE

- If the alert schedule of a sensor is set to **Off**, when the monitored garage door, in-house door, window, or medicine cabinet is opened, there will be no notifications except that the  icon will display on the handset and telephone base, and the **SENSOR** light on the telephone base will turn on.

* **Q** and **SENSOR** light on the telephone base will not be displayed when motion sensor is triggered.

Test sensor signal strength

Before you mount the sensor, follow the instructions below to check the signal strength between the sensor and the telephone base. Make sure you mount the sensor in a location where the signal strength is good.

Using a handset:

1. Press **MENU** on the handset when idle.
2. Press **∨** or **∧** on the handset, or **CALLER ID / ▼** or **PHONEBOOK / ▲** on the telephone base to scroll to **Sensor setup**, and then press **SELECT**.
3. Press **∨** or **∧** on the handset, or **CALLER ID / ▼** or **PHONEBOOK / ▲** on the telephone base to scroll to **Check signal**, and then press **SELECT**.
4. Press **∨** or **∧** on the handset, or **CALLER ID / ▼** or **PHONEBOOK / ▲** on the telephone base to scroll to the sensor you want to test, and then press **SELECT**.
5. The screen displays **Test signal strength between base and sensor**. Press **NEXT**.
6. The screen displays **Please trigger your sensor now..** Trigger your sensor (refer to **Installation Guide**), and then press **NEXT**. The screen displays **Awaiting signal... Please wait.**
 - If the screen displays **No signal. Please try again..** Press **OK**, and then return to step 3 to test again.
 - If the screen displays **Weak signal Move sensor closer to base.,** adjust the sensor's location to improve the signal, and then press **NEXT**.
7. When the screen displays **Good signal. Good location for sensor..** Press **OK**.

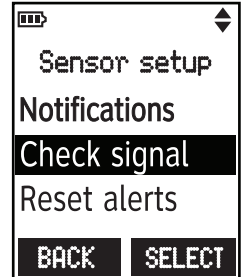

The testing is complete.

Rename the sensor

You can create a customized name of up to 15 characters for each sensor. The new name will also be announced in announcement alerts.

1. Press **SENSORS** on the handset or telephone base when idle, and then press **∨** or **∧** on the handset, or **CALLER ID / ∨** or **PHONEBOOK / ▲** on the telephone base to scroll to the desired sensor.
-OR-
 - i. Press **MENU** when the phone is not in use.
 - ii. Press **∨** or **∧** on the handset, or **CALLER ID / ∨** or **PHONEBOOK / ▲** on the telephone base to scroll to **Sensors**, and then press **SELECT**.
 - iii. Press **∨** or **∧** on the handset, or **CALLER ID / ∨** or **PHONEBOOK / ▲** on the telephone base to scroll to the desired sensor, and then press **SELECT**.
2. Press **OPTIONS** to enter the individual sensor menu.
3. Press **∨** or **∧** on the handset, or **CALLER ID / ∨** or **PHONEBOOK / ▲** on the telephone base to scroll to **Rename**, and then press **SELECT**.
4. Use the dialing keys to edit the name, and then press **SAVE** to save.

Reset sensor alerts

You can reset the alert schedule of all individual sensors' to their default settings - **Always on**. The sensor notification type will also be reset to its default setting - **Msg, tone, voice**.

1. Press **MENU** on the handset or telephone base when idle.
2. Press **∨** or **∧** on the handset, or **CALLER ID / ∨** or **PHONEBOOK / ▲** on the telephone base to scroll to **Sensor setup**, and then press **SELECT**.
3. Press **∨** or **∧** on the handset, or **CALLER ID / ∨** or **PHONEBOOK / ▲** on the telephone base to scroll to **Reset alerts**, and then press **SELECT**.
4. The screen displays **Reset all sensor alert settings to Always on?**. Press **YES**.
5. The screen displays **All sensors alerts are set to always on**, and then will return to the previous screen.

NOTES

- If you have renamed the sensor(s), the name(s) will not be reset to default.
- The current sensor mode will remain unchanged after reset.

Sensor log

The sensor log menu appears when there is at least one sensor registered to the telephone base.

The sensor log stores a maximum of 50 entries for the sensor activities from all sensors.

1. Press **MENU** on the handset or telephone base when idle.
2. Press \downarrow or \uparrow on the handset, or **CALLER ID / \downarrow** or **PHONEBOOK / \uparrow** on the telephone base to scroll to **Sensor log**, and then press **SELECT** to review the sensor log.
 - To delete a sensor log entry, press **DELETE**.
 - To delete all sensor log entries, press **DEL ALL**, and then **YES** to confirm. The screen will display **No alerts**.

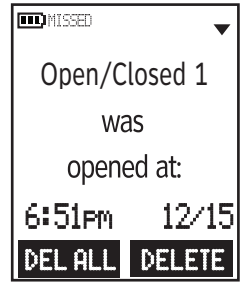

Individual sensor's log:

You can also access each individual sensor's log for the sensor activities of a single sensor.

1. Press **SENSORS** on the handset or telephone base when idle, and then press \downarrow or \uparrow on the handset, or **CALLER ID / \downarrow** or **PHONEBOOK / \uparrow** on the telephone base to scroll to the desired sensor.
-OR-
 - i. Press **MENU** on the handset or telephone base when idle.
 - ii. Press \downarrow or \uparrow on the handset, or **CALLER ID / \downarrow** or **PHONEBOOK / \uparrow** on the telephone base to scroll to **Sensors**, and then press **SELECT**.
 - iii. Press \downarrow or \uparrow on the handset, or **CALLER ID / \downarrow** or **PHONEBOOK / \uparrow** on the telephone base to scroll to the desired sensor, and then press **SELECT**.
2. Press **OPTIONS** to enter the individual sensor menu.
3. Press **SELECT** to select **Log** to review the sensor log.
 - To delete a sensor log entry, press **DELETE**.
 - To view the next sensor log entry, press **NEXT**.

Configure your telephone

Using the menus

1. Press **MENU** on the handset or telephone base when idle.
2. Press \downarrow or \uparrow on the handset, or **CALLER ID / \blacktriangledown** or **PHONEBOOK/ \blacktriangle** on the telephone base to scroll until the screen displays the desired feature menu.
3. Press **SELECT** to enter that menu.
 - To return to the previous menu, press **CANCEL**.
 - To return to idle mode, press and hold **CANCEL**.



Set language

The LCD language is preset to English. You can select English, French, or Spanish to be used in all screen displays.

1. Press **MENU** on the handset or telephone base when idle.
2. Press \downarrow or \uparrow on the handset, or **CALLER ID / \blacktriangledown** or **PHONEBOOK/ \blacktriangle** on the telephone base to scroll to **Phone setup**, then press **SELECT**.
3. Press **SELECT** to select **LCD language**.
4. Press \downarrow or \uparrow on the handset, or **CALLER ID / \blacktriangledown** or **PHONEBOOK/ \blacktriangle** on the telephone base to scroll to highlight **English**, **Français**, or **Español**, then press **SELECT**. The screen prompts **Set English/Français/Español as LCD language?**.
5. Press **YES** to save your preference.
-OR-
Press **NO** to cancel the operation.

NOTE

- If you accidentally changed the LCD language to French or Spanish, you can reset it to English easily by pressing **MENU** and then entering ***364#**.

Set date and time

NOTE

- Make sure you set the date and time including the year correctly; otherwise the answering system does not announce the correct day of the week for your recorded messages time stamp.
1. Press **MENU** on the handset or telephone base when idle.
 2. Press \vee or \wedge on the handset, or **CALLER ID** / \blacktriangledown or **PHONEBOOK** / \blacktriangle on the telephone base to scroll to **Set date/time**, and then press **SELECT**.
 3. Use the dialing keys (**0-9**) to enter the month, date, and year, and then press **NEXT**.
 4. Use the dialing keys (**0-9**) to enter the hour and minute. Press \vee or \wedge on the handset, or **CALLER ID** / \blacktriangledown or **PHONEBOOK** / \blacktriangle on the telephone base to scroll to choose **AM** or **PM**, and then press **SAVE** to save.

Temporary tone dialing

If you have pulse (rotary) service only, you can switch from pulse to tone dialing temporarily during a call.

1. During a call, press \star _{tone}.
2. Use the dialing keys to enter the relevant number.

The telephone sends touch-tone signals. It automatically returns to pulse dialing mode after you end the call.

Quiet mode

You can turn on the quiet mode for a period of time. During this period, all tones (except paging tone) and call screening are muted. When you turn on the quiet mode, the answering system turns on automatically.

1. Press and hold $\#$ _{quiet} on the handset or telephone base when idle.
2. Use the dialing keys (**0-9**) to enter the duration, and then press **SELECT** to save.



NOTES

- To turn off the quiet mode, press and hold $\#$ _{quiet} on the handset or telephone base when idle.
- Sensor alert tone and announced alert will not be silenced in quiet mode.

Caller ID announce

The caller ID announce feature lets you know who's calling without having to look at the display. When you have an incoming call, the handset speaks "Call from..." and the name of the caller based on the phonebook or caller ID information. If the caller's name is private or unknown, the phone number up to the last 11 digits will be announced. If the caller's phone number is also private or unknown, no information will be announced.

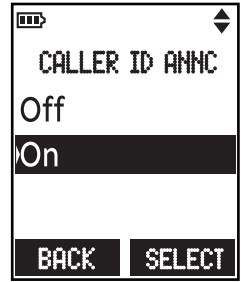

1. Press **MENU** on the handset or telephone base when idle.
2. Press \vee or \wedge on the handset, or **CALLER ID / \blacktriangledown** or **PHONEBOOK / \blacktriangle** on the telephone base to scroll to **Caller ID annc**, and then press **SELECT**.
3. Press \vee or \wedge on the handset, or **CALLER ID / \blacktriangledown** or **PHONEBOOK / \blacktriangle** on the telephone base to scroll to choose **On** or **Off**, and then press **SELECT** to save.

NOTES

- To use the caller ID announce feature, you must subscribe to caller ID service from your telephone service provider.
- When there are more than four handsets registered, the telephone system supports caller ID announce for the first four registered handsets only.
- This feature does not announce information for call waiting calls.
- It takes at least 2 rings for the phone to receive caller ID information and announce it. If the phone is answered before the end of the second ring, the phone won't have time to announce the caller's information.
- Pronunciation of names may vary with this feature. Not all names may be pronounced correctly.
- When this feature is on, the telephone plays both the caller ID information and the ringer at the same time when there is an incoming call. Caller ID announce is available in English only.

Use caller ID to automatically set date and time

If you subscribe to caller ID service, the month, day, and time are set automatically with each incoming call. Follow the steps below to turn the **CID time sync** feature on or off. The default setting is **On**.

1. Press **MENU** in idle mode to enter the main menu.
2. Press \vee or \wedge on the handset, or **CALLER ID / \blacktriangledown** or **PHONEBOOK / \blacktriangle** on the telephone base to scroll to **Phone setup**, then press **SELECT**.
3. Press \vee or \wedge on the handset, or **CALLER ID / \blacktriangledown** or **PHONEBOOK / \blacktriangle** on the telephone base to scroll to **CID time sync**, then press **SELECT**.
4. Press \vee or \wedge on the handset, or **CALLER ID / \blacktriangledown** or **PHONEBOOK / \blacktriangle** on the telephone base to scroll to highlight **On** or **Off**, then press **SELECT** to save. There is a confirmation tone and the screen returns to the previous menu.

Home area code

If you dial your local calls using only seven digits (area code not required), you can program your home area code so that when you receive a call within your local area, the telephone number is automatically stored without the area code in the caller ID log.

1. Press **MENU** on the handset or telephone base when idle.
2. Press \downarrow or \uparrow on the handset, or **CALLER ID / \blacktriangledown** or **PHONEBOOK / \blacktriangle** on the telephone base to scroll to **Phonebook**, and then press **SELECT**.
3. Press **OPTION** to choose **Home**.
4. Press \downarrow or \uparrow on the handset to scroll to **Home areacode**, then press **SELECT**. The screen briefly shows **Only for 7 digit dial from CID**.

-OR-

Press **CALLER ID / \blacktriangledown** or **PHONEBOOK / \blacktriangle** on the telephone base to scroll to **Home area code**, then press **SELECT**. The screen briefly shows **Only for 7 digits dialing from Caller ID log**.

5. Use the dialing keys to enter a three-digit home area code.
 - Press **MUTE/DELETE** on the handset, or **X/DELETE** on the telephone base to erase a digit.
 - Press and hold **MUTE/DELETE** on the handset, or **X/DELETE** on the telephone base to erase all digits.
6. Press **SAVE** to confirm. There is a confirmation tone. The handset screen shows **Areacode will not show in CID** and the telephone base screen shows **Area code will not show in Caller ID log** briefly before returning to the previous menu.

NOTE

If, in the future, your telephone service provider requires you to dial the area code when making a local call, or, if you move to a location that requires it, delete the home area code you have already programmed, following the steps above. After you have deleted the home area code, **_ _ _** will appear on the display.



Dial mode

The dial mode is preset to touch-tone dialing. If you have pulse (rotary) service, you must change the dial mode to pulse dialing before using the telephone to make a call.



1. Press **MENU** on the handset or telephone base when idle.
2. Press \downarrow or \uparrow on the handset, or **CALLER ID / \blacktriangledown** or **PHONEBOOK / \blacktriangle** on the telephone base to scroll to **Phone setup**, then press **SELECT**.
3. Press \downarrow or \uparrow on the handset, or **CALLER ID / \blacktriangledown** or **PHONEBOOK / \blacktriangle** on the telephone base to scroll to **Dial mode**, then press **SELECT**.
4. Press \downarrow or \uparrow on the handset, or **CALLER ID / \blacktriangledown** or **PHONEBOOK / \blacktriangle** on the telephone base to scroll to **Touch-tone** or **Pulse**, then press **SELECT**. There is a confirmation tone and the screen returns to the previous menu.

Telephone operations

Make a call

1. Press  or  on the handset, or press  on the base.
2. When you hear a dial tone, dial the number.

-OR-

- Enter the telephone number on the handset or base, and then press  or  on the handset, or press  on the base, to dial.

NOTES

- The handset or telephone base shows the elapsed time as you talk (in hours, minutes and seconds).
- While entering numbers, press and hold **PAUSE** to insert a dialing pause (a **p** appears).

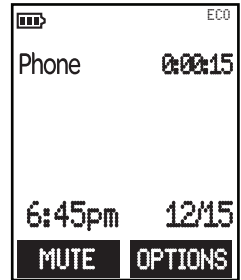

Answer a call

- Press  or  on the handset,  on the base, or any dialing key (**0-9**, or ***tone**).

End a call

- Press **OFF** on the handset, or put the handset to the base or charger.





-OR-

- Press  on the base.

Handset speakerphone

- During a call, press  on the handset to switch between speakerphone and normal handset use.

Volume

- During a call on the handset, press /VOLUME/ to adjust the listening volume.
- During a call on the telephone base, press /VOL/ to adjust the listening volume.

NOTE

- The volume settings of handset earpiece, handset speakerphone, and telephone base speakerphone are independent.

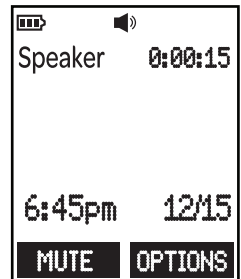

Mute

The mute function allows you to hear the other party but the other party cannot hear you.

1. During a call, press **MUTE** on the handset or telephone base. The screen displays **Muted** until the mute function is turned off.
2. Press **MUTE** again to resume the conversation. The screen briefly displays **Microphone ON**.

Call waiting

When you subscribe to call waiting service from your telephone service provider, you hear an alert tone if there is an incoming call while you are on another call.

- Press **FLASH** to put the current call on hold and take the new call.
- Press **FLASH** to switch back and forth between calls.

Find handset

Use this feature to find all system handsets.

To start paging:

- Press **FIND HANDSET** on the base. All idle handsets ring and display **** Paging ****.

To mute paging:

- Press **MUTE**, **MUTE**, **CANCEL**, or **#quiet** on the handset.

To end paging:

- Press **FIND HANDSET** or **STOP** on the base.

-OR-

- Press **TALK**, **FLASH**, or any dialing key on the handset.

NOTE



- Do not press and hold **FIND HANDSET** for more than four seconds. It may lead to handset deregistration.



Redial list

The base and each handset store the last 10 telephone numbers dialed. When there are already 10 entries, the oldest entry is deleted to make room for the new entry.

To review and dial a number from the redial list:



1. Press **REDIAL** on the handset or telephone base when idle.
2. Press \vee or \wedge on the handset, or **CALLER ID / \blacktriangledown** or **PHONEBOOK / \blacktriangle** on the telephone base to scroll or press **REDIAL** repeatedly until the desired entry displays.
3. Press  or  on the handset, or press  on the base, to dial.

To delete a redial entry:

When the desired redial entry displays, press **DELETE**.

Join a call in progress

You can use up to two handsets plus the base at a time on a call. You can buy additional expansion handsets for this telephone base. You can register up to 5 handsets to the telephone base.

- When a handset is on a call, press  or  on another handset to join the call.
- Press **OFF** on the handset or  on the base to exit the call. The call continues until all handsets hang up.

Push-to-talk (PTT)

You can directly broadcast messages from one handset to the speakerphone of one or multiple handsets. Up to four handsets can join in a PTT call.

To start a PTT communication:



1. Press **PUSH TO TALK** on the handset or **PTT** on the base when idle.
2. Scroll to a desired device or **Group**, and then press **SELECT**.

NOTES

- Only one device can talk at a time.
- Press and hold **PUSH TO TALK** while you are talking. Release **PUSH TO TALK** to let the other party respond.
- When there are 5 devices on the PTT at the same time, you will not receive any voice announcement alert from sensors.

Intercom

Use the intercom features for conversations between the telephone base and handsets.

1. Press **MENU** on the handset or telephone base when idle.
2. Scroll to **Intercom** and then press **SELECT**.
3. Use the dialing keys to enter a destination handset or base number.
4. To answer the intercom call, press , , or **ANSWER** on the handset; or  or **ANSWER** on the base; or any dialing key on the destination handset or base.
5. To end the intercom call, press **END**.

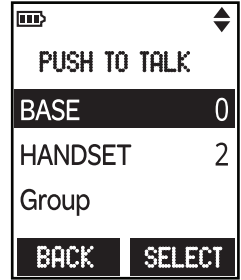



NOTE

- When there are 5 devices on intercom at the same time, you will not receive any voice announcement alert from sensors.

Transfer a call



While on an outside call, you can use the intercom feature to transfer the call from one handset to another.

1. Press **OPTIONS** on the handset or telephone base during a call.
2. Press **SELECT** to choose **Intercom**. Use the dialing keys to enter a destination device number. The current call is put on hold.
3. To answer the intercom call, press , , or **ANSWER** on the handset; or  or **ANSWER** on the base; or any dialing key on the destination device. You can now have a private conversation before transferring the call.
4. To transfer the call, press **OPTIONS** on the initiating device, and then press **SELECT** to select **Transfer**.



Answer an incoming call during an intercom call

If you receive an incoming call during an intercom call, there is an alert tone.

- To answer a call, press  or  on the handset, or press  on the base. The intercom call ends automatically.
- To end the intercom call without answering the outside call, press **BACK** and then **END**. The intercom call ends and the telephone continues to ring.

Phonebook

The phonebook stores up to 50 entries with up to 30 digits for each phone number and 15 characters for each name.

Add a phonebook entry

1. Press **MENU** on the handset or telephone base when idle.
2. Press \downarrow or \uparrow on the handset, or **CALLER ID / \blacktriangledown** or **PHONEBOOK / \blacktriangle** on the telephone base to scroll to **Phonebook**, and then press **SELECT**.
3. Press \downarrow or \uparrow on the handset, or **CALLER ID / \blacktriangledown** or **PHONEBOOK / \blacktriangle** on the telephone base to scroll to **Add contact**, and then press **SELECT**.
4. Use the dialing keys to enter the number (up to 30 digits), and then press **NEXT**.
5. Use the dialing keys to enter the name (up to 15 characters). Additional key presses show other characters of that particular key.
6. Press **SAVE** to save.

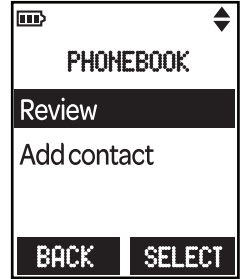

While entering numbers and names, you can:

- Press **DELETE** to erase a digit or character.
- Press and hold **DELETE** to erase the entire entry.
- Press \downarrow or \uparrow on the handset, or **CALLER ID / \blacktriangledown** or **PHONEBOOK / \blacktriangle** on the telephone base to scroll to move the cursor to the left or right.
- Press and hold **PAUSE** to insert a dialing pause (for entering phone numbers only).
- Press **0** to add a space (for entering names only).
- Press \star_{tone} to add \star or $\#$ to add $\#$ (for entering phone numbers only).
- Press \star_{tone} to change the next letter to upper or lower case.

Review and dial from the phonebook

Entries are sorted alphabetically.

1. Press \heartsuit on the handset or **PHONEBOOK / \blacktriangle** on the telephone base when idle.
2. Press \downarrow or \uparrow on the handset, or **CALLER ID / \blacktriangledown** or **PHONEBOOK / \blacktriangle** on the telephone base to scroll to browse through the phonebook, or use the dialing keys to start a name search.
3. When the desired entry appears, Press PHONE or CALL on the handset, or press SPEAKER on the base to dial.



Edit a phonebook entry

1. When the desired entry displays, press **EDIT**.
2. Use the dialing keys and **BACKSP** to edit the number, and then press **NEXT**.
3. Use the dialing keys to edit the name, and then press **SAVE** to save.

Delete a phonebook entry

1. When the desired entry displays, press **DELETE**.
2. When the screen displays **Delete contact?**, press **YES** to confirm delete.

Caller ID

This product supports caller ID services provided by most telephone service providers. Depending on your service subscription, you may see the caller's name, number, date and time of calls that are sent by your telephone service provider after the first or second ring.

Caller ID log

The caller ID log stores up to 50 entries. If you answer a call before the caller information appears, it will not be saved in the caller ID log.

- The screens display **XX Missed calls** when there are new missed calls in the caller ID log.
- If you want to erase the missed call indicator, press and hold CANCEL or press **CID** when idle.

Review and dial a number in the caller ID log

1. Press **CID** or **CALLER ID/▼** when idle.
2. Press **▼** or **▲** on the handset, or **CALLER ID /▼** or **PHONEBOOK /▲** on the telephone base to scroll to browse through the caller ID log. When the desired entry appears:
 - Press **#** repeatedly to show different dialing options.
 - Press **1** repeatedly if you need to add or remove 1 in front of the phone number.
3. Press **CALL** or **▶** on the handset, or press **▶** on the base to dial the displayed number.

Save a caller ID log entry to the phonebook

1. When the desired caller ID log entry displays, press **SAVE**.
2. Press **SELECT** to select **Phonebook**.
3. Use the dialing keys and **BACKSP** to edit the number, and then press **NEXT**.
4. Use the dialing keys to edit the name, and then press **SAVE** to save.

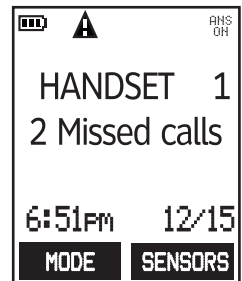

Delete a caller ID log entry

- When the desired caller ID log entry displays, press **DELETE**.

Delete all caller ID log entries

1. Press **MENU** on the handset or telephone base when idle.
2. Press **∨** or **∧** on the handset, or **CALLER ID /∇** or **PHONEBOOK /▲** on the telephone base to scroll to **Caller ID log** and then press **SELECT**.
3. Press **∨** or **∧** on the handset, or **CALLER ID /∇** or **PHONEBOOK /▲** on the telephone base to scroll to **Del all calls** and then press **SELECT**.
4. When the screen displays **Delete all calls?**, press **YES** to confirm delete.

Call block

If you subscribe to caller ID service, you can set the telephone to block unknown calls and certain undesired calls.

The call block list stores up to 20 entries.

Block unknown calls

1. Press **MENU** when the phone is not in use.
2. Press \downarrow or \uparrow on the handset, or **CALLER ID / \blacktriangledown** or **PHONEBOOK / \blacktriangle** on the telephone base to scroll to **Call block**, and then press **SELECT**.
3. Press \downarrow or \uparrow on the handset, or **CALLER ID / \blacktriangledown** or **PHONEBOOK / \blacktriangle** on the telephone base to scroll to **Calls w/o num**, and then press **SELECT**.
4. Press \downarrow or \uparrow on the handset, or **CALLER ID / \blacktriangledown** or **PHONEBOOK / \blacktriangle** on the telephone base to scroll to **Block** or **Unblock**, and then press **SELECT**.

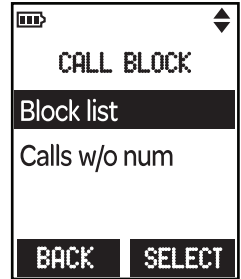

Add a call block list entry

1. Press **MENU** when the phone is not in use.
2. Press \downarrow or \uparrow on the handset, or **CALLER ID / \blacktriangledown** or **PHONEBOOK / \blacktriangle** on the telephone base to scroll to **Call block**, and then press **SELECT**.
3. Press **SELECT** to select **Block list**.
4. Press \downarrow or \uparrow on the handset, or **CALLER ID / \blacktriangledown** or **PHONEBOOK / \blacktriangle** on the telephone base to scroll to **Add new entry**, and then press **SELECT**.
5. Enter the number.
 - Use the dialing keys to enter the number (up to 30 digits).
6. Press **NEXT** to move to the name.
7. Use the dialing keys to enter the name (up to 15 characters). Additional key presses show other characters of that particular key.
8. Press **SAVE** to save.

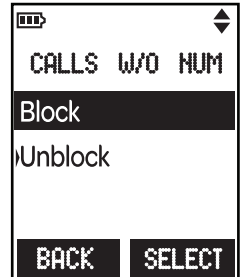

Review the call block list

1. Press **MENU** when the phone is not in use.
2. Press \downarrow or \uparrow on the handset, or **CALLER ID / \blacktriangledown** or **PHONEBOOK / \blacktriangle** on the telephone base to scroll to **Call block**, and then press **SELECT**.
3. Press **SELECT** to select **Block list**.
4. Press **SELECT** to choose **Review**.
5. Press \downarrow or \uparrow on the handset, or **CALLER ID / \blacktriangledown** or **PHONEBOOK / \blacktriangle** on the telephone base to browse through the call block list.

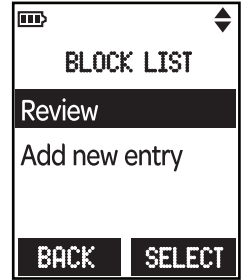

Edit a call block list entry

1. When the desired entry displays, press **EDIT**.
2. Use the dialing keys to edit the number, and then press **NEXT**.
3. Use the dialing keys to edit the name, and then press **SAVE** to save.

Save a caller ID log entry to call block list

1. When the desired caller ID log entry displays, press **SAVE**.
2. Press \downarrow or \uparrow on the handset, or **CALLER ID / \blacktriangledown** or **PHONEBOOK / \blacktriangle** on the telephone base to scroll to **Call block** then press **SELECT**.
3. Use the dialing keys and **BACKSP** to edit the number, and then press **NEXT**.
4. Use the dialing keys to edit the name, and then press **SAVE** to save.

Delete a call block list entry

1. When the desired call block list entry displays, press **DELETE**.
2. When the screen displays **Delete entry?**, press **YES** to confirm delete.

Sound settings

Key tone

You can adjust the key tone volume, or turn the key tone off.

1. Press **MENU** when the handset is not in use.
2. Press \downarrow or \uparrow on the handset, or **CALLER ID / \blacktriangledown** or **PHONEBOOK / \blacktriangle** on the telephone base to scroll to **Phone setup**, and then press **SELECT**.
3. Press \downarrow or \uparrow on the handset, or **CALLER ID / \blacktriangledown** or **PHONEBOOK / \blacktriangle** on the telephone base to scroll to choose **Key tone**, and then press **SELECT**.
4. Press \downarrow or \uparrow on the handset, or **CALLER ID / \blacktriangledown** or **PHONEBOOK / \blacktriangle** on the telephone base to scroll to choose the desired volume or **Off**, and then press **SET** to save.

Ringer tone

You can choose from different ringer tones.

1. Press **MENU** on the handset or telephone base when idle.
2. Press \downarrow or \uparrow on the handset, or **CALLER ID / \blacktriangledown** or **PHONEBOOK / \blacktriangle** on the telephone base to scroll to **Ringers**, and then press **SELECT**.
3. Press \downarrow or \uparrow on the handset, or **CALLER ID / \blacktriangledown** or **PHONEBOOK / \blacktriangle** on the telephone base to scroll to **Ringer tone**, and then press **SELECT**.
4. Press \downarrow or \uparrow on the handset, or **CALLER ID / \blacktriangledown** or **PHONEBOOK / \blacktriangle** on the telephone base to sample each ringer tone, and then press **SELECT** to save.

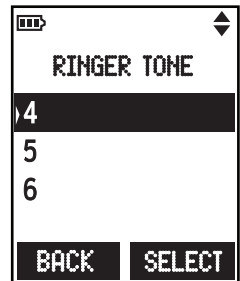

NOTE

- If you turn off the ringer volume, you will not hear ringer tone samples.

Ringer volume

You can adjust the ringer volume level, or turn the ringer off.

To adjust the handset ringer volume:

1. Press **MENU** on the handset when idle.
2. Press \downarrow or \uparrow on the handset, or **CALLER ID / \blacktriangledown** or **PHONEBOOK / \blacktriangle** on the telephone base to scroll to **Ringers**, and then press **SELECT**.
3. Press **SELECT** to select **Ringer volume**.
4. Press \downarrow or \uparrow on the handset, or **CALLER ID / \blacktriangledown** or **PHONEBOOK / \blacktriangle** on the telephone base to scroll to adjust the volume, and then press **SET** to save.

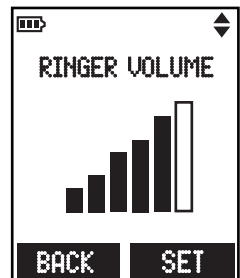

NOTE

- If the handset ringer volume is set to off, the handset is silenced for all incoming calls except paging tone.

To adjust the telephone base ringer volume:

Press **▲/VOL/▼** on the telephone base when idle.

Temporary ringer silencing

When the telephone is ringing, you can temporarily silence the ringer without disconnecting the call. The next call rings normally at the preset volume.

- Press **MUTE**, **MUTE**, **CANCEL**, or **#quiet** on the handset or telephone base. The screen displays .

About the built-in answering system and voicemail service

For message recording, your telephone has a built-in answering system, and it also support voicemail service offered by your telephone service provider (subscription is required, and fee may apply).

The main differences between them are as follows:

Category	Built-in answering system	Voicemail from telephone service
Storage	Messages are stored in the telephone base.	Messages are stored in a server or system provided by your telephone service.
	Your messages will not be deleted automatically. You have to delete your messages manually.	Your messages may be automatically deleted after a period of time. Contact your telephone service provider for more details.
Method to retrieve messages	When you received new messages, OO displays on both the handset and telephone base, XX New msgs displays on the handset, and XX New messages displays on the telephone base.	When you received new messages, the handset displays ☑ and New voicemail .
	To retrieve messages, usually there are two ways: <ul style="list-style-type: none"> • Press a button on the telephone base; or • Access remotely with an access code. 	To retrieve messages, you need an access number and/or a passcode provided by your telephone service provider.

Set your built-in answering system

Your answering system has various features, read below for the basic settings.

The answering system can record and store up to 99 messages. Each message can be up to three minutes in length. The total storage capacity for the announcement, messages and memos is approximately 22 minutes. The actual recording time depends on individual message characteristics.

Your answering system allows you to set your announcement, to save and delete messages, activate call screening, to set number of rings before pick up, to access remotely, and to control the recording time.

Turn the answering system on or off

The answering system must be turned on to answer and record messages.

Using the telephone base:

- Press **ANS ON/OFF** on the telephone base to turn the built-in answering system on or off.

-OR-

Using the telephone base or handset:

1. Press **MENU** when the phone is not in use.
2. Press **SELECT** to select **Answering sys.**
3. Press **▼** or **▲** on the handset, or **CALLER ID /▼** or **PHONEBOOK /▲** on the telephone base to scroll to highlight **Answer ON/OFF**, and then press **SELECT**.
4. Press **▼** or **▲** on the handset, or **CALLER ID /▼** or **PHONEBOOK /▲** on the telephone base to scroll to highlight **On** or **Off**, and then press **SELECT** to save. You hear a confirmation tone.



Default announcement

The telephone is preset with a greeting that answers calls with *"Hello, please leave a message after the tone."* You can use this preset announcement, or replace it with your own.

Record your own announcement

You can use the preset announcement to answer calls, or replace it with your own recorded announcement. It can be up to 90 seconds in length.

1. Press **MENU** on the handset or telephone base when idle.
2. Press \vee or \wedge on the handset, or **CALLER ID / \blacktriangledown** or **PHONEBOOK / \blacktriangle** on the telephone base to scroll to **Answering sys**, and then press **SELECT**.
3. Press **SELECT** to select **Announcement**.
4. Press **SELECT** to select **Record annc**.
5. The handset or telephone base announces *“Record after the tone. Press **STOP** when you are done.”* After the tone, speak towards the microphone. Press **STOP** when done.



Play the announcement

1. Press **MENU** on the handset or telephone base when idle.
2. Press \vee or \wedge on the handset, or **CALLER ID / \blacktriangledown** or **PHONEBOOK / \blacktriangle** on the telephone base to scroll to **Answering sys**, and then press **SELECT**.
3. Press **SELECT** to select **Announcement**.
4. Press \vee or \wedge on the handset, or **CALLER ID / \blacktriangledown** or **PHONEBOOK / \blacktriangle** on the telephone base to scroll to **Play annc** and then press **SELECT**.

Reset the announcement

1. Press **MENU** on the handset or telephone base when idle.
2. Press \vee or \wedge on the handset, or **CALLER ID / \blacktriangledown** or **PHONEBOOK / \blacktriangle** on the telephone base to scroll to **Answering sys**, and then press **SELECT**.
3. Press **SELECT** to select **Announcement**.
4. Press \vee or \wedge on the handset, or **CALLER ID / \blacktriangledown** or **PHONEBOOK / \blacktriangle** on the telephone base to scroll to **Reset annc** and then press **SELECT**.
5. Press **YES** to reset to the default announcement.

Set number of rings

You can set the answering system to answer an incoming call after 2, 3, 4, 5 or

6 rings; or toll saver. If you choose toll saver, the answering system answers after 2 rings when you have new messages, or after 4 rings when you have no new messages.

1. Press **MENU** on the handset or telephone base when idle.
2. Press \downarrow or \uparrow on the handset, or **CALLER ID / \blacktriangledown** or **PHONEBOOK / \blacktriangle** on the telephone base to scroll to **Answering sys**, and then press **SELECT**.
3. Press \downarrow or \uparrow on the handset, or **CALLER ID / \blacktriangledown** or **PHONEBOOK / \blacktriangle** on the telephone base to scroll to **Ans sys setup**, then press **SELECT**.
4. Press \downarrow or \uparrow on the handset, or **CALLER ID / \blacktriangledown** or **PHONEBOOK / \blacktriangle** on the telephone base to scroll to **# of rings**, then press **SELECT**.
5. Press \downarrow or \uparrow on the handset, or **CALLER ID / \blacktriangledown** or **PHONEBOOK / \blacktriangle** on the telephone base to scroll to choose **6, 5, 4, 3, 2** or **Toll saver**, and then press **SELECT**.

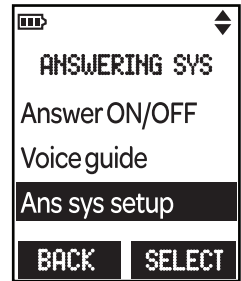

Message alert tone

When the message alert tone is set to on, and there is at least one new message, the telephone base beeps every 10 seconds. The message alert tone is preset to off.

1. Press **MENU** when the phone is not in use.
2. Press \downarrow or \uparrow on the handset, or **CALLER ID / \blacktriangledown** or **PHONEBOOK / \blacktriangle** on the telephone base to scroll to **Answering sys**, and then press **SELECT**.
3. Press \downarrow or \uparrow on the handset, or **CALLER ID / \blacktriangledown** or **PHONEBOOK / \blacktriangle** on the telephone base to scroll to **Ans sys setup**, then press **SELECT**.
4. Press \downarrow or \uparrow on the handset, or **CALLER ID / \blacktriangledown** or **PHONEBOOK / \blacktriangle** on the telephone base to scroll to **Msg alert tone**, then press **SELECT**.
5. Press \downarrow or \uparrow on the handset, or **CALLER ID / \blacktriangledown** or **PHONEBOOK / \blacktriangle** on the telephone base to scroll to choose **On** or **Off**.
6. Press **SELECT** to save and you hear a confirmation tone.

Recording time

You can set the recording time limit for each incoming message.

1. Press **MENU** when the phone is not in use.
2. Press \vee or \wedge on the handset, or **CALLER ID / \blacktriangledown** or **PHONEBOOK / \blacktriangle** on the telephone base to scroll to **Answering sys**, and then press **SELECT**.
3. Press \vee or \wedge on the handset, or **CALLER ID / \blacktriangledown** or **PHONEBOOK / \blacktriangle** on the telephone base to scroll to **Ans sys setup**, then press **SELECT**.
4. Press \vee or \wedge on the handset, or **CALLER ID / \blacktriangledown** or **PHONEBOOK / \blacktriangle** on the telephone base to scroll to **Recording time**, then press **SELECT**.
5. Press \vee or \wedge on the handset, or **CALLER ID / \blacktriangledown** or **PHONEBOOK / \blacktriangle** on the telephone base to scroll to choose **3 minutes**, **2 minutes** or **1 minute**.
6. Press **SELECT** to save and you hear a confirmation tone.

Voice guide

This feature is an alternative way for you to do the basic setup of the answering system. You can follow the voice guide to record your own announcement, set the number of rings and the message alert tone.

1. Press **MENU** when the phone is not in use.
2. Press \vee or \wedge on the handset, or **CALLER ID / \blacktriangledown** or **PHONEBOOK / \blacktriangle** on the telephone base to scroll to **Answering sys**, and then press **SELECT**.
3. Press \vee or \wedge on the handset, or **CALLER ID / \blacktriangledown** or **PHONEBOOK / \blacktriangle** on the telephone base to scroll to **Voice guide**, and then press **SELECT**. You hear the voice prompt *"Hello! This voice guide will assist you with the basic setup of your answering system."*
4. Setup your answering system by inputting designated numbers as instructed in the voice guide.

Use your built-in answering system

New message indication

When you received a message on your answering system, **OO** displays on both the handset and telephone base, **XX New msgs** displays on the handset, and **XX New messages** displays on the telephone base. To retrieve, press **▶/■/PLAY** when the phone is not in use.



Message playback

To play messages at the telephone base:

- Press **▶/■/PLAY** when the phone is not in use.

Options during playback:

- Press **▲/VOL/▼** to adjust the speaker volume.
- Press **▶/SKIP** to skip to the next message.
- Press **◀/REPEAT** to repeat the message currently playing.
Press **◀/REPEAT** twice to listen to the previous message.
- Press **X/DELETE** to delete the playing message. The system advances to the next message.
- Press **▶/■/STOP** to stop.
- Press **☎/CALLER ID** to call back the caller if the message contains caller ID information. The telephone base screen displays **Call back?** with the caller ID information.
 - Press **CALL** to call back the caller.
 - Press **BACK** to restart the message playback.



To play messages at the handset:

1. Press **MENU** when the handset is not in use.
2. Press **▼** or **▲** on the handset, or **CALLER ID /▼** or **PHONEBOOK /▲** on the telephone base to scroll to **Play messages**, and then press **SELECT**.
 - If there are new and old messages, press **▼** or **▲** to select **Play new msgs** or **Play old msgs**, then press **SELECT**.
 - If there are only new or only old messages, they will play automatically.

The system announces the number of messages, then begins playback. The message sequence is shown on the handset. If there are no recorded messages, the handset shows **No messages** and you hear, “You have no messages.”

Options during playback:

- Press **VOLUME/** or **VOLUME/** to adjust the message playback volume.
- Press **SKIP** to skip to the next message.
- Press **REPEAT** to repeat the message. Press **REPEAT** twice to listen to the previous message.
- Press **DELETE** to delete the message.
- Press  to call back the caller if the message contains caller ID information. The telephone base screen displays **Call back?** with the caller ID information.
 - Press **CALL** to call back the caller.
 - Press **BACK** to restart the message playback.

NOTES

- Only one handset or the telephone base can access the answering system at a time.
- During message playback, if there is an incoming call or another handset makes a call, message playback will be stopped.

Delete all old messages



To delete all old messages at the telephone base:

Press **X/DELETE** twice when the phone is not in use.

To delete all old messages on a handset:

1. Press **MENU** when the phone is not in use.
2. Press **∨** or **∧** on the handset, or **CALLER ID /∇** or **PHONEBOOK /▲** on the telephone base to scroll to **Answering sys**, and then press **SELECT**.
3. Press **∨** or **∧** on the handset, or **CALLER ID /∇** or **PHONEBOOK /▲** on the telephone base to scroll to **Delete all old**, and then press **SELECT**.
4. Press **YES** to confirm delete. You hear a confirmation tone.

Call intercept

If you want to talk to the person whose message is being recorded, press  or  on the handset, or press  on the base.

Remote access

A two-digit security code is required to access the messages, or change the sensor mode setting remotely, from any touch-tone telephone. The preset code is **19**. You can use this preset code, or set your own.

1. Dial your telephone number from any touch-tone telephone.
2. When the system plays your announcement, enter the two-digit security code.
3. Enter the one of the remote commands, # or *, to listen to message or change the sensor mode.

Command	Description
#	To listen to messages (see page 68).
*	To change the sensor mode (see page 69).

Listen to messages from remote access

1. Follow steps 1 and 2 in **Remote access** section on page 68 to enter remote access mode.
2. Press # on your remote touch-tone telephone to enter the answering system operations command session.
3. You can enter one of the following remote commands to do the answering system operations.

Command	Description
1	Play all messages.
2	Play new messages.
3	Delete the current message (during playback).
33	Delete all old messages.
4	Repeat the current message (during playback).
5	Stop.
*5	Hear a list of remote commands.
6	Skip to the next message (during playback).
*7	Record a new announcement.
8	End the call.
0	Turn the answering system on or off.

4. Hang up or press **8** to end the call.

Change sensor mode from remote access

1. Follow steps 1 and 2 in **Remote access** section on page 68 to enter remote access mode.
2. Press * on your remote touch-tone telephone to enter the sensor mode command session.
3. You can enter one of the following remote commands to change to the respective sensor mode.

Command	Description
1	Change to Local mode.
2	Change to Remote mode.
3	Turn off all alerts in local mode.

NOTE

- Changing the sensor mode in remote access from **Local** to **Remote**, or vice versa, will automatically set the sensor alert system to be **Armed**.

Remote access code

A two-digit security code is required to access the answering system remotely from any touch-tone telephone. The preset code is **19**. You can set the code from **00** to **99**.

1. Press **MENU** when the phone is not in use.
2. Press \vee or \wedge on the handset, or **CALLER ID** / \blacktriangledown or **PHONEBOOK** / \blacktriangle to scroll to **Answering sys**, and then press **SELECT**.
3. Press \vee or \wedge on the handset, or **CALLER ID** / \blacktriangledown or **PHONEBOOK** / \blacktriangle to scroll to **Ans sys setup**, then press **SELECT**.
4. Press \vee or \wedge on the handset, or **CALLER ID** / \blacktriangledown or **PHONEBOOK** / \blacktriangle to scroll to **Remote code**, and then press **SELECT**.
5. Use the dialing keys to enter a two-digit number.
6. Press **SAVE** to save and you hear a confirmation tone.

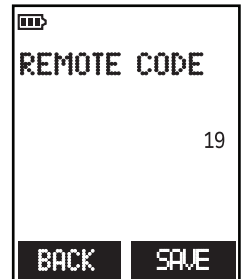

Use the built-in answering system and voicemail service

You can use your answering system and voicemail service together by setting your answering system to answer before voicemail service answers as described below. To learn how to program your voicemail settings, contact your telephone service provider.

If you are on a call, or if the answering system is busy recording a message and you receive another call, the second caller can leave a voicemail message.

Set your answering system to answer calls at least two rings earlier than your voicemail service is set to answer. For example, if your voicemail service answers after six rings, set your answering system to answer after four rings.

Some voicemail service providers may program the delay before answering calls in seconds instead of rings. In this case, allow six seconds per ring when determining the appropriate setting.

Retrieve voicemail from telephone service

Retrieve voicemail

When you received a voicemail, the handset displays  and **New voicemail**. To retrieve, you typically dial an access number provided by your telephone service provider, and then enter a security code. Contact your telephone service provider for instructions on how to configure the voicemail settings and listen to messages.

NOTE

- After you have listened to all new voicemail messages, the indicators on the handset turn off automatically.

Set your voicemail number

You can save your access number on each handset for easy access to your voicemail.

After you saved the voicemail number, you can press and hold 1 to retrieve voicemail.

1. Press **MENU** when the handset is not in use.
2. Press \downarrow or \uparrow on the handset, or **CALLER ID / \blacktriangledown** or **PHONEBOOK / \blacktriangle** to scroll to **Phone setup**, and then press **SELECT**.
3. Press \downarrow or \uparrow on the handset, or **CALLER ID / \blacktriangledown** or **PHONEBOOK / \blacktriangle** to scroll to **Voicemail #**, and then press **SELECT**.
4. Use the dialing keys to enter the voicemail number (up to 30 digits).
5. Press **SAVE** to save.



Turn off the new voicemail indicators

If you have retrieved your voicemail while away from home, and the handset still displays the new voicemail indicators, use this feature to turn off the indicators.

NOTE

- This feature turns off the indicators only, it does not delete your voicemail messages.
1. Press **MENU** when the handset is not in use.
 2. Press **∨** or **∧** on the handset, or **CALLER ID / ▼** or **PHONEBOOK / ▲** to scroll to **Phone setup**, and then press **SELECT**.
 3. Press **∨** or **∧** on the handset, or **CALLER ID / ▼** or **PHONEBOOK / ▲** to scroll to **Clear voicemail**, and then press **SELECT**.
 4. Press **YES** to confirm.

Expand your telephone system

You can add new DECT 6.0 cordless handset (**VC7100**) (purchased separately) to your telephone system. This telephone system accommodates up to five DECT cordless handset.

You can also add new ULE Garage Door sensor (**VC7001**), Open/Closed sensor (**VC7002**), or Motion Sensor (**VC7003**) to your telephone system (all purchased separately). You can register up to 400 ULE sensors to the telephone base.

To enter registration mode on the telephone base for handsets

1. Press and hold **Ⓜ/FIND HANDSET** on the telephone base for about 4 seconds when the phone is not in use. The telephone base shows **Registering... Please wait**.
2. Place the new/non-registered handset in the telephone base. The handset and telephone base show **Registering... Please wait**.

To enter the registration mode on the telephone base for sensors:

1. Press **MENU** on the telephone base when idle.
2. Press **∨** or **∧** on the handset, or **CALLER ID /∇** or **PHONEBOOK /▲** to scroll to **Sensor setup**, and then press **SELECT**.
3. Press **∨** or **∧** on the handset, or **CALLER ID /∇** or **PHONEBOOK /▲** to scroll to **Add new sensor**, and then press **SELECT**. The screen displays **For sensor pairing process, see manual**.
4. Press **NEXT** after you initiated the pairing process at your sensor.
5. Press and hold the pair button on the sensor, until the LED light flashes, to enter the registration mode.
 - For motion sensor, use a narrow pointed object such as a pencil to press and hold the **PAIRING** button.

ECO mode

This power conserving technology reduces power consumption for optimal battery performance. The ECO mode activates automatically whenever the handset is synchronized with the telephone base.

General product care

Taking care of your telephone

Your cordless telephone contains sophisticated electronic parts, so it must be treated with care.

Avoid rough treatment

Place the handset down gently. Save the original packing materials to protect your telephone if you ever need to ship it.

Avoid water

Your telephone can be damaged if it gets wet. Do not use the handset outdoors in the rain, or handle it with wet hands. Do not install the telephone base near a sink, bathtub or shower.

Electrical storms

Electrical storms can sometimes cause power surges harmful to electronic equipment. For your own safety, take caution when using electrical appliances during storms.

Cleaning your telephone

Your telephone has a durable plastic casing that should retain its luster for many years. Clean it only with a dry non-abrasive cloth. Do not use dampened cloth or cleaning solvents of any kind.

Storage

When you are not going to use the handset for some time, remove the rechargeable battery from the handset. Store the handset, the charger and the adapter in a cool and dry place.

Frequently asked questions

Below are the questions most frequently asked about the cordless telephone. If you cannot find the answer to your question, visit our website at www.vtechphones.com or call **1 (800) 595-9511** for customer service.

My telephone does not work at all.	Make sure the telephone base is installed properly, and battery is installed and charged correctly. For optimum daily performance, return the handset to the telephone base after use.
	Make sure the handset has registered to the telephone base.
The display shows No line . I cannot get a dial tone.	<p>Disconnect the telephone line cord from your telephone and connect it to another telephone. If there is no dial tone on that other telephone either, then the telephone line cord may be defective. Try installing a new telephone line cord.</p> <p>If changing telephone line cord does not help, the wall jack (or the wiring to this wall jack) may be defective. Contact your telephone service provider.</p> <p>You may be using a new cable or VoIP service, the existing telephone jacks in your home may no longer work. Contact your service provider for solutions.</p>
I get noise, static, or weak signals even when I'm near the telephone base.	<p>Move your phone to a higher location. The phone may have better reception in a high area.</p> <p>If you subscribe to digital subscriber line (DSL) high-speed Internet service through your telephone line, make sure you install a DSL filter (not included) between the telephone line cord and telephone wall jack. Contact your DSL service provider for more information.</p> <p>If other phones in your home are having the same problem, contact your telephone service provider (charges may apply).</p>
The display shows To register HS, see manual to register. The handset does not work at all.	The handset is deregistered from the telephone base. Place the handset in the telephone base to register it back. The handset shows HANDSET X Registered and you hear a beep when the registration process completes. This process takes about 60 seconds to complete.
The display shows Low battery and  flashes.	Place the handset in the telephone base or charger for charging.
The display shows Replace batt in Sensor X .	<p>You need to replace the sensor batteries as follows:</p> <ol style="list-style-type: none"> 1. Press and hold CANCEL on the handset or telephone base to erase the message. 2. Press the pair key on the sensor before replacing batteries. 3. Replace the batteries with new ones.
The battery does not charge in the handset or the handset battery does not accept charge.	Make sure the handset is placed in the telephone base or charger correctly.
	If the battery is completely depleted, charge the battery for at least 30 minutes before use.
	You may need to purchase a new battery.
The telephone does not ring when there is an incoming call.	Make sure the ringer volume is not set to off.
	The handset may be too far from the telephone base. Move it closer to the telephone base.

My handset beeps and is not performing normally.	Move the handset closer to the telephone base. It may be out of range.
I hear other calls when using the telephone.	Disconnect the telephone base from the telephone wall jack. Plug in a different telephone. If you still hear other calls, the problem is probably in the wiring or telephone service. Contact your telephone service provider.
I hear noise on the cordless handset and the keys do not work.	Make sure the telephone line cord is plugged in securely.
There is interference during a telephone conversation. My calls fade out when I am using the cordless handset.	The handset may be out of range. Move it closer to the telephone base.
	If you subscribe to high-speed Internet service (DSL - digital subscriber line) through your telephone line, you must install a DSL filter between the telephone line cord and the telephone wall jack. The filter prevents noise and caller ID problems caused by DSL interference. Contact your DSL service provider for more information about DSL filters.
	Appliances or other cordless telephones plugged into the same circuit as the telephone base can cause interference. Try moving the appliance or telephone base to another outlet.
	The location of your telephone base can impact the performance of your cordless phone. For better reception, install the telephone base in a centralized location within your home or office, away from walls or other obstructions. In many environments, elevating the telephone base improves overall performance.
The telephone does not receive caller ID or the telephone does not show caller ID during call waiting.	Caller ID is a subscription service. You must subscribe to this service from your telephone service provider for this feature to work on your telephone.
	Both you and the caller's telephone service providers must use equipment compatible with the caller ID service.
	The caller may not be calling from an area which supports caller ID.
	The caller ID information displays after the first or second ring.
The display shows Out of range OR no power at base and Put HS on base to power base alternately.	The handset may be out of range. Move it closer to the telephone base.
	Make sure the power cord is securely plugged into the telephone base. Use a working electrical outlet not controlled by a wall switch.
I subscribe to a nontraditional telephone service that uses my computer to establish connections, and my telephone doesn't work.	Make sure your computer is powered on, and your Internet is working properly.
	Make sure to plug your USB telephone adapter into a dedicated USB port on your computer. Do not plug into a multiple port USB hub (USB splitter) that is not powered.
	In a few rare instances, the USB port on your computer may not have enough power. In these instances, try using a USB hub with its own external power supply.
	If you are using a firewall, it may prevent access to your nontraditional telephone service. Contact your service provider for more information.

<p>The sensor does not work at all.</p>	<p>Make sure batteries are installed.</p> <p>Check if the SENSORS softkey is displayed on the idle screen of the telephone base or handset. If yes, press SENSORS and then scroll to check if the desired sensor is on the sensor list. If the desired sensor is not found, then it may be deregistered from the telephone base.</p> <ol style="list-style-type: none"> 1. Press MENU on the telephone base when idle. 2. Scroll to Sensor setup, and then press SELECT. 3. Scroll to Add new sensor, and then press SELECT. The screen displays For sensor pairing process, see manual. 4. Press NEXT after you initiated the pairing process at your sensor. <p>Refer to the online User's manual of VC7151/VC7152, or the User's manual that comes with your new sensor, to register the sensor to the telephone base.</p> <p>The sensor may be out of range. Move the sensor closer to the telephone base.</p>
<p>I cannot receive alerts when the monitored garage door, in-house door, window, or medicine cabinet is opened.</p>	<p>Make sure the sensor alert system is in armed mode and that AL or AR appears on the display.</p> <p>If the icon does not appear on the display, press ARM to turn on the sensor alert system.</p> <p>For various alerts behavior, please check the settings of alert notifications (page 41) and individual sensors' alert schedule (page 37 to 40).</p>
<p>I want to replace an old sensor with a new one.</p>	<p>To replace a sensor, you must deregister the registered sensor first, and then register the new sensor to your ULE compatible product.</p> <ol style="list-style-type: none"> 1. Press MENU when the phone is not in use. 2. Enter the code *33734# to access the DEREGISTER menu. 3. Scroll to Single sensor, and then press SELECT. 4. Scroll to the sensor you want to deregister, and then press SELECT. 5. Press YES to confirm the deregistration. <p>The telephone base shows SENSOR X is deregistered and you hear a beep when the deregistration process completes.</p>
<p>The answering system does not announce the correct day of the week for recorded messages time stamp.</p>	<p>Make sure you have set the date and time. See Configure your telephone section.</p>
<p>The answering system does not answer after correct number of rings or does not record messages.</p>	<p>Make sure the answering system is on. When the answering system is on, the telephone base and handset show ANS ON and the U/ANS ON light on the telephone base is on.</p> <p>If toll saver is selected, the number of rings changes to two when there are new messages.</p>
<p>I accidentally set my LCD language to Spanish or French, and I don't know how to change it back to English.</p>	<p>While the handset is not in use, press MENU and then enter *364# to change the handset LCD language back to English.</p>

The RBRC® seal

The RBRC® seal on the nickel-metal hydride battery indicates that VTech Communications, Inc. is voluntarily participating in an industry program to collect and recycle these batteries at the end of their useful lives, when taken out of service within the United States and Canada.

The RBRC® program provides a convenient alternative to placing used nickel-metal hydride batteries into the trash or municipal waste, which may be illegal in your area.

VTech's participation in RBRC® makes it easy for you to drop off the spent battery at local retailers participating in the RBRC® program or at authorized VTech product service centers. Please call

1 (800) 8 BATTERY® for information on Ni-MH battery recycling and disposal bans/restrictions in your area. VTech's involvement in this program is part of its commitment to protecting our environment and conserving natural resources.

RBRC® and 1 (800) 8 BATTERY® are registered trademarks of the Rechargeable Battery Recycling Corporation.



FCC, ACTA and IC regulations

FCC Part 15

This equipment has been tested and found to comply with the requirements for a Class B digital device under Part 15 of the Federal Communications Commission (FCC) rules. These requirements are intended to provide reasonable protection against harmful interference in a residential installation. This equipment generates, uses and can radiate radio frequency energy and, if not installed and used in accordance with the instructions, may cause harmful interference to radio communications. However, there is no guarantee that interference will not occur in a particular installation. If this equipment does cause harmful interference to radio or television reception, which can be determined by turning the equipment off and on, the user is encouraged to try to correct the interference by one or more of the following measures:

- Reorient or relocate the receiving antenna.
- Increase the separation between the equipment and receiver.
- Connect the equipment into an outlet on a circuit different from that to which the receiver is connected.
- Consult the dealer or an experienced radio/TV technician for help.

Changes or modifications to this equipment not expressly approved by the party responsible for compliance could void the user's authority to operate the equipment.

This device complies with Part 15 of the FCC rules. Operation is subject to the following two conditions: (1) this device may not cause harmful interference, and (2) this device must accept any interference received, including interference that may cause undesired operation. Privacy of communications may not be ensured when using this telephone.

To ensure safety of users, the FCC has established criteria for the amount of radio frequency energy that can be safely absorbed by a user or bystander according to the intended usage of the product. This product has been tested and found to comply with the FCC criteria. The handset may be safely held against the ear of the user. The telephone base shall be installed and used such that parts of the user's body other than the hands are maintained at a distance of approximately 20 cm (8 inches) or more.

This Class B digital apparatus complies with Canadian requirement:
CAN ICES-3 (B)/NMB-3(B)

FCC Part 68 and ACTA

This equipment complies with Part 68 of the FCC rules and with technical requirements adopted by the Administrative Council for Terminal Attachments (ACTA). The label on the back or bottom of this equipment contains, among other things, a product identifier in the format US:AAAEQ##TXXXX. This identifier must be provided to your telephone service provider upon request.

The plug and jack used to connect this equipment to premises wiring and the telephone network must comply with applicable Part 68 rules and technical requirements adopted by ACTA. A compliant telephone cord and modular plug is provided with this product. It is designed to be connected to a compatible modular jack that is also compliant. An RJ11 jack should normally be used for connecting to a single line and an RJ14 jack for two lines. See the installation instructions in the user's manual.

The Ringer Equivalence Number (REN) is used to determine how many devices you may connect to your telephone line and still have them ring when you are called. The REN for this product is encoded as the 6th and 7th characters following the US: in the product identifier (e.g., if ## is 03, the REN is 0.3). In most, but not all areas, the sum of all RENs should be five (5.0) or less. For more information, contact your telephone service provider.

This equipment may not be used with Party Lines. If you have specially wired alarm dialing equipment connected to your telephone line, ensure the connection of this equipment does not disable your alarm equipment. If you have questions about what will disable alarm equipment, consult your telephone service provider or a qualified installer.

If this equipment is malfunctioning, it must be unplugged from the modular jack until the problem has been corrected. Repairs to this telephone equipment can only be made by the manufacturer or its authorized agents. For repair procedures, follow the instructions outlined under the Limited warranty.

If this equipment is causing harm to the telephone network, the telephone service provider may temporarily discontinue your telephone service. The telephone service provider is required to notify you before interrupting service. If advance notice is not practical, you will be notified as soon as possible. You will be given the opportunity to correct the problem and the telephone service provider is required to inform you of your right to file a complaint with the FCC. Your telephone service provider may make changes in its facilities, equipment, operation, or procedures that could affect the proper functioning of this product. The telephone service provider is required to notify you if such changes are planned.

If this product is equipped with a corded or cordless handset, it is hearing aid compatible.

If this product has memory dialing locations, you may choose to store emergency telephone numbers (e.g., police, fire, medical) in these locations. If you do store or test emergency numbers, please:

Remain on the line and briefly explain the reason for the call before hanging up.

Perform such activities in off-peak hours, such as early morning or late evening.

Industry Canada

Operation is subject to the following two conditions: (1) this device may not cause harmful interference, and (2) this device must accept any interference received, including interference that may cause undesired operation.

Privacy of communications may not be ensured when using this phone.

The term "IC:" before the certification/registration number only signifies that the Industry Canada technical specifications were met.

The Ringer Equivalence Number (REN) for this terminal equipment is 0.1. The REN is an indication of the maximum number of devices allowed to be connected to a telephone interface. The termination on an interface may consist of any combination of devices subject only to the requirement that the sum of the RENs of all the devices does not exceed five.

This product meets the applicable Industry Canada technical specifications.

California Energy Commission battery charging testing instructions

This telephone is set up to comply with the energy-conserving standards right out of the box. These instructions are intended for California Energy Commission (CEC) compliance testing only.

When the CEC battery charging testing mode is activated, all telephone functions, except battery charging, will be disabled.

To activate the CEC battery charging testing mode:

1. Unplug the telephone base power adapter from the power outlet. Make sure all handsets are plugged with charged batteries before proceeding.
2. While you press and hold **⏏/FIND HANDSET**, plug the telephone base power adapter back to the power outlet.
3. After about 20 seconds, when the **IN USE** light starts flashing, release **⏏/FIND HANDSET** and then press it again within 2 seconds.

The process takes up to one minute to complete. When the phone successfully enters the CEC battery charging testing mode, the **IN USE** light turns off and all handsets display **To register HS, see manual**.

When the phone fails to enter this mode, repeat Step 1 through Step 3 above. The telephone base will be powered up as normal if you fail to press **⏏/FIND HANDSET** within 2 seconds in Step 3.

To deactivate the CEC battery charging testing mode:

1. Unplug the telephone base power adapter from the power outlet, and then plug it back in. Then the telephone base is powered up as normal.
2. Place the handset in the telephone base to register it back. The handset displays **Registering... Please wait**.

NOTE

The handset and telephone base show **HANDSET X Registered** and you hear a beep when the registration process completes. This process takes about 90 seconds to complete.

For C-UL and cETL compliance only

Mesures de sécurité importantes

Afin de réduire les risques d'incendie, de blessures corporelles ou d'électrocution, suivez toujours ces mesures préventives de base lorsque vous utilisez votre téléphone :

1. Lisez et comprenez bien toutes les instructions.
2. Observez toutes les instructions et mises en garde inscrites sur l'appareil.
3. Débranchez ce téléphone de la prise murale avant de le nettoyer. N'utilisez pas de nettoyeurs liquides ni en aérosol. N'utilisez qu'un chiffon doux et légèrement humecté.
4. N'utilisez pas ce produit près de l'eau, tel que près d'un bain, d'un lavabo, d'un évier de cuisine, d'un bac de lavage ou d'une piscine, ou dans un sous-sol humide ou sous la douche.
5. Ne déposez pas ce téléphone sur un chariot, support ou table chancelants. L'appareil pourrait tomber et être sérieusement endommagé.
6. Le boîtier de l'appareil est doté de fentes et d'ouvertures d'aération situées à l'arrière ou en dessous. Afin d'empêcher la surchauffe, ces ouvertures ne doivent pas être obstruées en plaçant l'appareil sur un lit, divan, tapis ou autre surface similaires. Ne placez pas cet appareil à proximité d'un élément de chauffage ni d'une plinthe électrique. De plus, ne l'installez pas dans une unité murale ou un cabinet fermé qui ne possède pas d'aération adéquate.
7. Ne faites fonctionner cet appareil qu'avec le type d'alimentation indiqué sur les étiquettes de l'appareil. Si vous ne connaissez pas le voltage de votre maison, consultez votre marchand ou votre fournisseur d'électricité.
8. Ne déposez rien sur le cordon d'alimentation. Installez cet appareil dans un endroit sécuritaire, là où personne ne pourra trébucher sur la ligne d'alimentation ni le cordon téléphonique modulaire.
9. N'insérez jamais d'objets à travers les fentes et ouvertures de cet appareil, car ils pourraient toucher à des points de tension dangereux ou court-circuiter des pièces, ce qui constituerait un risque d'incendie ou d'électrocution. N'échappez pas de liquides dans l'appareil.
10. Afin de réduire les risques d'électrocution, ne démontez pas l'appareil, mais apportez-le plutôt à un centre de service qualifié s'il doit être réparé. En enlevant le couvercle, vous vous exposez à des tensions dangereuses ou autres dangers similaires. Un remontage inadéquat peut être à l'origine d'une électrocution lors d'une utilisation ultérieure de l'appareil. Débranchez l'appareil avant de procéder au nettoyage. Utilisez un chiffon humide et doux.
11. Ne surchargez pas les prises de courant et les rallonges.
12. Débranchez cet appareil de la prise de courant et communiquez avec le département de service à la clientèle de VTech dans les cas suivants:
 - Lorsque le cordon d'alimentation est endommagé ou écorché.
 - Si du liquide a été échappé dans l'appareil.

- Si l'appareil a été exposé à une source d'humidité telle que la pluie ou l'eau.
 - Si le produit ne fonctionne pas
 - normalement en respectant les instructions de fonctionnement. Réglez uniquement les commandes indiquées dans les instructions de fonctionnement. Les réglages incorrects des autres commandes pourraient provoquer un dommage qui pourrait exiger un travail exhaustif de la part d'un technicien autorisé afin de rétablir le fonctionnement normal de l'appareil.
 - Si le produit a été échappé et que le socle et/ou le combiné a été endommagé.
 - Si le produit affiche une nette diminution de sa performance.
13. Évitez d'utiliser un téléphone (autre qu'un sans fil) pendant un orage. Les éclairs peuvent être à l'origine d'une électrocution.
 14. N'utilisez pas le téléphone pour rapporter une fuite de gaz à proximité de la fuite. En certaines circonstances, une flammèche pourrait être provoquée lorsque l'adaptateur est branché à une prise de courant, ou lorsque le combiné est déposé sur le socle. Ceci est un événement commun associé à la fermeture d'un circuit électrique. L'utilisateur ne devrait pas brancher le téléphone à une prise de courant, et ne devrait pas déposer le combiné chargé sur le socle, si le téléphone se trouve à proximité d'un endroit comportant des concentrations de gaz inflammables, à moins que la ventilation soit adéquate. Une flammèche dans un tel endroit pourrait provoquer un incendie ou une explosion. De tels environnements peuvent comprendre: des endroits où l'on utilise de l'oxygène médical sans ventilation adéquate; des gaz industriels (dissolvants de nettoyage, des vapeurs d'essence, etc.); une fuite de gaz naturel, etc.
 15. Ne placez que le combiné de votre téléphone près de votre oreille lorsqu'en mode de conversation.
 16. Ces adaptateurs ont été conçus pour être orientés en position verticale ou montés au sol. Les broches ne sont pas conçues pour maintenir l'adaptateur en place si celui-ci est branché dans une prise au plafond ou sous une table/ armoire.

CONSERVEZ CES INSTRUCTIONS

Pile

- **MISE EN GARDE** : Risque d'explosion si la pile est remplacée par une pile de types incorrects. Jetez les piles épuisées en respectant les instructions.
- Ne jetez pas la pile au feu. Vérifiez les instructions spécifiques de mise aux rebus auprès des autorités locales.
- N'ouvrez pas et ne mutilez pas la pile. L'électrolyte qui s'en échapperait est corrosif et pourrait causer des brûlures ou des blessures aux yeux ou à la peau. L'électrolyte est toxique si avalé.
- Soyez prudents lorsque vous manipulez les piles afin d'éviter les courts-circuits provoqués par des matériaux conducteurs.
- Rechargez la pile incluse avec cet appareil, selon les instructions et limites spécifiées dans ce guide d'utilisation.

Stimulateurs cardiaques implantés dans l'organisme

Les simulateurs cardiaques (s'applique uniquement aux téléphones numériques sans fil):

L'organisme 'Wireless Technology Research, LLC (WTR)', une firme de recherche indépendante, a mené une évaluation pluridisciplinaire des interférences entre les téléphones sans fil portatifs et les stimulateurs cardiaques implantés dans l'organisme. Appuyée par l'Administration des aliments et drogues (FDA) des États-Unis, la firme WTR recommande aux médecins:

Avis aux détenteurs de stimulateurs cardiaques

- Ils doivent tenir le téléphone sans fil à une distance d'au moins six pouces du stimulateur cardiaque.
- Ils ne doivent PAS placer le téléphone sans fil directement sur le stimulateur cardiaque, tel que dans une poche de chemise, lorsque celui-ci est en marche.
- Ils doivent utiliser le téléphone sans fil en l'appuyant sur l'oreille qui se trouve dans la direction opposée au stimulateur cardiaque.

L'étude effectuée par l'organisme WRS n'a pas identifié de risque pour les détenteurs de simulateurs cardiaques causés par les gens qui utilisent un téléphone sans fil à proximité de ceux-ci.

À propos des téléphones sans fil

- **Confidentialité:** Les mêmes caractéristiques qui constituent des avantages pour les téléphones sans fil affichent également des restrictions. Les appels téléphoniques sont transmis entre le combiné sans fil et le socle par le biais d'ondes radio ; il y a donc la possibilité que vos conversations téléphoniques sans fil soient interceptées par des équipements de réception radio se trouvant dans la portée du combiné sans fil. Pour cette raison, vous ne devez pas percevoir les communications téléphoniques sans fil comme étant aussi confidentielles.
- **Alimentation électrique:** Le socle de ce téléphone sans fil doit être branché à une prise électrique fonctionnelle. La prise électrique ne doit pas être contrôlée par un interrupteur mural. Les appels ne pourront pas être effectués du combiné sans fil si le socle est débranché ou mis hors tension ou si le courant est coupé.
- **Possibilité d'interférences aux téléviseurs:** Certains téléphones sans fil fonctionnent sur des fréquences pouvant causer des interférences aux téléviseurs et aux magnétoscopes. Pour réduire ou prévenir de telles interférences, ne placez pas le socle du téléphone sans fil près ou sur un téléviseur ou magnétoscope. S'il y a présence de parasites, il est conseillé d'éloigner le téléphone sans fil du téléviseur ou du magnétoscope afin de réduire possiblement les interférences.
- **Piles rechargeables:** Manipulez les piles avec soin afin de ne pas les court-circuiter avec des bagues, bracelets ou clés. Les piles ou le conducteur peut surchauffer et causer des blessures. Respectez la polarité adéquate entre la pile et le chargeur.
- **Les bloc-piles rechargeables à l'hydrure métallique de nickel:** Jetez ces blocs-piles de manière écologique et sécuritaire. Ne les incinerez pas et ne les percez pas. Tel que les autres piles de ce type, elles pourraient dégager une matière toxique qui peut causer des blessures corporelles si elles sont brûlées ou percées.

Limited Warranty

What does this limited warranty cover?

The manufacturer of this VTech Product warrants to the holder of a valid proof of purchase (“Consumer” or “you”) that the Product and all accessories provided in the sales package (“Product”) are free from defects in material and workmanship, pursuant to the following terms and conditions, when installed and used normally and in accordance with the Product operating instructions. This limited warranty extends only to the Consumer for Products purchased and used in the United States of America and Canada.

What will VTech do if the Product is not free from defects in materials and workmanship during the limited warranty period (“Materially Defective Product”)?

During the limited warranty period, VTech’s authorized service representative will repair or replace at VTech’s option, without charge, a Materially Defective Product. If we repair the Product, we may use new or refurbished replacement parts. If we choose to replace the Product, we may replace it with a new or refurbished Product of the same or similar design. We will retain defective parts, modules, or equipment. Repair or replacement of the Product, at VTech’s option, is your exclusive remedy. VTech will return the repaired or replacement Products to you in working condition. You should expect the repair or replacement to take approximately 30 days.

How long is the limited warranty period?

The limited warranty period for the Product extends for ONE (1) YEAR from the date of purchase. If VTech repairs or replaces a Materially Defective Product under the terms of this limited warranty, this limited warranty also applies to the repaired or replacement Product for a period of either (a) 90 days from the date the repaired or replacement Product is shipped to you or (b) the time remaining on the original one-year warranty; whichever is longer.

What is not covered by this limited warranty?

This limited warranty does not cover:

1. Product that has been subjected to misuse, accident, shipping or other physical damage, improper installation, abnormal operation or handling, neglect, inundation, fire, water or other liquid intrusion; or
2. Product that has been damaged due to repair, alteration or modification by anyone other than an authorized service representative of VTech; or
3. Product to the extent that the problem experienced is caused by signal conditions, network reliability, or cable or antenna systems; or
4. Product to the extent that the problem is caused by use with non-VTech accessories; or
5. Product whose warranty/quality stickers, product serial number plates or electronic serial numbers have been removed, altered or rendered illegible; or
6. Product purchased, used, serviced, or shipped for repair from outside the United States of America or Canada, or used for commercial or institutional purposes (including but not limited to Products used for rental purposes); or
7. Product returned without a valid proof of purchase (see item 2 on the next page); or

8. Charges for installation or set up, adjustment of customer controls, and installation or repair of systems outside the unit.

How do you get warranty service?

To obtain warranty service in the United States of America, please visit our website at www.vtechphones.com or call **1 (800) 595-9511**. In Canada, go to www.vtechcanada.com or dial **1 (800) 267-7377**.

NOTE: Before calling for service, please review the user's manual - a check of the Product's controls and features may save you a service call.

Except as provided by applicable law, you assume the risk of loss or damage during transit and transportation and are responsible for delivery or handling charges incurred in the transport of the Product(s) to the service location. VTech will return repaired or replaced Product under this limited warranty. Transportation, delivery or handling charges are prepaid. VTech assumes no risk for damage or loss of the Product in transit. If the Product failure is not covered by this limited warranty, or proof of purchase does not meet the terms of this limited warranty, VTech will notify you and will request that you authorize the cost of repair prior to any further repair activity. You must pay for the cost of repair and return shipping costs for the repair of Products that are not covered by this limited warranty.

What must you return with the Product to get warranty service?

1. Return the entire original package and contents including the Product to the VTech service location along with a description of the malfunction or difficulty; and
2. Include a "valid proof of purchase" (sales receipt) identifying the Product purchased (Product model) and the date of purchase or receipt; and
3. Provide your name, complete and correct mailing address, and telephone number.

Other limitations

This warranty is the complete and exclusive agreement between you and VTech. It supersedes all other written or oral communications related to this Product. VTech provides no other warranties for this Product. The warranty exclusively describes all of VTech's responsibilities regarding the Product. There are no other express warranties. No one is authorized to make modifications to this limited warranty and you should not rely on any such modification.

State/Provincial Law Rights: This warranty gives you specific legal rights, and you may also have other rights, which vary from state to state or province to province.

Limitations: Implied warranties, including those of fitness for a particular purpose and merchantability (an unwritten warranty that the Product is fit for ordinary use) are limited to one year from the date of purchase. Some states/provinces do not allow limitations on how long an implied warranty lasts, so the above limitation may not apply to you. In no event shall VTech be liable for any indirect, special, incidental, consequential, or similar damages (including, but not limited to lost profits or revenue, inability to use the Product or other associated equipment, the cost of substitute equipment, and claims by third parties) resulting from the use of this Product. Some states/provinces do not allow the exclusion or limitation of incidental or consequential damages, so the above limitation or exclusion may not apply to you.

Please retain your original sales receipt as proof of purchase.

Technical Specifications

Frequency control	Crystal controlled PLL synthesizer
Transmit frequency	1921.536-1928.448 MHz
Channels	5
Sensor operating temperature	0°F (-18°C) to 130°F (55°C)
Nominal effective range	Maximum power allowed by FCC and IC. Actual operating range may vary according to environment conditions at the time of use.
Power requirements	Handset: 2.4V 400mAH 2xAAA Ni-MH battery Telephone base: 6V DC @ 600mA Charger: 6V DC @ 400mA Sensor: 2xAAA batteries
Memory	Phonebook: 50 memory locations, up to 30 digits and 15 characters Caller ID log: 50 memory locations; up to 24 digits and 15 characters

Disclaimer

This product is not designed for security purposes. When properly installed and maintained, this product may in some cases reduce the risk of burglary, fire, robbery or other events occurring without providing an alarm. VTech is not responsible for losses, injury, or damage resulting from the use of this product.

This product is covered by U.S. Patent #8,825,043. Other patents may be pending.

 Designed to fit your home.
And your life.

VTech Communications, Inc.

A member of THE VTECH GROUP OF COMPANIES.

VTech is a registered trademark of VTech Holdings Limited.

Specifications are subject to change without notice.

Copyright © 2015 for VTech Communications, Inc.

All rights reserved. 10/15. VC715X_WEB CIB_V1.0

Document order number: 91-008854-010-100

