

vtech®

Complete user's manual

www.vtechphones.com



Models: LS6195/
LS6195-13/LS6195-15/
LS6195-16/LS6195-17

DECT 6.0

Congratulations

on purchasing your new VTech product. Before using this telephone, please read **Important safety instructions** on page 68 of this manual.

This manual has all the feature operations and troubleshooting necessary to install and operate your new VTech telephone. Please review this manual thoroughly to ensure proper installation and operation of this innovative and feature rich VTech product. For support, shopping, and everything new at VTech, visit our website at www.vtechphones.com. In Canada, please visit www.vtechcanada.com.



The ENERGY STAR® program (www.energystar.gov) recognizes and encourages the use of products that save energy and help protect our environment. We are proud to mark this product with the ENERGY STAR® label indicating it meets the latest energy efficiency guidelines.



Telephones identified with this logo have reduced noise and interference when used with most T-coil equipped hearing aids and cochlear implants. The TIA-1083 Compliant Logo is a trademark of the Telecommunications Industry Association. Used under license.

Register online to get an additional 3-month warranty!
Visit www.vtechphones.com.



Registration

Register your product online for enhanced warranty support.



Product news

Learn about the latest VTech products.

Table of contents

Getting started	1
Parts checklist	1
Telephone base installation	2
Handset battery installation	3
Handset battery charging	4
Telephone base layout	5
Handset layout.....	8
Using the menu	10
Telephone base settings	11
Handset ringer volume	11
Telephone base ringer volume	11
Ringer tone	11
Quiet mode	12
Set date and time	13
LCD language.....	14
Base LCD language	14
Voicemail number.....	15
Clear voicemail indicators.....	16
Key tone	16
Home area code	17
Dial mode	17
Auto answer.....	18
Telephone operation	19
Make a call	19
Predial a call.....	19
Answer a call	20
End a call.....	20
Handset speakerphone	20
Volume control.....	20
Mute.....	21
Call waiting	21
Temporary ringer silencing.....	21
Temporary tone dialing.....	22
Chain dialing.....	22
Check voicemail	23
Find handset.....	23
Website.....	23
Redial	24
Transfer a call.....	25
Multiple handset use	26
Join a call in progress.....	26

Intercom.....	27
Answer an incoming call during an intercom call.....	27
Call transfer using intercom.....	28

Directory	29
About the directory	29
Add a directory entry	30
Review directory entries	32
Alphabetical search	32
Dial a directory entry.....	33
Edit a directory entry.....	33
Delete a directory entry	34
Speed Dial	35
Assign a speed dial slot.....	35
Reassign a speed dial slot.....	35
Dial a speed dial number.....	36
Delete a speed dial entry.....	36

Caller ID	37
About caller ID	37
Information about caller ID with call waiting.....	37
Caller ID log.....	38
Memory match.....	38
Missed call indicator	39
Review the caller ID log.....	39
View dialing options.....	40
Dial a caller ID log entry	41
Save a caller ID log entry to the directory	41
Delete caller ID log entries	42
Caller ID log screen messages.....	42

Answering system settings	43
Answering system	43
Announcement	43
Record your own announcement.....	43
Play your announcement.....	43
Delete your announcement	44
Answer on/off.....	44
Call screening.....	45
Number of rings	45
Remote access code	46

Table of contents

Message alert tone	46
Recording time	47

Answering system operation...48

Answering system and voicemail	48
Using the answering system and voicemail together	48
Message capacity	49
New message indication	49
Call screening	49
Call intercept	50
Temporarily turn off the message alert tone	50
Message playback	51
Delete all old messages	52
Record, play and delete memos	52
Remote access	53

Appendix54

Expand your telephone system	54
Add and register a handset	54
Deregister handsets	55
Screen messages	56
Handset and telephone base indicators	58
Battery	59
Troubleshooting	60
Important safety instructions	68
Precautions for users of implanted cardiac pacemakers	69
Operating range	69
ECO mode	69
Maintenance	70
About cordless telephones	70
The RBRC [®] seal	71
FCC, ACTA and IC regulations	72
Limited warranty	74
Technical specifications	76

Index77

Getting started

Parts checklist

Your telephone package contains the following items. Save your sales receipt and original packaging in case it is necessary to ship your telephone for warranty service.

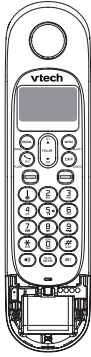

Handset

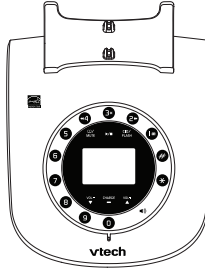

Telephone base

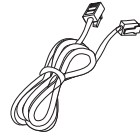

Telephone line cord

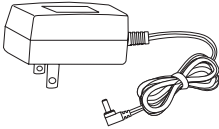

Telephone base power adapter



Battery compartment cover



Battery

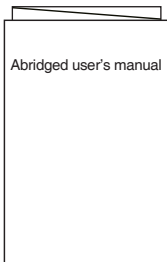

Abridged user's manual

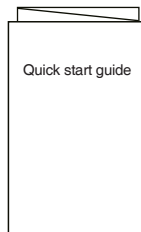

Quick start guide

note

To purchase replacement batteries or power adapters, visit our website at www.vtechphones.com or call 1 (800) 595-9511. In Canada, go to www.vtechcanada.com or dial 1 (800) 267-7377.

Getting started

Telephone base installation

Install the telephone base as shown below.

Make sure that the electrical outlet is not controlled by a wall switch.

If you subscribe to digital subscriber line (DSL) high-speed Internet service through your telephone line, you must install a DSL filter between the telephone line cord and the telephone wall jack. The filter prevents noise and caller ID problems caused by DSL interference. Contact your DSL service provider for more information about DSL filters.

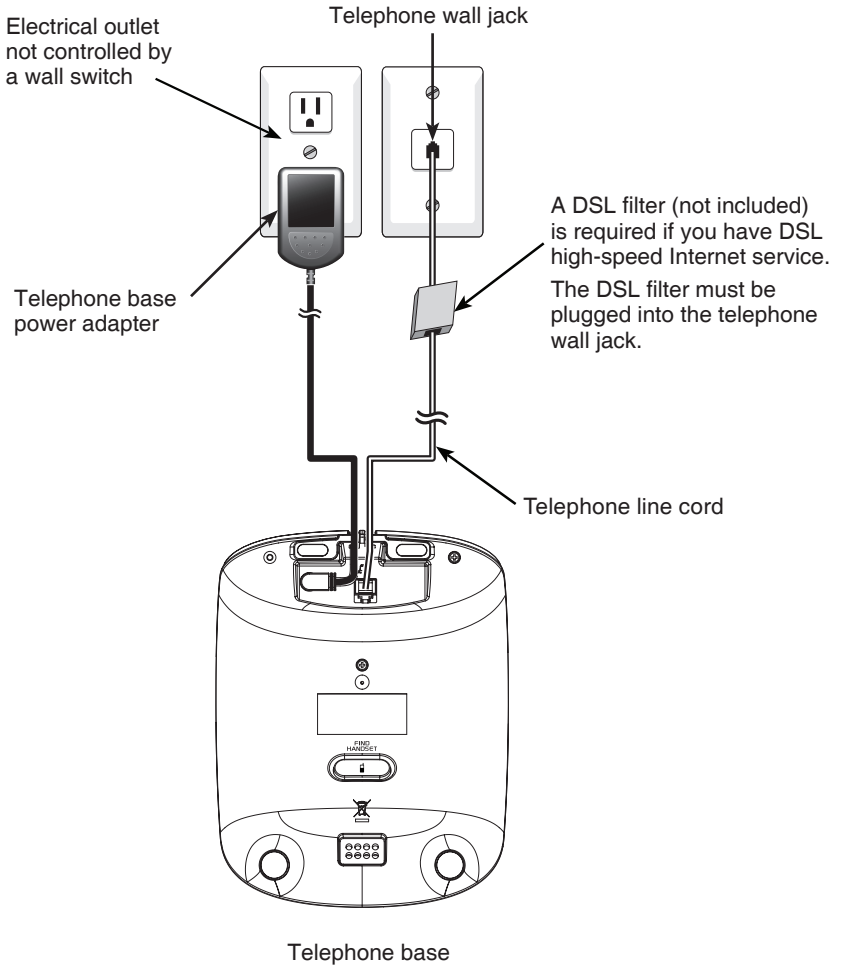

Getting started

Handset battery installation

Install the battery as shown below.

1. Insert the battery connector securely into the socket, matching the color-coded label.
2. Place the battery with the label **THIS SIDE UP** facing up and the wires inside the battery compartment.

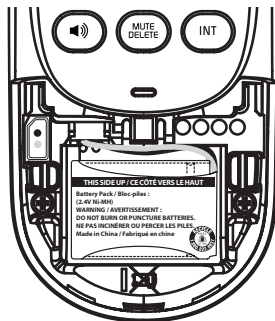
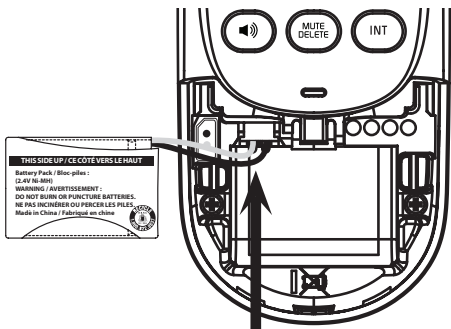

3. Align the cover flat against the battery compartment, then slide it towards the center of the handset until it clicks into place.
4. Charge the handset by placing it in the telephone base. The **CHARGE** light is on when the handset is charging.

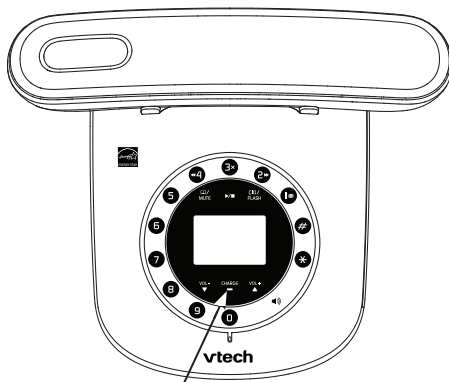
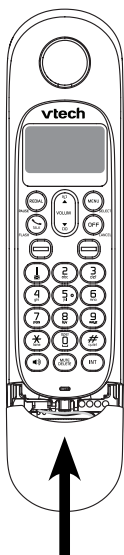

- note** • If the handset will not be used for a long time, disconnect and remove the battery to prevent possible leakage.
- To purchase replacement batteries, visit our website at www.vtechphones.com or call 1 (800) 595-9511. In Canada, go to www.vtechcanada.com or dial 1 (800) 267-7377.



Getting started

Handset battery charging

Once you have installed the battery, the screen indicates the battery status (see the table below). If necessary, place the handset in the telephone base to charge the battery. For best performance, keep the handset in the telephone base when not in use. The battery is fully charged after 11 hours of continuous charging. See the table on page 59 for battery operating times.

If the screen is blank or displays **Put in charger**, you need to charge the handset without interruption for at least 30 minutes to give the handset enough charge to use the telephone for a short time. When the battery is low, the handset displays **Low battery** along with a flashing  icon. If you are on a call in low battery mode, the handset plays short beeps to alert you.

The following table summarizes the battery charge indicators and actions to take.

Battery indicators	Battery status	Action
The screen is blank, or displays Put in charger and  flashes.	The battery has no or very little charge. The handset cannot be used.	Charge without interruption (about 30 minutes).
The screen displays Low battery and  flashes.	The battery has enough charge to be used for a short time.	Charge without interruption (about 30 minutes).
The screen displays HANDSET X.	The battery is charged.	To keep the battery charged, place it in the telephone base when not in use.

note

If you place the handset in the telephone base without installing a battery, the screen displays **No battery**.

After you install your telephone or power returns following a power outage, the handset will prompt you to set the date and time. For instructions, see **Set date and time** on page 13. To skip setting the date and time, press **OFF/CANCEL**.

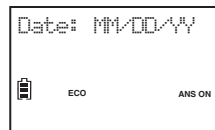

Getting started

Telephone base layout

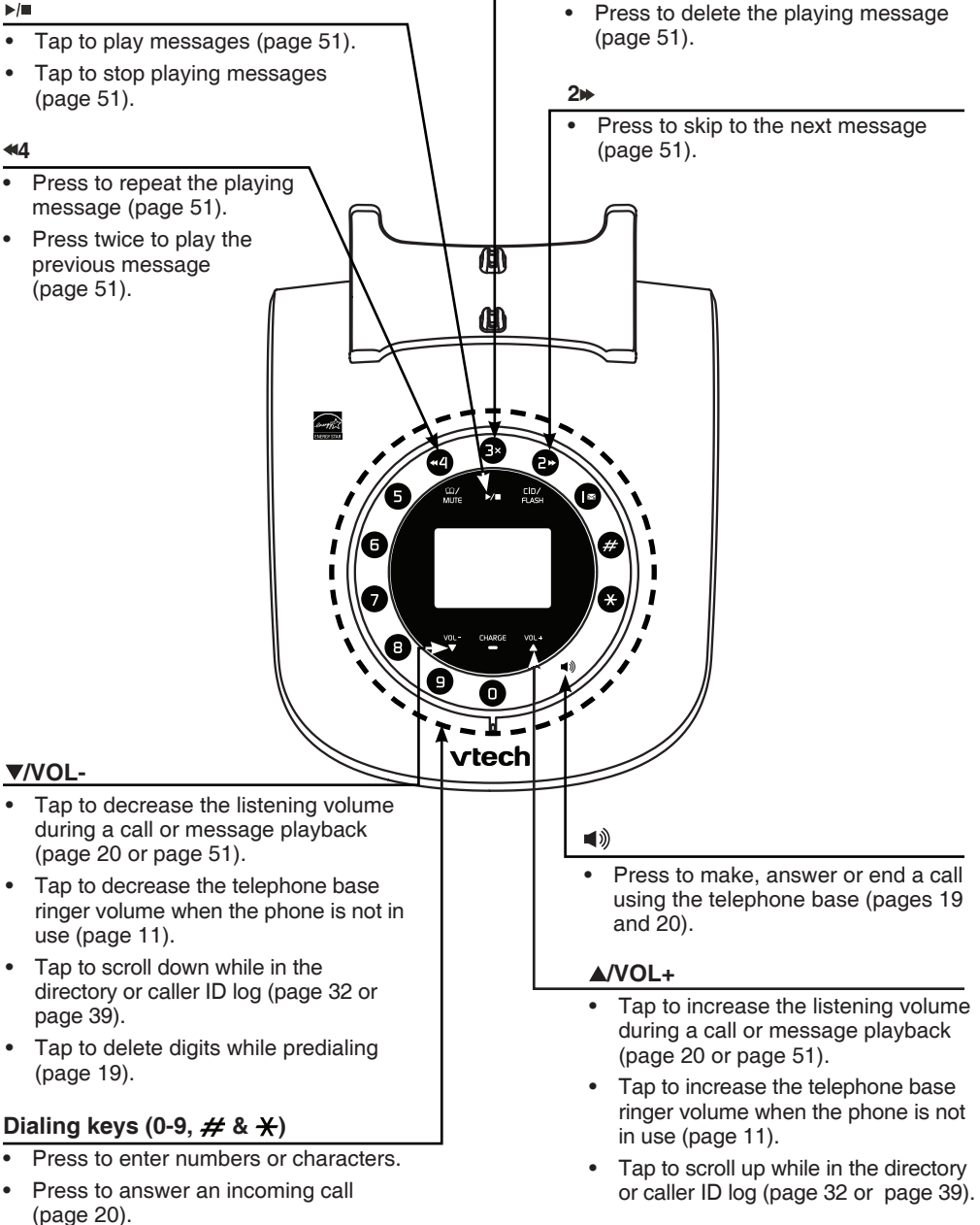

Getting started

Telephone base layout

/MUTE

- Tap to review the directory when the phone is not in use (page 32).
- When the telephone base is in the directory, tap to return to idle mode.
- During a call, tap to mute the microphone (page 21).
- While the phone is ringing, tap to silence the ringer temporarily (page 21).

- While reviewing a caller ID log entry, press repeatedly to add or remove 1 in front of the telephone number before dialing or saving it in the directory (page 40).
- **Press and hold** to set or dial your voicemail number (pages 15 and 23).

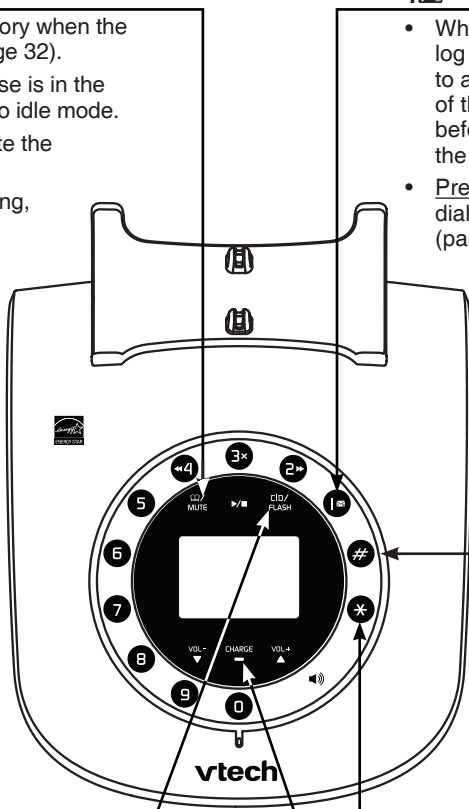

#

- Press repeatedly to show other dialing options when reviewing a caller ID log entry (page 40).

CID/FLASH

- Tap to review the caller ID log when the phone is not in use (page 39).
- When the telephone base is in the caller ID log, tap to return to idle mode.
- Tap to answer another incoming call during a call (page 21).

*

- Press to switch to tone dialing during a call if you have pulse service (page 22).

CHARGE light

- On when the handset is charging in the telephone base (page 3).

Getting started

Telephone base layout

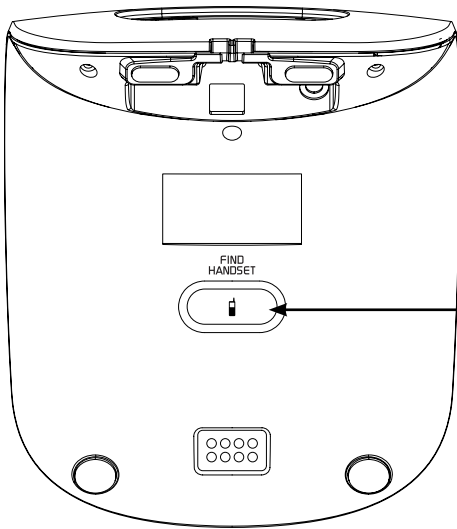

/FIND HANDSET

- Press to page the system handset (page 23).

Bottom of the telephone base

Getting started

Handset layout

/▲/VOLUME

- Press to review the directory when the phone is not in use (page 32).
- Press to scroll up while in a menu, or in the directory, caller ID log or redial list.
- While entering names or numbers, press to move the cursor to the right.
- During a call or message playback, press to increase the listening volume (page 20 or page 51).

REDIAL/PAUSE

- Press repeatedly to view the last 10 numbers dialed (page 24).
- While entering numbers, press and hold to insert a dialing pause (pages 19, 30 and 33).

/FLASH

- Press to make or answer a call (page 19 or page 20).
- During a call, press to answer an incoming call when you receive a call waiting alert (page 21).

1/

- While reviewing a caller ID log entry, press repeatedly to add or remove 1 in front of the telephone number before dialing or saving it in the directory (page 40).
- Press and hold to set or dial your voicemail number (pages 15 and 23).

Dialing keys (0-9, &)

- Press to enter numbers or characters.
- Press to answer an incoming call (page 20).

tone

- Press to switch to tone dialing during a call if you have pulse service (page 22).

- Press to make or answer a call using the handset speakerphone (pages 19 and 20).
- During a call, press to switch between the handset speakerphone and the handset earpiece (page 20).

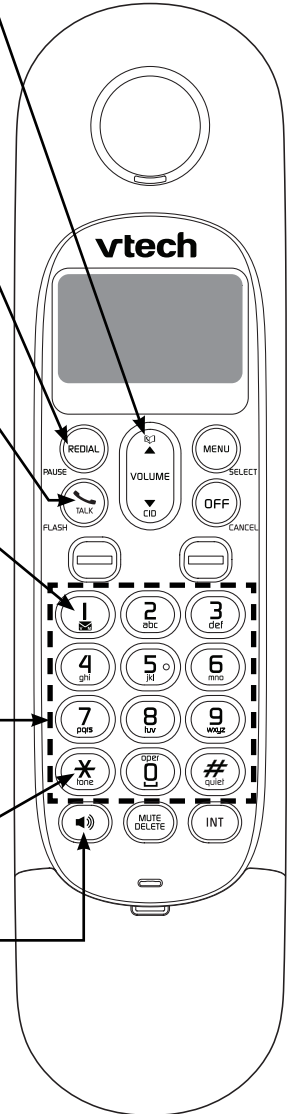

Getting started

Handset layout

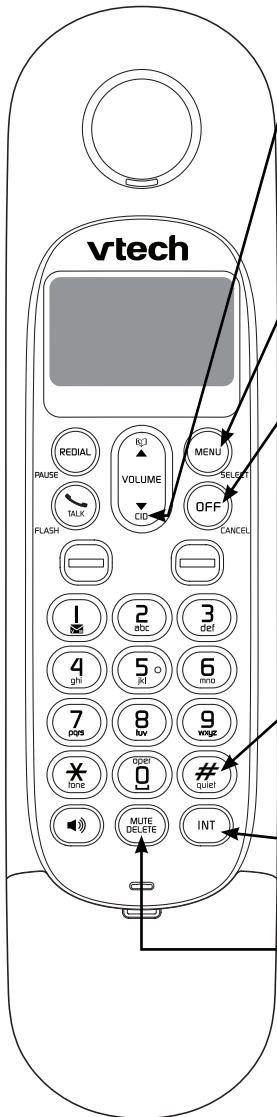

CID/VOLUME

- Press to review the caller ID log when the phone is not in use (page 39).
- Press to scroll down while in a menu, or in the directory, caller ID log or redial list.
- While entering names or numbers, press to move the cursor to the left.
- During a call or message playback, press to decrease the listening volume (page 20 or page 51).

MENU/SELECT

- Press to show the menu (page 10).
- While in the menu, press to select an item or save an entry or setting.

OFF/CANCEL

- During a call, press to hang up (page 20).
- While in a menu, press to return to the previous menu, or press and hold to return to idle mode, without making changes.
- Press to delete digits while predialing (page 19).
- While the phone is ringing, press to silence the ringer temporarily (page 21).
- Press and hold to erase the missed call indicator when the phone is not in use (page 39).

quiet

- Press repeatedly to display other dialing options when reviewing a caller ID log entry (page 40).
- Press and hold to set and turn on the quiet mode, or turn it off (page 12).

INT

- Press to start an intercom conversation or transfer a call (page 27 or page 28).

MUTE/DELETE

- During a call, press to mute the microphone (page 21).
- While the phone is ringing, press to silence the ringer temporarily (page 21).
- While reviewing the redial list, directory or caller ID log, press to delete an individual entry (page 24, page 34 and page 42 respectively).
- While entering names or numbers, press to delete digits or characters (page 19).

Getting started

Using the menu

You can use the cordless handset to change your telephone settings.

In the ringers menu, you can select the ringer tones and adjust the ringer volume for incoming calls.

In the settings menu, you can change the settings for LCD language, voicemail number, voicemail indicators, key tone, home area code, dial mode and auto answer.

Go to **Answering system settings** starting on page 43 for instructions on how to modify the answering system settings.

To enter the handset menu:

1. Press **MENU** when the phone is not in use.
 2. Press ▼ or ▲ until the screen displays the desired feature menu.
 3. Press **SELECT** to enter that menu.
- To return to the previous menu, press **CANCEL**.
 - To return to idle mode, press and hold **CANCEL**.

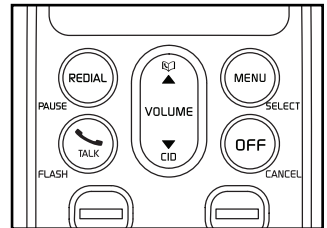

Telephone base settings

Handset ringer volume

You can set the ringer volume or turn the ringer off on each handset. When the ringer is off, the handset displays  and **Ringer off**.

1. Press **MENU** when the handset is not in use.
2. Press **▼** or **▲** to scroll to **◆Ringers**, then press **SELECT**.
3. Press **SELECT** to choose **◆Ringer volume**.
4. Press **▼** or **▲** to sample each volume level.
5. Press **SELECT** to save your selection and return to the previous menu. You hear a confirmation tone.

note

The ringer volume also determines the ringer volume for intercom calls. When the ringer is set to off, that handset is silenced for all incoming calls except paging tone.

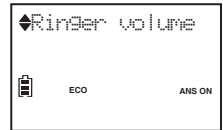
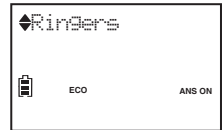

Telephone base ringer volume

Tap **▼/VOL-** or **▲/VOL+** on the telephone base to adjust the ringer volume when the phone is not in use.

When you set the ringer volume to zero, the base ringer is off and the system announces, "Base ringer is off." and the telephone base displays **Ringer off**.

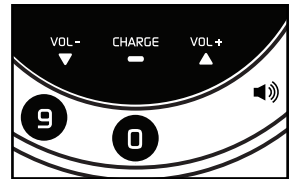

Ringer tone

You can choose from different ringer tones for each handset.

1. Press **MENU** when the handset is not in use.
2. Press **▼** or **▲** to scroll to **◆Ringers**, then press **SELECT**.
3. Press **▼** or **▲** to scroll to **◆Ringer tone**, then press **SELECT**.
4. Press **▼** or **▲** to sample each ringer tone.
5. Press **SELECT** to save your selection and return to the previous menu. You hear a confirmation tone.

note

If you turn off the ringer volume, you will not hear ringer tone samples.

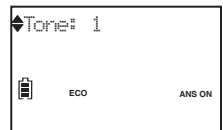
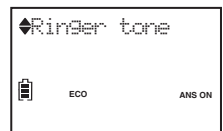
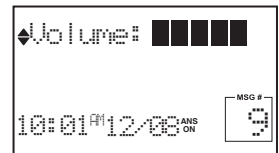

Telephone settings

Quiet mode

You can turn on the quiet mode for a period of time (1-12 hours). During this period, all tones (except paging tone) and call screening are muted.

When you turn on the quiet mode, the answering system turns on automatically.

When the quiet mode duration expires, the answering system remains on.

To set the quiet mode duration:

1. Press and hold **#**_{quiet} when the handset is not in use.
2. The handset displays **Quiet: __ hours**. Use the dialing keys to enter the desired duration (01-12).
3. Press **SELECT** to confirm and return to idle. You hear a confirmation tone. The handset displays **Quiet mode on, ANS ON** and . The telephone base displays **Quiet mode on** and **ANS ON**.

To turn off the quiet mode:

Press and hold **#**_{quiet} when the handset is not in use. The handset displays **Quiet mode off** briefly and then returns to idle.

note

If you change the settings of the ringer tone, handset ringer volume or telephone base ringer volume while the quiet mode is on, you can still hear the samples of them.

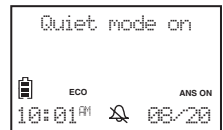
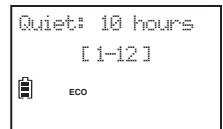
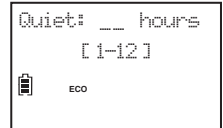

Telephone settings

Set date and time

The answering system announces the date and time of each message prior to playing it. Before using the answering system, set the date and time as follows. If you subscribe to caller ID service, the day, month and time are set automatically with each incoming call. However, the year must be correct so that the day of the week can be calculated from the caller ID information.

1. Press **MENU** when the handset is not in use.
2. Press ▼ or ▲ to scroll to ♦**Set date/time**, then press **SELECT**.
3. Press ▼ or ▲ to select the month then press **SELECT**, or use the dialing keys to enter a two-digit number (01-12).
4. Press ▼ or ▲ to select the date then press **SELECT**, or use the dialing keys to enter a two-digit number (01-31).
5. Press ▼ or ▲ to select the year then press **SELECT**, or use the dialing keys to enter a two-digit number (00-99) then press **SELECT**.
6. Press ▼ or ▲ to select the hour then press **SELECT**, or use the dialing keys to enter a two-digit number (01-12).
7. Press ▼ or ▲ to select the minute then press **SELECT**, or use the dialing keys to enter a two-digit number (00-59).
8. Press ▼ or ▲ to select **AM** or **PM**.
9. Press **SELECT** to save the settings and return to the previous menu. You hear a confirmation tone.

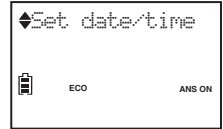

note

- If the date and time are not set when a message is recorded, the system announces, *"Time and date not set,"* before each message plays.
- The telephone plays two beeps if you enter an invalid number.

Telephone settings

LCD language

You can select a language (English, French or Spanish) to be used in all handset screen displays.

1. Press **MENU** when the handset is not in use.
2. Press ▼ or ▲ to scroll to **◆Settings**, then press **SELECT**.
3. Press **SELECT** to select **◆LCD language**.
4. Press ▼ or ▲ to scroll to **◆English**, **◆Français** or **◆Español** then press **SELECT**.

- The handset displays **Set English?** when you select **◆English**.
- The handset displays **Set Francais?** when you select **◆Français**.
- The handset displays **Set Espanol?** when you select **◆Español**.

5. Press **SELECT** to your selection. Then the handset returns to the previous menu. You hear a confirmation tone.

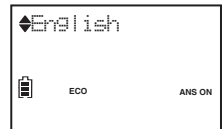
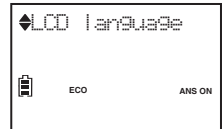
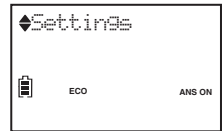

note

- If you accidentally set the LCD language to Spanish or French, press **MENU** and then enter ***364#** on the handset when not in use.
- If you accidentally set the LCD language to Spanish or French while the handset is on a call, press **MENU** and then enter ***364#**. Then press **OFF** to exit the menu.

Base LCD language

You can select a language (English, French or Spanish) to be used in the telephone base screen displays.

1. Press **MENU** when the telephone base is not in use.
2. Press ▼ or ▲ to scroll to **◆Settings**, then press **SELECT**.
3. Press ▼ or ▲ to scroll to **◆Base LCD lang**, then press **SELECT**.
4. Press ▼ or ▲ to scroll to **◆English**, **◆Français** or **◆Español** then press **SELECT**.

- The handset displays **Set English?** when you select **◆English**.
- The handset displays **Set Francais?** when you select **◆Français**.
- The handset displays **Set Espanol?** when you select **◆Español**.

5. Press **SELECT** to your selection. Then the handset returns to the previous menu. You hear a confirmation tone.

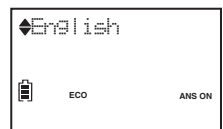
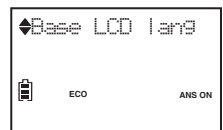
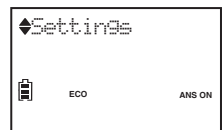

Telephone settings

Voicemail number

If you subscribe to voicemail service offered by your telephone service provider, you can save the voicemail number to **1/✉** for easy access. The voicemail number is shared by the handset and the telephone base. When you want to retrieve voicemail messages, press and hold 1/✉. Contact your telephone service provider for more information and assistance about using your voicemail service.

To set the voicemail number:

1. Press and hold 1/✉ when the phone is not in use.
2. Use the dialing keys to enter the voicemail number (up to 30 digits).
 - Press **DELETE** to erase a digit.
 - Press and hold DELETE to erase all digits.
 - Press **▼** or **▲** to move the cursor to the left or to the right.
 - Press and hold PAUSE to insert a dialing pause (a **P** appears).
3. Press **SELECT** to save. Then the handset dials the saved voicemail number.

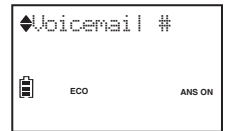
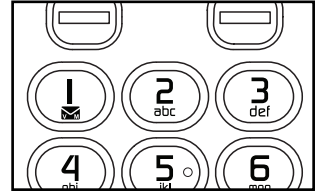

-OR-

1. Press **MENU** when the handset is not in use.
2. Press **▼** or **▲** to scroll to **◆Settings**, then press **SELECT**.
3. Press **▼** or **▲** to scroll to **◆Voicemail #**, then press **SELECT**.
4. Use the dialing keys to enter the voicemail number (up to 30 digits).
 - Press **DELETE** to erase a digit.
 - Press and hold DELETE to erase all digits.
 - Press **▼** or **▲** to move the cursor to the left or to the right.
 - Press and hold PAUSE to insert a dialing pause (a **P** appears).
5. Press **SELECT** to save. The handset displays **VM # saved** and then returns to the previous menu. You hear a confirmation tone.

Telephone settings

Clear voicemail indicators

If you subscribe to voicemail service offered by your telephone service provider, **New voicemail** and  display on the handset and the telephone base when you have new voicemail messages. Contact your telephone service provider for more information and assistance about using your voicemail service.

After you have listened to all new voicemail messages, the indicators on the handset and the telephone base turn off automatically.

Use the clear voicemail feature when the telephone indicates that there is new voicemail but there are none (for example, when you have accessed your voicemail while away from home). Clearing the voicemail waiting indicator only turns off the indicators; it does not delete your voicemail messages. As long as you have new voicemail messages, your telephone service provider continues to send the signal to turn on the indicators.

To manually turn off the new voicemail indicators:

1. Press **MENU** when the handset is not in use.
2. Press ▼ or ▲ to scroll to **◆Settings**, then press **SELECT**.
3. Press ▼ or ▲ to scroll to **◆Clr voicemail**, then press **SELECT**.
The handset displays **Reset VM Icon?**
4. Press **SELECT** to confirm and return to the previous menu.
You hear a confirmation tone.

note

Your telephone service provider may alert you of new messages with a stutter (broken) dial tone. Contact your telephone service provider for details.



Key tone

You can turn the key tone on or off for each handset. If you turn the key tone off, there are no beeps when you press the handset keys.

1. Press **MENU** when the handset is not in use.
2. Press ▼ or ▲ to scroll to **◆Settings**, then press **SELECT**.
3. Press ▼ or ▲ to scroll to **◆Key tone**, then press **SELECT**.
4. Press ▼ or ▲ to choose **◆Key tone:On** or **◆Key tone:Off**.
5. Press **SELECT** to save your selection. Then the handset returns to the previous menu. You hear a confirmation tone.

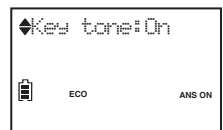
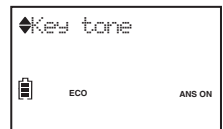

Telephone settings

Home area code

If you dial your local calls using only seven digits (area code not required), you can program your home area code so that when you receive a call within your local area, the telephone number is automatically stored without the area code in the caller ID log.

1. Press **MENU** when the handset is not in use.
2. Press ▼ or ▲ to scroll to **◆Settings**, then press **SELECT**.
3. Press ▼ or ▲ to scroll to **◆Home area code**, then press **SELECT**.
4. Use the dialing keys to enter a three-digit home area code.
 - Press **DELETE** to delete a digit.
 - Press and hold DELETE to delete all digits.
5. Press **SELECT** to save your selection. Then the handset returns to the previous menu. You hear a confirmation tone.

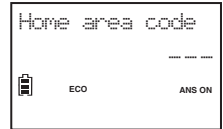
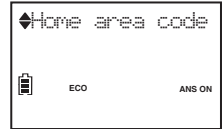

note

If, in the future, your telephone service provider requires you to dial the area code when making a local call, or, if you move to a location that requires it, delete the home area code you have already programmed, following the steps above. After you have deleted the home area code, _ _ _ appears.

Dial mode

The dial mode is preset to touch-tone dialing. If you have pulse (rotary) service, you must change the dial mode to pulse dialing before using the telephone to make a call.

1. Press **MENU** when the handset is not in use.
2. Press ▼ or ▲ to scroll to **◆Settings**, then press **SELECT**.
3. Press ▼ or ▲ to scroll to **◆Dial mode**, then press **SELECT**.
4. Press ▼ or ▲ to choose **◆Touch-tone** or **◆Pulse**.
5. Press **SELECT** to save your selection. Then the handset returns to the previous menu. You hear a confirmation tone.

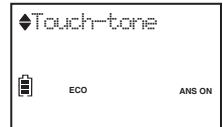
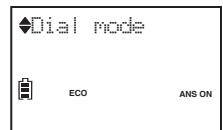

Telephone settings

Auto answer

You can turn on or off the auto answer feature for your handset. If you turn the auto answer feature on, the handset automatically answers an incoming call whenever you pick up the handset from the telephone base.

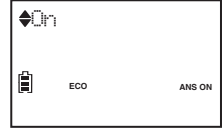

1. Press **MENU** when the handset is not in use.
2. Press ▼ or ▲ to scroll to ♦**Settings**, then press **SELECT**.
3. Press ▼ or ▲ to scroll to ♦**Auto Answer**, then press **SELECT**.
4. Press ▼ or ▲ to choose ♦**On** or ♦**Off**.
5. Press **SELECT** to save your selection. Then the handset returns to the previous menu. You hear a confirmation tone.



Telephone operation

Make a call

Using the handset:

1. Press  or  on the handset.
2. When you hear a dial tone, dial the number.

note

- The handset shows the elapsed time as you talk (in hours, minutes and seconds).
- While entering numbers, press and hold PAUSE to insert a dialing pause (a **P** appears).

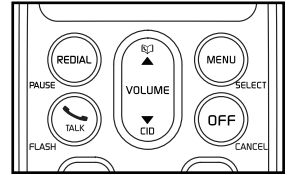

Using the telephone base:

1. Press  on the telephone base.
2. When you hear a dial tone, dial the number.

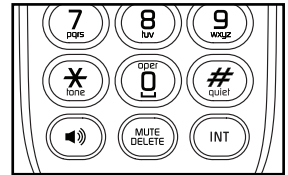

note

The telephone base shows the elapsed time as you talk (in hours, minutes and seconds).



Predial a call

Using the handset:

1. Enter the telephone number.
 - Press **DELETE** or **CANCEL** to make corrections.
2. Press  or  to dial.

note

- The handset shows the elapsed time as you talk (in hours, minutes and seconds).
- While entering numbers, press and hold PAUSE to insert a dialing pause (a **P** appears).
- The handset displays **Unable to call** if you predial a number while your telephone line is in use.

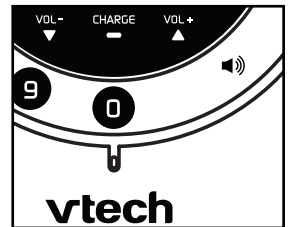

Using the telephone base:

1. Enter the telephone number.
 - Press **▼/VOL-** to make corrections.
2. Press  to dial.

note

- The telephone base shows the elapsed time as you talk (in hours, minutes and seconds).
- The telephone base displays **Unable to call** if you predial a number while your telephone line is in use.

Telephone operation

Answer a call

Using the handset:

- Press  or  or any dialing key (0-9,  or .

-OR-

- Pick up the handset from the telephone base when the auto answer feature is turned on.

Using the telephone base:

- Press  or any dialing key (0-9,  or .

End a call

Using the handset:

- Press **OFF** on the handset or put the handset back in the telephone base.

Using the telephone base:

- Press .

Handset speakerphone

When the handset is on a call, press  to switch between the speakerphone and the handset earpiece.

When the speakerphone is active, the handset displays **Speaker**.



Volume control

Using the handset:

During a call, press **▼/VOLUME** or **▲/VOLUME** to adjust the listening volume.

Using the telephone base:

During a call, tap **▼/VOL-** or **▲/VOL+** to adjust the listening volume.

note

- The handset earpiece and speakerphone volume settings are independent.
- When the volume reaches the minimum or maximum setting, you hear two beeps.

Telephone operation

Mute

The mute function allows you to hear the other party but the other party cannot hear you.

- During a call, press **MUTE** on the handset or tap **MUTE** on the telephone base. The screen displays **Muted** until the mute function is turned off.
- Press **MUTE** on the handset or tap **MUTE** on the telephone base to resume the conversation. The screen briefly displays **Microphone on**.

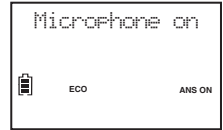

Call waiting

When you subscribe to call waiting service from your telephone service provider, you hear an alert tone if someone calls while you are already on a call.

- Press **FLASH** on the handset or tap **FLASH** on the telephone base to put the current call on hold and take the new call.
- Press **FLASH** on the handset or tap **FLASH** on the telephone base at any time to switch back and forth between calls.

Temporary ringer silencing

When the telephone is ringing, you can temporarily silence the ringer of the handset or the telephone base without disconnecting the call. The next call rings normally at the preset volume.

To silence the handset ringer:

- Press **OFF** or **MUTE** on the handset, then  displays and **Ringer muted** displays briefly.

To silence the telephone base ringer:

- Press **MUTE** or **▼/VOL-** on the telephone base.



note

The handset and the telephone base ring when there is an incoming call unless the ringer volume of that device is turned off.

Telephone operation

Temporary tone dialing

If you have pulse (rotary) service only, you can switch from pulse to touch-tone dialing temporarily during a call. This is useful if you need to send touch-tone signals to access your telephone banking or long distance services.

1. During a call, press ***_{tone}*** on the handset or ***_{tone}*** on the telephone base.
2. Use the dialing keys to enter the number you wish to dial. The telephone sends touch-tone signals. It automatically returns to pulse dialing mode after you end the call.

Chain dialing

Use this feature to initiate a dialing sequence from numbers stored in the directory, caller ID log or redial list while you are on a call using the handset.

Chain dialing can be useful if you wish to access other numbers (such as bank account numbers or access codes) from the directory, caller ID log or redial list.

To access a number from the directory while on a call with the handset:

1. Press **MENU**.
2. Press **SELECT** to select **◆Directory**.
3. Press **▼** or **▲** to scroll to the desired entry.
4. Press **SELECT** to dial the displayed number.

To access a number from the caller ID log while on a call with the handset:

1. Press **MENU**.
2. Press **▼** or **▲** to scroll to **◆Caller ID log**, then press **SELECT**.
3. Press **▼** or **▲** to scroll to the desired entry.
4. Press **SELECT** to dial the displayed number.

To access a number from the redial list while on a call with the handset:

1. Press **REDIAL** to enter the redial list.
2. Press **▼**, **▲** or **REDIAL** repeatedly to browse to the desired entry.
3. Press **SELECT** to dial the displayed number.

note

Press **CANCEL** to exit the directory, caller ID log or redial list when you are on a call.

Telephone operation

Check voicemail

Press and hold **1** on the handset or **1** on the telephone base to dial your stored voicemail number.

note

See **Voicemail number** on page 15 to set your voicemail number.

Find handset

This feature helps you find the misplaced handset.

To start the paging tone:

- Press **FIND HANDSET** at the bottom of the telephone base when not in use. The handset rings and all screens display **** Paging ****.

To stop the paging tone:

- Press **FIND HANDSET** at the bottom of the telephone base.
-OR-
- Press **TALK**, **quiet**, **CANCEL** or any dialing key (**0-9**, ***_{tone}** or **#_{quiet}**) on the handset.
-OR-
- Place the handset in the telephone base.

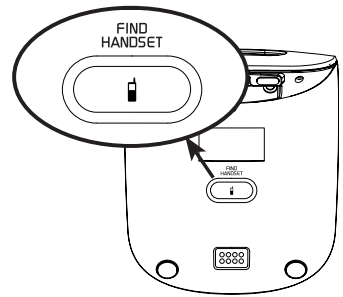

note

Press **MUTE** to turn off the ringer of that handset. Its screen shows **Ringer muted** and .

Website

Use this feature to view the VTech website address.

1. Press **MENU** when the handset is not in use.
2. Press **▼** or **▲** to highlight **◆Web address**, then press **SELECT**.
The screen displays the website address.

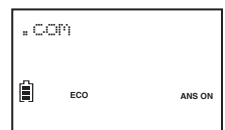
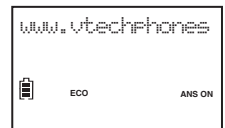
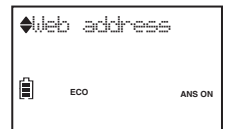

Telephone operation

Redial

Each handset stores the last 10 telephone numbers dialed (up to 30 digits). When there are already 10 entries, the oldest entry is deleted to make room for the new entry.

To review and dial a redial number:

1. Press **REDIAL** when the phone is not in use.
2. Press **▼**, **▲** or **REDIAL** repeatedly to browse until the desired entry displays.
3. Press **TALK** or **▶▶** to dial.



-OR-

1. Press **TALK** OR **▶▶**.
2. Press **REDIAL** when the phone is not in use.
3. Press **▼**, **▲** or **REDIAL** repeatedly to browse until the desired entry displays.
4. Press **SELECT** to dial.

To delete a redial number:

- While the handset displays the desired number, press **DELETE** to delete the number from the redial memory. You hear a confirmation tone.

Telephone operation

Transfer a call

While on an outside call, you can transfer the call from one system device to another.

To transfer a call from the handset:

1. During a call, press **MENU**.
2. Press ▼ or ▲ to scroll to **Transfer**, then press **SELECT**.
 - If you have only one handset, the outside call is put on hold and your handset shows **Calling base** briefly, then displays **Transferred**.
 - If you have more than one handset, use the dialing keys to enter a destination device number (**7** for the telephone base, or **1** to **5** for **HANDSET 1** to **HANDSET 5**). The outside call is put on hold and your handset shows **Calling HS X** or **Calling base** briefly, then displays **Transferred**.
3. The destination device rings and shows **Incoming call**. To answer the call, press **ANS** on the telephone base or press **TALK**, **ANS** or any dialing key (**0-9**, ***** or **#**) on the destination handset.

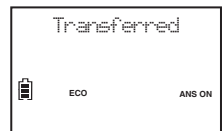
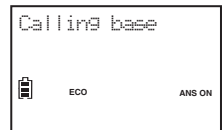

To transfer a call from the telephone base:

- Pick up the handset from the telephone base.

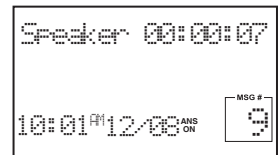

note





- If the destination handset is out of range, your handset shows **Unable to call** and then automatically returns to the external call.
- If the destination device does not answer the transferring call within 30 seconds, the call will be reverted to the originating handset. If you do not press **TALK**, **ANS** or any dialing key (**0-9**, ***** or **#**) on the handset to reconnect the outside call within 30 seconds, the call ends automatically.

Multiple handset use

Join a call in progress

You can use two system devices at a time on an outside call. You can buy additional expansion handsets (**LS6005/LS6005-13/LS6005-15/LS6005-16/LS6005-17**) for this telephone base. You can register up to five handsets to the telephone base.

To join a call:

- When a device is already on a call, press  or  on another handset or  on the telephone base to join the call.
- To exit the call, press **OFF** on the handset or place it back in the telephone base, or press  on the telephone base. The call continues until the other device hangs up.

Multiple handset use

Intercom

Use the intercom feature for conversations between the handset and another system device.

1. Press **INT** on the handset when not in use.

- If you have only one handset, the handset displays **Calling base**. The telephone base displays **HS 1 is calling**.
- If you have more than one handset, use the dialing keys to enter a destination device number (**7** for the telephone base, or **1 to 5** for **HANDSET 1** to **HANDSET 5**). The handset displays **Calling HS X** or **Calling base**. The destination device displays **HS X is calling**.

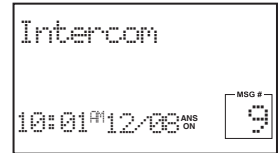

2. To answer the intercom call at the telephone base, press **ANS** or any dialing key (**0-9**, ***** or **#**). Both devices now show **Intercom**.

-OR-

To answer the intercom call with the destination handset, press **TALK**, **ANS** or any dialing key (**0-9**, *****_{tone} or **#**_{quiet}).

3. To end the intercom press **OFF** on the handset or places the handset back in the telephone base, or press **ANS** on the telephone base. Both devices display **Intercom ended**.

note

- You can cancel the intercom call before it is answered by pressing **OFF**.
- If the destination device does not answer the intercom call within 100 seconds, or if it is out of range, on a call, or accessing the answering system, your handset displays **Unable to call** and then returns to idle mode.
- You can press **MUTE** on the telephone base to temporarily silence the intercom ringer.
- Two pairs of intercom calls can be established at a time.

Answer an incoming call during an intercom call

If you receive an outside call during an intercom call, there is an alert tone.

- To answer the call, press **TALK** on the handset, or press **ANS** twice on the telephone base. The intercom call ends automatically.
- To end the intercom call without answering the outside call, press **OFF** on the handset, or press **ANS** on the telephone base. The intercom call ends and the telephone continues to ring.



Multiple handset use



Call transfer using intercom

Use the intercom feature to transfer an outside call on the handset to another system device.

1. During a call, press **INT** on the handset.
 - If you have only one handset, the handset displays **Calling base**. The telephone base displays **HS 1 is calling**.
 - If you have more than one handset, use the dialing keys to enter a destination device number (**7** for the telephone base, or **1** to **5** for **HANDSET 1** to **HANDSET 5**). The handset displays **Calling HS X** or **Calling base**. The destination device displays **HS X is calling**.
2. To answer the intercom call at the telephone base, press  or any dialing key (**0-9**, ***** or **#**).

-OR-

To answer the intercom call with the destination handset, press ,  or any dialing key (**0-9**, *****_{tone} or **#**_{quiet}).

3. The outside call is now on hold and both system devices display **Intercom**. You can have a private conversation with the destination device.
4. From this intercom call, you have the following options:
 - You can let the destination system device join you on the outside call in a three-way conversation. Press and hold INT on the handset.
 - You can transfer the call. Press **OFF**, or place your handset back in the telephone base. Your handset displays **Transferred**. The destination system device then automatically connects to the outside call.
 - You can press **INT** on the handset to switch between the outside call (**Outside call** displays) and the intercom call (**Intercom** displays).
 - To end the intercom call, press **OFF** or  on the handset, or press  on the telephone base. The outside call continues until both devices hang up.

Directory

About the directory

The directory stores up to 50 entries with up to 30 digits for each phone number and 15 characters for each name.

- Directory entries are shared by the handset and the telephone base. Any modifications made on one device apply to all system devices.
- When you access the directory without records, the screen shows **Directory empty**.
- When the directory is full and you try to save an entry, the screen shows **Directory full**.
- When you try to save an entry already stored in the directory, the screen shows **Number repeated**.
- Only one system device can review the directory at a time. When a device tries to enter the directory while another device is already in it, **Not available** displays.

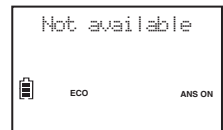
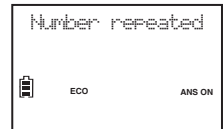

Directory

Add a directory entry

1. Press **MENU** when the phone is not in use.
2. Press ▼ or ▲ to scroll to **Directory**, then press **SELECT**.
3. Press **SELECT** to choose **Add contact**.
4. When **Enter number** displays, use the dialing keys to enter a number (up to 30 digits).
 - Press ▼ or ▲ to move the cursor to the left or right.
 - Press **DELETE** to erase a digit.
 - Press and hold DELETE to erase all digits.
 - Press and hold PAUSE to enter a dialing pause (a **P** appears).

-OR-

Copy a number from the redial list by pressing **REDIAL**. Then press ▼, ▲ or **REDIAL** repeatedly to find the desired number. Press **SELECT** to copy the number.

5. Press **SELECT** to move on to the name.
6. When **Enter name** displays, use the dialing keys to enter a name (up to 15 characters). Each time you press a key, the character on that key appears. Additional key presses produce other characters on that key. Press the key repeatedly until the desired character appears. The first character of every word is capitalized.
 - Press ▼ or ▲ to move the cursor to the left or right.
 - Press **0** to add a space.
 - Press **DELETE** to erase a character.
 - Press and hold DELETE to erase all characters.
7. Press **SELECT** to save. The handset displays **Saved** and then returns to the previous menu. You hear a confirmation tone.

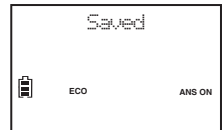
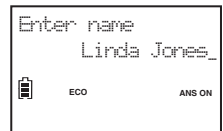
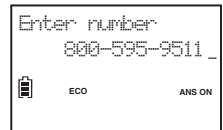

Directory

Add a directory entry

-OR-

1. Use the dialing keys to enter a number (up to 30 digits) when the phone is not in use. Press **SELECT**. The handset displays **Enter number**.

- Press **▼** or **▲** to move the cursor to the left or right.
- Press **DELETE** to erase a digit.
- Press and hold **DELETE** to erase all digits.
- Press and hold **PAUSE** to enter a dialing pause (a **P** appears).

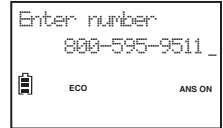
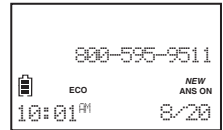

-OR-

Copy a number from the redial list by pressing **REDIAL**. Then **▼**, **▲** or **REDIAL** repeatedly to find the desired number. Press **SELECT** to copy the number.

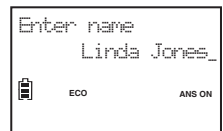

2. Press **SELECT** to move on to the name.

3. When **Enter name** displays, use the dialing keys to enter a name (up to 15 characters). Each time you press a key, the character on that key appears. Additional key presses produce other characters on that key. Press the key repeatedly until the desired character appears. The first character of every word is capitalized.

- Press **▼** or **▲** to move the cursor to the left or right.
- Press **0** to add a space.
- Press **DELETE** to erase a character.
- Press and hold **DELETE** to erase all characters.

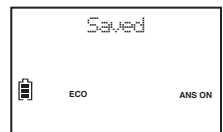







4. Press **SELECT** to save. The handset displays **Saved** and you hear a confirmation tone.









Directory

Review directory entries

Directory entries appear alphabetically.

1. Press  on the handset or tap  on the telephone base when the phone is not in use. The screen displays **Entries in DIR XXX** for a few seconds, then displays the first entry in the directory.
2. Press  or  on the handset or tap  or  on the telephone base to browse through the directory.

-OR-

1. Press **MENU** when the phone is not in use.
2. Press  or  to scroll to **Directory**, then press **SELECT**.
3. Press  or  to scroll to **Review**, then press **SELECT**.
4. The handset displays **Entries in DIR XXX** for a few seconds. Press  or  to browse through the directory.

note

If the telephone number in the directory exceeds 15 digits, - appears after the 14th digit, and then the remaining digits appear beginning with - , alternately.

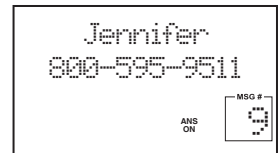
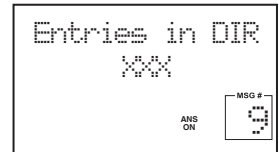









Alphabetical search

You can only perform an alphabetical search on the handset.



1. Press  on the handset when the phone is not in use.

-OR-

- i. Press **MENU** when the phone is not in use.
 - ii. Press  or  to scroll to **Directory**, then press **SELECT**.
 - iii. Press  or  to scroll to **Review**, then press **SELECT**.
2. Use the dialing keys to enter the letter associated with the name. For example, if you have the entries named Jennifer, Jessie, Kevin and Linda in your directory, press **5** (JKL) once to see Jennifer (when **Jennifer** displays, press  to see **Jessie**), twice to see Kevin, or three times to see Linda. If there is no name entry matching your search, the last entry you browsed displays on the screen. If necessary, press  or  to browse.

Directory

Dial a directory entry

1. Search for the desired entry in the directory (see **Review directory entries** or **Alphabetical search** on page 32).
 2. To dial the displayed entry on the cordless handset, press  or .
- OR-**
- To dial the displayed entry on the telephone base, press .

Edit a directory entry

1. Search for the desired entry in the directory (see **Review directory entries** or **Alphabetical search** on page 32).
2. When the desired entry displays, press **SELECT**. The handset displays **Edit number**.
3. Use the dialing keys to edit the name.
 - Press **▼** or **▲** to move the cursor to the left or right.
 - Press **DELETE** to erase a digit.
 - Press and hold **DELETE** to erase all digits.
 - Press and hold **PAUSE** to enter a dialing pause (a **P** appears).
4. Press **SELECT**. The handset displays **Edit name**. Use the dialing keys to edit the number.
 - Press **▼** or **▲** to move the cursor to the left or right.
 - Press **DELETE** to erase a character.
 - Press and hold **DELETE** to erase all characters.
5. Press **SELECT** to save the entry. The handset displays **Saved** and then the revised entry. You hear a confirmation tone.

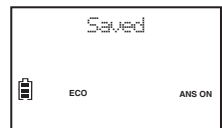
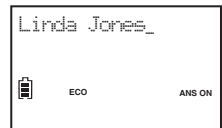
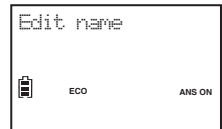
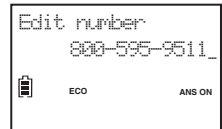

Directory

Delete a directory entry

1. Search for the desired entry in the directory (see **Review directory entries** or **Alphabetical search** on page 32).
2. Press **DELETE** on the handset. The handset displays **Delete contact?**
3. Press **SELECT** to confirm. The handset displays **Deleting...** and then **Contact deleted**. The handset returns to the previous menu and you hear a confirmation tone.



Directory

Speed Dial

You can copy nine of your directory entries to the speed dial locations (**0** and **2-9**) so that you can dial these numbers more quickly. The speed dial entries are shared by all devices. Changes made to the speed dial entries on one handset apply to all devices.

Assign a speed dial slot

1. Press **MENU** when the phone is not in use.
2. Press ▼ or ▲ to scroll to **◆Directory**, then press **SELECT**.
3. Press ▼ or ▲ to scroll to **◆Speed dial**, then press **SELECT**.
4. Press ▼ or ▲, or a dialing key (**0** or **2-9**) to choose the desired speed dial location.
5. Press **SELECT** to show the directory.
6. Press ▼ or ▲ to browse to the desired entry.

-OR-

Use the alphabetical search to find the desired entry (page 32).

7. Press **SELECT** to save. The name (up to 12 characters) appears in the selected speed dial location.

note

If the directory is empty when you press **SELECT** in Step 5, the handset shows **Directory empty**.

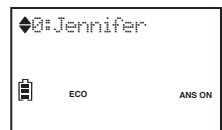
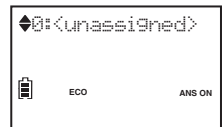
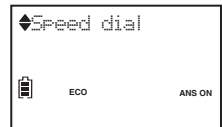
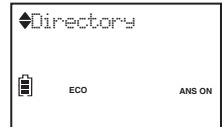

Reassign a speed dial slot

1. Press **MENU** when the phone is not in use.
2. Press ▼ or ▲ to scroll to **◆Directory**, then press **SELECT**.
3. Press ▼ or ▲ to scroll to **◆Speed dial**, then press **SELECT**.
4. Press ▼ or ▲, or a dialing key (**0** or **2-9**) to choose an occupied speed dial location.
5. Press **SELECT** twice to choose **◆Reassign SD**.
6. Press **SELECT** to show the directory.
7. Press ▼ or ▲ to browse to the desired entry.

-OR-

Use the alphabetical search to find the desired entry (see page 32).

8. Press **SELECT** to save. You hear a confirmation tone.

Directory

Dial a speed dial number

Using the handset:

- When the phone is not in use, press and hold a dialing key (**0** or **2-9**) to dial the number stored in the corresponding location.

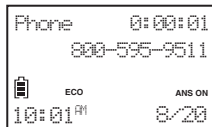

note

When the speed dial location is empty, the handset shows the speed dial list. See **Assign a speed dial slot** on page 35 to add a new entry.

Using the telephone base:

- When the phone is not in use, press and hold a dialing key (**0** or **2-9**) to dial the number stored in the corresponding location.

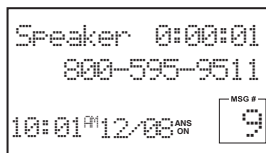

Delete a speed dial entry

- Press **MENU** when the phone is not in use.
- Press **▼** or **▲** to scroll to **◆Directory**, then press **SELECT**.
- Press **▼** or **▲** to scroll to **◆Speed dial**, then press **SELECT**.
- Press **▼** or **▲**, or a dialing key (**0** or **2-9**) to choose the desired speed dial location.
- Press **DELETE**.

-OR-

Press **SELECT** twice. Press **▼** or **▲** to scroll to **◆Clear SD**, then press **SELECT**.

- When the handset displays **Clear SD #X?**, press **SELECT**. You hear a confirmation tone.

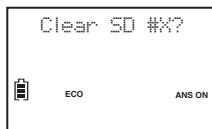
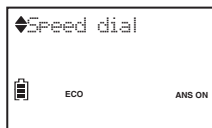
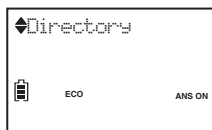

note

Deleting the speed dial entries does not affect the entries in the directory.

Caller ID

About caller ID

This product supports caller ID services offered by most telephone service providers. Depending on your service subscription, you may see the caller's number, or the caller's name and number that are sent by your telephone service provider after the first or second ring. Caller ID allows you to see the name, number, date and time of calls.

Information about caller ID with call waiting

Caller ID with call waiting lets you see the name and telephone number of the caller before answering the call, even while on another call.

It may be necessary to change your telephone service to use this feature. Contact your telephone service provider if:

- You have both caller ID and call waiting, but as separate services (you may need to combine these services).
- You have only caller ID service, or only call waiting service.
- You do not subscribe to caller ID or call waiting services.

There are fees for caller ID services. In addition, services may not be available in all areas.

This product can provide information only if both you and the caller are in areas offering caller ID service and if both telephone service providers use compatible equipment. The time and date, along with the call information, are from the telephone service provider.

Caller ID information may not be available for every incoming call. Callers may intentionally block their names and/or telephone numbers. To view caller ID log entries with numbers between 16 and 24 digits, you must save the entry to the directory (see page 41).

You can use this product with regular caller ID service, or you can use this product's other features without subscribing to caller ID or combined caller ID with call waiting service.

Caller ID

Caller ID log

If you subscribe to caller ID service, information about each caller will appear after the first or second ring. If you answer a call before the caller's information appears, it will not be saved in the caller ID log.

- The caller ID log stores up to 50 entries. Each entry has up to 24 digits for the phone number and 15 characters for the name. If the phone number has more than 15 digits, only the last 15 digits appear. If the name has more than 15 characters, only the first 15 characters are shown and saved in the caller ID log.
- Caller ID log entries are shared by all system devices. Any modifications made on one handset apply to all.
- You can review, redial, and copy an entry into the directory.
- Entries appear in reverse chronological order.
- When the caller ID log is full, the oldest entry is deleted to make room for new incoming call information.
- **XX missed calls** shows when there are new caller ID log entries that have not been reviewed.
- **Call log empty** shows when you access the caller ID log without records.
- Only one system device can review the caller ID log at a time. If a system device tries to enter the caller ID log while another system device is already in it, its screen displays **Not available**.

Memory match

If the incoming telephone number matches the last seven digits of a telephone number in your directory, the name that appears on the screen matches the corresponding name in your directory.

For example, if Mike Smith calls, his name appears as **Mike** if this is how you entered it into your directory.

note

The number shown in the caller ID log will be in the format sent by the telephone service provider. The telephone service provider usually delivers 10-digit phone numbers (area code plus telephone number). If the phone number of the caller does not match a number in your directory, the name will appear as it is delivered by the telephone service provider.

Caller ID

Missed call indicator

When there are calls that have not been reviewed in the caller ID log, the screens display **XX missed calls**. When you have reviewed all the missed calls, the missed call indicator goes away.

Each time you review a caller ID log entry marked **NEW** on the handset or **NEW** on the telephone base, the number of missed calls decreases by one.

If you do not want to review the missed calls one by one, press and hold **CANCEL** on the handset when not in use to clear the missed call indicator. All the entries are then considered old and kept in the caller ID log.

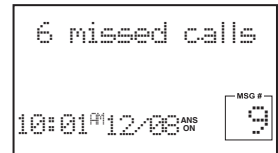
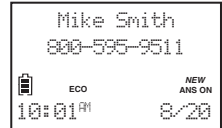
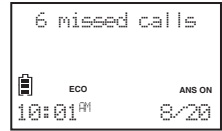

Review the caller ID log

Review the caller ID log to find out who called, to return the call, or to copy the caller's name and number into your directory.

1. Press **CID** on the handset or tap **CID** on the telephone base when the phone is not in use. The screen displays **Entries in CID XXX** for a few seconds.
2. Press **▼** or **▲** on the handset or tap **▼** or **▲** on the telephone base to browse.

-OR-

1. Press **MENU** on the handset when the phone is not in use.
2. Press **▼** or **▲** to scroll to **Caller ID log**, then press **SELECT**.
3. Press **SELECT** to choose **Review**. Then the handset displays **Entries in CID XXX** for a few seconds.
4. Press **▼** or **▲** to browse. You hear a double beep when the list reaches the beginning or end of the caller ID log.

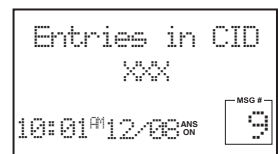
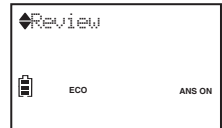
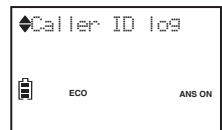

Caller ID

View dialing options

Although the caller ID log entries received have 10 digits (the area code plus the seven-digit number), in some areas, you may need to dial only the seven digits, or 1 plus the seven digits, or 1 plus the area code plus the seven digits. You can change the number of digits that you dial from the caller ID log and store the new number to the directory.

While reviewing the caller ID log, press **#**_{quiet} (pound key) on the handset or **#** (pound key) on the telephone base repeatedly to display different dialing options for local and long distance numbers before dialing or saving the telephone number in the directory.

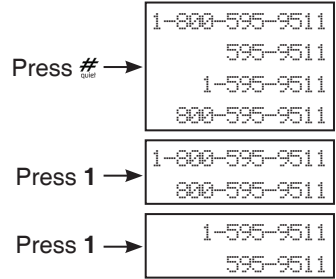

Press **1** repeatedly if you need to add or remove 1 in front of the telephone number before dialing or saving it in the directory.

When the number is displayed in the correct format for dialing, press **TALK** or **»** on a handset, or **»** on the telephone base to dial.



Caller ID

Dial a caller ID log entry

1. Search for the desired caller ID log entry (see **Review the caller ID log** on page 39).
2. When the desired entry displays, press  or  on a handset, or  on the telephone base to dial.

Save a caller ID log entry to the directory

1. Use the handset to search for the desired caller ID log entry (see **Review the caller ID log** on page 39).
2. When the desired entry displays, press **SELECT**. Then the handset displays **Edit number**.
3. Use the dialing keys to edit the number.
 - Press **▼** or **▲** to move the cursor to the left or right.
 - Press **DELETE** to backspace and erase a digit.
 - Press and hold **DELETE** to erase the entire entry.
 - Press and hold **PAUSE** to insert a dialing pause (a **P** appears).
4. Press **SELECT** to move to the name. The handset displays **Edit name**.
5. Use the dialing keys to add or edit the name.
 - Press **▼** or **▲** to move the cursor to the left or right.
 - Press **DELETE** to erase a character.
 - Press and hold **DELETE** to erase all characters.
6. Press **SELECT** when done and the handset shows **Saved**.

note

- If the new directory has the same number as an existing directory entry, the handset displays **Number repeated** and returns to previous screen.
- When you try to save a caller ID entry without any caller ID information, the handset displays **Unable to save**.

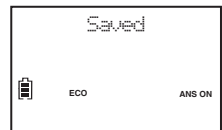
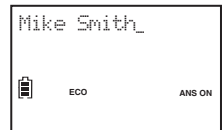
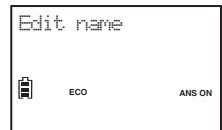
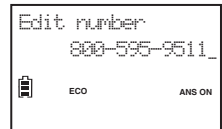

Caller ID

Delete caller ID log entries

To delete one entry:

1. Search for the desired caller ID log entry (see **Review the caller ID log** on page 39).
2. Press **DELETE** on the handset to delete the displayed entry.

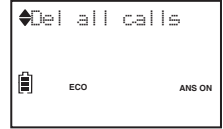

To delete all entries:

1. Press **MENU** when the phone is not in use.
2. Press **▼** or **▲** to scroll to **◆Caller ID log**, then press **SELECT**.
3. Press **▼** or **▲** to scroll to **◆Del all calls**, then press **SELECT**.
4. When the screen shows **Delete all?**, press **SELECT** to delete all caller ID log entries. You hear a confirmation tone.



Caller ID log screen messages

Displays:	When:
PRIVATE NAME	The caller is blocking the name.
PRIVATE NUMBER	The caller is blocking the telephone number.
PRIVATE CALLER	The caller is blocking the name and number.
UNKNOWN NAME	This caller's name is unavailable.
UNKNOWN NUMBER	This caller's number is unavailable.
UNKNOWN CALLER	No information is available about this caller.

Answering system settings

Answering system

Use the answering system menu of a cordless handset to turn on or off the answering system or message alert tone, set up the announcement message, activate the call screening, or change the number of rings, remote access code or message recording time.



Announcement

The telephone is preset with a greeting that answers calls with, *“Hello. Please leave a message after the tone.”* You can use this preset announcement, or replace it with your own.

Record your own announcement

You can record an announcement up to 90 seconds, but any announcement shorter than two seconds will not be recorded.

1. Press **MENU** when the phone is not in use.
2. Press ▼ or ▲ to scroll to ◆**Answering sys**, then press **SELECT**.
3. Press **SELECT** again to select ◆**Announcement**. The system announces, *“To play, press 2. To record, press 7.”*
4. Press **7** to record an announcement. The system announces, *“Record after the tone. Press 5 when you are done.”*
5. After the tone, speak towards the microphone.
6. Press **5** when done. The handset returns to the previous menu.

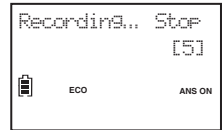
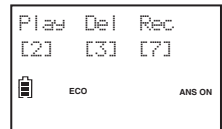
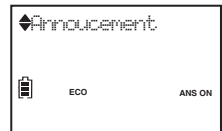

Play your announcement

1. Press **MENU** when the phone is not in use.
2. Press ▼ or ▲ to scroll to ◆**Answering sys**, then press **SELECT**.
3. Press **SELECT** again to choose ◆**Announcement**. The system announces, *“To play, press 2. To record, press 7.”*
4. Press **2** to play the current announcement.

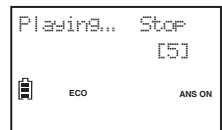
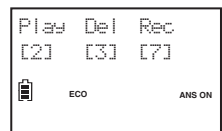

Answering system settings

Delete your announcement

1. Press **MENU** when the phone is not in use.
2. Press ▼ or ▲ to scroll to **◆Answering sys**, then press **SELECT**.
3. Press **SELECT** again to choose **◆Announcement**. The system announces, “*To play, press 2. To record, press 7.*”
4. Press **3** or **DELETE** to delete your recorded announcement. The handset displays **Annc deleted**. You hear a confirmation tone.

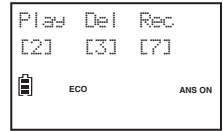

note

When your announcement is deleted, calls are answered with the preset announcement.

Answer on/off

The answering system must be turned on to answer and record messages. When the answering system is turned on, **ANS ON** displays on the handset and the telephone base.

1. Press **MENU** when the phone is not in use.
2. Press ▼ or ▲ to scroll to **◆Answering sys**, then press **SELECT**.
3. Press ▼ or ▲ to scroll to **◆Answer on/off**, then press **SELECT**.
4. Press ▼ or ▲ to choose **◆Answer: On** or **◆Answer: Off**, then press **SELECT** to confirm. You hear a confirmation tone.

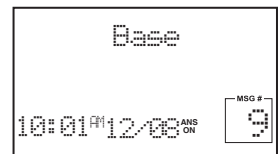
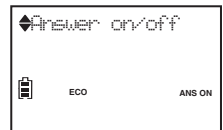
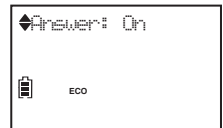
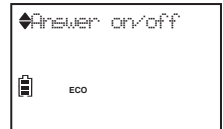

Answering system settings

Call screening

Use this feature to choose whether incoming messages can be heard on while they are being recorded.

1. Press **MENU** when the phone is not in use.
2. Press ▼ or ▲ to scroll to **◆Answering sys**, then press **SELECT**.
3. Press ▼ or ▲ to scroll to **◆Ans sys setup**, then press **SELECT**.
4. Press **SELECT** to select **◆Call screening**.
5. Press ▼ or ▲ choose **◆Screening: On** or **◆Screening: Off**.
6. Press **SELECT** to save and you hear a confirmation tone.

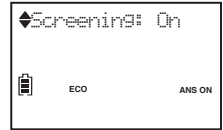
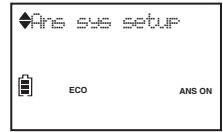

Number of rings

You can choose two, three, four, five or six rings, or toll saver. With toll saver selected, the answering system answers after two rings if you have new messages, or after four rings when there are no new messages. This enables you to check for new messages and avoid paying long distance charges when calling from out of your local area.

1. Press **MENU** when the phone is not in use.
2. Press ▼ or ▲ to scroll to **◆Answering sys**, then press **SELECT**.
3. Press ▼ or ▲ to scroll to **◆Ans sys setup**, then press **SELECT**.
4. Press ▼ or ▲ to scroll to **◆# of rings**, then press **SELECT**.
5. Press ▼ or ▲ to choose **◆6**, **◆5**, **◆4**, **◆3**, **◆2** or **◆Toll saver**.
6. Press **SELECT** to save and you hear a confirmation tone.

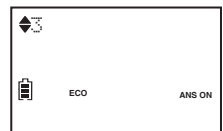
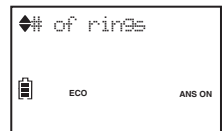

note

If you subscribe to voicemail service from your telephone service provider, see **Answering system and voicemail** on page 48.

Answering system settings

Remote access code

A two-digit security code is required to access the answering system remotely from any touch-tone telephone. The preset code is **19**. You can set the code from **00** to **99**.

1. Press **MENU** when the phone is not in use.
2. Press ▼ or ▲ to scroll to **◆Answering sys**, then press **SELECT**.
3. Press ▼ or ▲ to scroll to **◆Ans sys setup**, then press **SELECT**.
4. Press ▼ or ▲ to scroll to **◆Remote code**, then press **SELECT**.
5. Use the dialing keys to enter a two-digit number.

-OR-

Press ▼ or ▲ to scroll to a desired two-digit number.

6. Press **SELECT** to save and you hear a confirmation tone.



Message alert tone

When the message alert tone is set to on, and there is at least one new message, the telephone base beeps every 10 seconds. The message alert tone is preset to off. There is no audible alert at the handset.

1. Press **MENU** when the phone is not in use.
2. Press ▼ or ▲ to scroll to **◆Answering sys**, then press **SELECT**.
3. Press ▼ or ▲ to scroll to **◆Ans sys setup**, then press **SELECT**.
4. Press ▼ or ▲ to scroll to **◆Msg alert tone**, then press **SELECT**.
5. Press ▼ or ▲ to choose **◆Tone: On** or **◆Tone: Off**.
6. Press **SELECT** to save and you hear a confirmation tone.

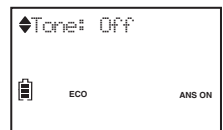
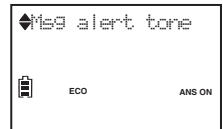

note

The answering system must be turned on for the message alert tone to be functional.

Answering system settings

Recording time

You can set the recording time limit for each incoming message. The recording time is preset to three minutes.



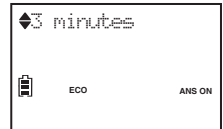

1. Press **MENU** when the phone is not in use.
2. Press ▼ or ▲ to scroll to **◆Answering sys**, then press **SELECT**.
3. Press ▼ or ▲ to scroll to **◆Ans sys setup**, then press **SELECT**.
4. Press ▼ or ▲ to scroll to **◆Recording time**, then press **SELECT**.
5. Press ▼ or ▲ to choose **◆3 minutes**, **◆2 minutes** or **◆1 minute**.
6. Press **SELECT** to save and you hear a confirmation tone.



Answering system operation

Answering system and voicemail

Your telephone has separate indicators for two different types of voice messages: those left on its built-in digital answering system and those left with your telephone service provider's voicemail (fees may apply). Your telephone's built-in digital answering system messages and voicemail messages are separate. Each alerts you to new messages differently.

- If  on the telephone base flashes and **XX new messages** displays on the handset and the telephone base, there are new messages in the built-in answering system. To listen to the messages recorded on your digital answering system, tap  on the telephone base. To listen to messages with a handset, see **To play messages on the handset** on page 51.
- If  and **New voicemail** display on the handset and the telephone base, your telephone service provider is indicating that it has new voicemail for you. To listen to your voicemail, press and hold **1**  on your handset or **1**  on the telephone base. See **Voicemail number** on page 15 to set your voicemail number.

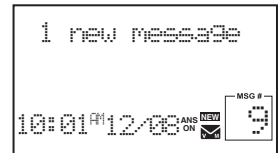

Some telephone service providers bundle or combine multiple services like voicemail and call waiting, so you may not be aware that you have voicemail. To check what services you have and how to access them, contact your telephone service provider.

To use your voicemail service rather than your answering system, turn off your answering system. To use your answering system rather than your voicemail service, contact your telephone service provider to deactivate your voicemail service.

Using the answering system and voicemail together

You can also use your telephone answering system and voicemail together by setting your built-in answering system to answer before voicemail answers as described below. To learn how to program your voicemail settings, contact your telephone service provider. Then, if you are on a call, or if the answering system is busy recording a message and you receive another call, the second caller can leave a voicemail message.

Set your answering system to answer calls at least two rings earlier than your voicemail is set to answer. For example, if your voicemail answers after six rings, set your answering system to answer after four rings. Some voicemail providers may program the delay before answering calls in seconds instead of rings. In this case, allow six seconds per ring when determining the appropriate setting.

Answering system operation

Message capacity

The answering system can record and store up to 59 messages. Each message can be up to three minutes in length, depending on the recording time set (see page 47). The total storage capacity for the announcement, messages and memos is approximately 14 minutes. The actual recording time depends on individual message characteristics. Messages remain available for replay until you delete them.

New message indication

The ►/■ light on the telephone base flashes and **XX new messages** displays on the handset and telephone base when there are new answering system messages.

If the message alert tone is turned on, the telephone base beeps every 10 seconds when there are messages that have not been reviewed.



Call screening

To screen a call at the telephone base:

If the answering system and call screening are on, the announcement and the incoming message broadcast at the telephone base while the call is answered by the answering system.

Options while a message is being recorded:

- Tap **VOL-** or **VOL+** to adjust the call screening volume.
- Tap **VOL-** or **VOL+** to temporarily turn on the call screening if the call screening is set to off.
- Tap ►/■ to temporarily turn on or off the call screening.

To screen a call at the handset



If the answering system is on and recording a message, the handset shows **To screen call press [SELECT]**. Press **SELECT** to screen the call on your handset. The handset shows **Screening...**

Options while a message is being recorded:

- Press ▼/**VOLUME** or ▲/**VOLUME** to adjust the call screening volume.
- Press ◀ to switch between the speakerphone and the handset earpiece.

Answering system operation

Call intercept

If you want to talk to the caller whose message is being recorded, press  or  on the handset, or  on the telephone base.

Temporarily turn off the message alert tone

If the message alert tone is turned on (see page 46), the telephone base beeps every 10 seconds when there are new or missed messages. Pressing any telephone base key (except /FIND HANDSET) temporarily silences the message alert tone.

The message alert tone resumes when you receive a new message.

Answering system operation

Message playback

When playback begins, the total number of old or new messages is announced, and it displays the number of old and new messages.

Before each message, you hear the day and time of the recording. If the date and time are not set, you hear, *"Time and date not set,"* before playback.

After the last message, you hear, *"End of messages."*

If the recording time is less than three minutes, you hear, *"Less than three minutes to record."*

If there are no recorded messages, the screen shows **No message** and you hear, *"You have no message."*

To play messages at the telephone base:

- Tap **▶/■** when the phone is not in use.

Options during playback:

- Press **VOL-** or **VOL+** to adjust the message playback volume.
- Press **2▶▶** to skip to the next message.
- Press **◀◀4** to repeat the message. Press **◀◀4** twice to listen to the previous message.
- Press **3x** to delete the playing message.
- Tap **▶/■** to stop the playback.

To play messages on the handset:

1. Press **MENU** when the phone is not in use.
2. Press **SELECT** to choose **▶Play messages**.

Options during playback:

- Press **▼/VOLUME** or **▲/VOLUME** to adjust the message playback volume.
- Press **6** to skip to the next message.
- Press **4** to repeat the message. Press **4** twice to hear the previous message.
- Press **3** to delete the playing message.
- Press **OFF** to stop the playback.
- Press **◀))** to switch between the speakerphone and the handset earpiece.

note

Only one device can access the answering system at a time.

Answering system operation

Delete all old messages

You can only delete old (reviewed) messages. You cannot delete new messages until you review them. You cannot retrieve deleted messages.

1. Press **MENU** when the phone is not in use.
2. Press ▼ or ▲ to scroll to **◆Answering sys**. Press **SELECT**.
3. Press ▼ or ▲ to scroll to **◆Delete all old**, then press **SELECT**. The handset shows **Delete all msg?**
4. Press **SELECT** again to confirm. The handset displays **Deleting...** then **No old messages** and then returns to the previous menu. You hear a confirmation tone.

Record, play and delete memos

Memos are your own recorded messages used as reminders for yourself or others using the same answering system. You can record your own memos using the handset. Play and delete them in the same way as incoming messages (see **Message playback** on page 51).

To record a memo:

1. Press **MENU** when the phone is not in use.
2. Press ▼ or ▲ to scroll to **◆Answering sys**, then press **SELECT**.
3. Press ▼ or ▲ to scroll to **◆Record memo**, then press **SELECT**.
4. The system announces, *“Record after the tone. Press 5 when you are done.”* After the tone, speak towards the microphone.
5. Press **5** to stop recording. The system announces, *“Recorded.”*

note

- *“Memory is full”* is announced if you record a memo when the memory is full.
- Each memo can be up to three minutes in length.
- Memos shorter than two seconds are not recorded.

Answering system operation

Remote access

A two-digit security code is required to access the answering system remotely from any touch-tone telephone. The preset code is **19**. See **Remote access code** on page 46 to change it.

1. Dial your telephone number from any touch-tone telephone.
2. When the system plays your announcement, enter the two-digit security code.
3. You can enter one of the following remote commands.

Command	Description
1	Play all messages.
2	Play new messages.
3	Delete the current message (during playback).
33	Delete all old messages.
4	Repeat the current message (during playback).
5	Stop.
*5	Hear a list of remote commands.
6	Skip to the next message (during playback).
*7	Record a new announcement.
8	End the call.
0	Turn the answering system on or off.

4. Hang up or press **8** to end the call.

note

- If you do not press any keys after you enter the remote access code, all new messages play. If there are no new messages, all old messages play.
- Once the new messages have played, the telephone announces the help menu options. If you do not press any key within 20 seconds, the remote access call automatically disconnects.
- When the answering system is turned off, the telephone answers after 10 rings, and announces, *"Please enter your remote access code."*
- When the answering system memory is full, the telephone announces, *"Memory is full. Enter the remote access code."*

Appendix

Expand your telephone system

The cordless handset provided within your product package is already registered as **HANDSET 1**.

This telephone system accommodates up to five handsets. You can add new handsets (**LS6005/LS6005-13/LS6005-15/LS6500-16/LS6005-17**, purchased separately) to your telephone base. Each new handset must be registered with the telephone base before use. Additional handsets registered to the telephone system are assigned numbers in the sequential order.

Add and register a handset

When first purchased, each expansion handset alternately shows **To register HS...** and **...see manual**. The new handset should be charged without interruption for at least 30 minutes before registering it to the telephone base.

To register a handset:

1. At the bottom of the telephone base, press and hold ***/FIND HANDSET** for about four seconds until it shows **Registering...**

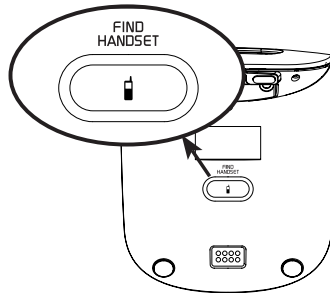

2. On the cordless handset, press **#** then it shows **Registering...** Both the telephone base and cordless handset show **Registered** and you hear a beep when the registration process completes. The registration process takes about 60 seconds to complete.

If registration fails, the handset displays **Failed**. Try the registration process again.

note

- You cannot register a handset if any other system handset is in use.
- If you have not set the date and time for the telephone system, the handset will prompt you to set the date and time after it is registered to the base. To skip setting, press **CANCEL**.

Appendix

Deregister handsets

If you want to replace a handset, or reassign the designated handset number of a registered handset, you must deregister all handsets that are registered to the telephone base. Then register each handset individually.

To make deregistration easier, read all of the instructions on this page before you begin.

To deregister all handsets:

1. Press and hold **FIND HANDSET** on the telephone base for about 10 seconds until the telephone base displays **De-Register?**
2. Immediately press **FIND HANDSET** again. The telephone base displays **Please wait** and you hear a confirmation tone.
3. All handsets alternately show **To register HS...** and **...see manual** when the deregistration process completes. The deregistration process takes about 10 seconds to complete.

To register the handset(s) to the telephone base again, follow the registration instructions on the previous page.

note

- You cannot deregister all handsets if any other system handset is in use.
- If deregistration fails, you may need to reset the system and try again. To reset, unplug the power from the telephone base and plug it back in.
- Even if the battery is depleted, you can still deregister all handsets by following the steps above. After the handset is charged for at least 10 minutes, the handset alternately shows **To register HS...** and **...see manual**.

Appendix

Screen messages

Call log empty	There are no caller ID log entries.
Calling base	The handset is calling the telephone base (for intercom calls). The handset is transferring an outside call to the telephone base.
Calling HS X	The handset is calling another system handset.
Contact deleted	A directory entry is deleted.
Directory empty	There are no directory entries.
Directory full	The directory is full. You cannot save any new entries unless you delete some current entries.
Ended	You have just ended a call.
Failed	The handset fails to register to the telephone base.
HS X is calling	Another system handset is calling (for intercom calls).
Incoming call	There is a call coming in.
Intercom	The system device is on an intercom call.
Intercom ended	The intercom call has just ended.
Intercom to	You have started the intercom process, and need to enter the number of the system device you wish to call.
Line in use	A system device or another telephone on the same line is in use.
Low battery	The handset battery needs to be recharged.
Microphone on	The mute function is turned off and the other party can hear you.
Muted	The microphone is off. The other party cannot hear you.
New voicemail	There are new voicemail messages from your telephone service provider.
No battery	The handset in the telephone base or handset charger has no battery installed.
No line	There is no telephone line connection.
Not available	Someone else is using the directory, caller ID log, or answering system.
Number repeated	The telephone number you have entered is already in the directory.
Out of range or no fur at base	The telephone base has lost power, or the handset is out of range.
Phone	The handset/telephone base is on a call.
Put in charger	The battery is very low. Put the handset in the telephone base for recharging.

Appendix



Screen messages

Quiet mode off	The quiet mode is off.
Quiet mode on	The quiet mode is on.
Rec mem full	The system recording time is full.
Ringer muted	The ringer is off temporarily during an incoming call.
Ringer off	The ringer is turned off.
Saved	Your selection has been saved.
Speaker	The speakerphone is in use.
Transferred	You have transferred an outside call to another system device.
Unable to call	The handset is out of range while on a call. Failed phone call (the telephone line is in use). Failed intercom or conference call (there are already two handsets being used).
Unable to save	You tried to save a caller ID entry with no caller ID information.
XX missed calls	There are new calls in the caller ID log.
XX new messages	There are new messages in the answering system.
** Paging **	The telephone base is paging the handset.







Appendix

Handset and telephone base indicators



Telephone base lights

CHARGE	On when the handset is charging in the telephone base.
	On when the telephone base speakerphone is in use.
	Flashes when there are new memos or messages in the answering system.

Handset icons

	The battery icon flashes when the battery is low and needs charging.
	The battery icon animates when the battery is charging.
	The battery icon becomes solid when the battery is fully charged.
	There are new voicemail received from your telephone service provider.
	The handset ringer is off.
	The message number currently playing and the total number of new messages recorded.
ANS ON	The answering system is turned on.
ECO	The ECO mode activates automatically to reduce power consumption when the handset is within range from the telephone base.
NEW	The caller ID entry you are reviewing is new in the caller ID log.

Telephone base icons

	There are new voicemail received from your telephone service provider.
NEW	The caller ID entry you are reviewing is new in the caller ID log.
ANS ON	The answering system is turned on.
	The message number currently playing or the total number of messages recorded.

Appendix

Battery

It takes up to 11 hours for the battery to be fully charged. When it is fully charged, you can expect the following performance:

Operation	Operating time
While in handset use (talking*)	Up to seven hours
While in speakerphone mode (talking*)	Up to three hours
While not in use (standby**)	Up to five days

* Operating times vary depending on your actual use and the age of the battery.

** Handset is not charging or in use.

The battery needs charging when:

- A new battery is installed in the handset.
- The handset beeps.
- A battery is properly installed and the screen is blank.
- **Low battery** or **Put in charger** displays on the handset screen.

CAUTION:

To reduce the risk of fire or injury, read and follow these instructions:

- Use only the batteries provided or equivalent. To order a replacement, visit our website at www.vtechphones.com or call 1 (800) 595-9511. In Canada, go to www.vtechcanada.com or dial 1 (800) 267-7377.
- Do not dispose of the batteries in a fire. Check with local waste management codes for special disposal instructions.
- Do not open or mutilate the batteries. Released electrolyte is corrosive and may cause burns or injury to the eyes or skin. The electrolyte may be toxic if swallowed.
- Exercise care in handling batteries in order not to create a short circuit with conductive materials.
- Charge the batteries provided with or identified for use with this product only in accordance with the instructions and limitations specified in this manual.
- Observe proper polarity orientation between the battery and metallic contacts.
- To prevent fire or shock hazard, do not expose this product to water or any type of moisture.

Appendix

Troubleshooting

If you have difficulty with your telephone, please try the suggestions below. For customer service, visit our website at www.vtechphones.com or call 1 (800) 595-9511. In Canada, go to www.vtechcanada.com or dial 1 (800) 267-7377.

My telephone doesn't work at all.

- Make sure the power cord is securely plugged in.
- Make sure you plug the battery connector securely into the cordless handset.
- Make sure you plug the telephone line cord securely and firmly into the telephone base and the telephone wall jack.
- Unplug the electrical power to the telephone base. Wait for approximately 15 seconds, then plug it back in. Allow up to one minute for the cordless handset and telephone base to synchronize.
- Charge the battery in the cordless handset for up to 11 hours.
- If the battery is completely depleted, charge the handset for at least 30 minutes before use (page 4).
- Reset the telephone base. Unplug the electrical power. Wait for approximately 15 seconds, then plug it back in. Allow up to one minute for the cordless handset and telephone base to reset.
- You may need to purchase a new battery. Please refer to **Handset battery installation** (page 3) and **Handset battery charging** (page 4).
- Disconnect the telephone base from the telephone wall jack and plug in a working telephone. If the other telephone does not work, the problem is probably in the wiring or telephone service. Contact your telephone service provider.

There is no dial tone.

- Try all the suggestions above.
- Move the cordless handset closer to the telephone base. You may have moved out of range.
- If the previous suggestions do not work, disconnect the telephone base from the telephone jack and connect to a different phone. If there is no dial tone on that phone either, the problem is in your wiring or telephone service. Contact your telephone service provider.
- Your line cord may be defective. Try installing a new line cord.

Appendix

Troubleshooting

I cannot dial out.

- Try all the suggestions above.
- Make sure you have a dial tone before dialing. The cordless handset may take a second or two to find the telephone base and produce a dial tone. This is normal. Wait an extra second before dialing.
- Eliminate any background noise. Noise from a television, radio or other appliances might cause the phone to not dial out properly. If you cannot eliminate the background noise, first try muting the cordless handset before dialing, or dialing from another room with less background noise.
- If other phones in your home are having the same problem, contact your telephone service provider (charges may apply).

My cordless handset isn't performing normally.

- Make sure you plug the power cord securely into the telephone base. Plug the power adapter into a different, working electrical outlet without a wall switch.
- Move the cordless handset closer to the telephone base. You may have moved out of range.
- Reset the telephone base. Unplug the electrical power. Wait for 15 seconds then plug it back in. Allow up to one minute for the cordless handset and telephone base to reset.
- Other electronic products such as HAM radios and other DECT phones can cause interference with your cordless phone. Try installing your phone as far away as possible from these types of electronic devices.

Out of range or no pwr at base appears on my cordless handset.

- Ensure you plug the telephone base in properly and the power is on.
- Place the cordless handset closer to the telephone base for synchronization.
- Move the cordless handset closer to the telephone base. You may have moved out of range.
- Reset the telephone base. Unplug the electrical power. Wait for 15 seconds then plug it back in. Allow up to one minute for the cordless handset and telephone base to reset.
- Other electronic products such as HAM radios and other DECT phones can cause interference with your cordless phone. Try installing your phone as far away as possible from these types of electronic devices.

Appendix

Troubleshooting

The battery does not charge in the handset, or the handset battery does not accept charge.

- If the cordless handset is in the telephone base and the charge light is not on, refer to **The charge light is off** (page 64).
- Charge the battery in the cordless handset for at least 11 hours. For optimum daily performance, return the cordless handset to the telephone base when not in use.
- If the battery is completely depleted, charge the handset for at least 30 minutes before use (page 4).
- You may need to purchase a new battery. Please refer to **Handset battery installation** (page 3) and **Handset battery charging** (page 4).

I get noise, static, or weak signals even when I'm near the telephone base.

- If you subscribe to high-speed Internet service (DSL - digital subscriber line) through your telephone line, you must install a DSL filter between the telephone line cord and the telephone wall jack (page 2). The filter prevents noise and caller ID problems as a result of DSL interference. Contact your DSL service provider for more information about DSL filters.
- You may be able to improve the performance of your cordless phone by installing your new telephone base as far as possible from any other existing cordless telephone system that may already be installed.
- Other electronic products such as HAM radios and other DECT phones can cause interference with your cordless phone. Try installing your phone as far away as possible from these types of electronic devices.
- Do not install this phone near a microwave oven or on the same electrical outlet. You may experience decreased performance while the microwave oven is operating.
- If you plug your phone in with a modem or a surge protector, plug the phone (or modem/surge protector) into a different location. If this does not solve the problem, relocate your phone or modem farther apart from one another, or use a different surge protector.
- Relocate your phone to a higher location. The phone may have better reception in a high area.
- If other phones in your home are having the same problem, contact your telephone service provider (charges may apply).

Appendix

Troubleshooting

I experience poor sound quality when using the handset speakerphone.

- For increased sound quality while using the handset speakerphone, place the handset on a flat surface with the dialing keys facing up.

I hear other calls while using my phone.

- Disconnect the telephone base from the telephone jack, and plug in a different telephone. If you still hear other calls, call your telephone service provider.

The telephone does not ring when there is an incoming call.

- Make sure that the ringer is not off. Refer to **Handset ringer volume** and **Telephone base ringer volume** on page 11 in this user's manual.
- Make sure you plug in the telephone line cord securely into the telephone base and the telephone jack. Make sure you plug in the power cord securely.
- The cordless handset may be too far from the telephone base.
- Charge the battery in the cordless handset for at least 11 hours. For optimum daily performance, return the cordless handset to the telephone base when not in use.
- You may have too many extension phones on your telephone line to allow all of them to ring simultaneously. Try unplugging some of the other phones.
- The layout of your home or office might be limiting the operating range. Try moving the telephone base to another location, preferably to a higher location.
- If other phones in your home are having the same problem, contact your telephone service provider (charges may apply).
- Test a working phone at the phone jack. If another phone has the same problem, contact your telephone service provider (charges may apply).
- Other electronic products such as HAM radios and other DECT phones can cause interference with your cordless phone. Try installing your phone as far away as possible from these types of electronic devices.
- Remove and install the battery again. Place the cordless handset in the telephone base or handset charger. Wait for the cordless handset to reestablish its connection with the telephone base. Allow up to one minute for this to take place.
- Your line cord may be defective. Try installing a new line cord.

Appendix

Troubleshooting

My calls cut in and out while I'm using my cordless handset.

- Other electronic products such as HAM radios and other DECT phones can cause interference with your cordless phone. Try installing your phone as far away as possible from these types of electronic devices.
- Do not install this phone near a microwave oven or on the same electrical outlet. You may experience decreased performance while the microwave oven is operating.
- If you plug your phone in with a modem or surge protector, plug the phone (or modem/surge protector) into a different location. If this does not solve the problem, relocate your phone or modem farther apart from one another, or use a different surge protector.
- Relocate your telephone base to a higher location. The phone may have better reception when installed in a high area.
- If other phones in your home are having the same problem, contact your telephone service provider (charges may apply).

The charge light is off.

- Make sure you plug the power and line cords in correctly and securely.
- Unplug the electrical power. Wait for 15 seconds, then plug it back in. Allow up to one minute for the cordless handset and telephone base to reset.
- Clean the charging contacts on the cordless handset and telephone base each month with a pencil eraser or cloth.

My caller ID isn't working properly.

- Caller ID is a subscription service. You must subscribe to this service from your telephone service provider for this feature to work on your phone.
- The caller must be calling from an area that supports caller ID.
- Both your and your caller's telephone service providers must use caller ID compatible equipment.
- If you subscribe to high-speed Internet service (DSL - digital subscriber line) through your telephone line, you must install a DSL filter between the telephone line cord and the telephone wall jack (page 2). The filter prevents noise and caller ID problems resulting from DSL interference. Contact your DSL service provider for more information about DSL filters.

Appendix

Troubleshooting

My telephone does not receive caller ID when on a call.

- Make sure you subscribe to caller ID with call waiting features from your telephone service provider. Caller ID feature works only if both you and the caller are in areas offering caller ID service, and if both telephone service providers use compatible equipment.

The messages on the answering system are incomplete.

- If a caller leaves a very long message, part of it may be lost when the system disconnects the call after the preset recording time.
- If the caller pauses for too long, the system stops recording and disconnects the call.
- If memory on the answering system becomes full during a message, the system stops recording and disconnects the call.
- If the caller's voice is very soft, the system may stop recording and disconnect the call.

The messages are very difficult to hear.

- Tap **VOL+** on the telephone base, or press **▲/VOLUME** on the cordless handset to increase the listening volume.

The answering system does not answer after the correct number of rings.

- Make sure that the answering system is on. **ANS ON** should show on the handset and the telephone base.
- If toll saver is activated, the number of rings changes to two when you have new messages stored (page 45).
- If the memory is full or the system is off, the system will answer after 10 rings.
- In some cases, the answering system is affected by the ringing system used by your telephone service provider.
- If you subscribe to voicemail service, change the number of rings so that your answering system answers before your voicemail answers. To determine how many rings activate your voicemail, contact your telephone service provider.
- If there is a fax machine connected to the same telephone line, try disconnecting the fax machine. If that solves the problem, consult your fax machine documentation for information on compatibility with answering systems.

Appendix

Troubleshooting

The telephone does not respond to remote commands.

- Make sure to enter your remote access code correctly (page 53).
- Make sure you are calling from a touch-tone phone. When you dial a number, you should hear tones. If you hear clicks, the phone is not a touch-tone telephone and cannot activate the answering system.
- The answering system may not detect the remote access code while your announcement is playing. Try waiting until the announcement is over before entering the code.
- There may be interference on the phone line you are using. Press dialing keys firmly.

The answering system does not record messages.

- Make sure the answering system is on. **ANS ON** should show on the handset and the telephone base.
- Make sure the memory of the answering system is not full.
- If you subscribe to voicemail service, change the number of rings so that your answering system answers before your voicemail answers. To determine how many rings activate your voicemail, contact your telephone service provider.
- If there is a fax machine connected to the same telephone line, try disconnecting the fax machine. If that solves the problem, consult your fax machine documentation for information on compatibility with answering systems.

The system announces *“Time and day not set.”*

- You need to reset the system clock (page 13).

The outgoing announcement is not clear.

- When you record your announcement, make sure you speak in a normal tone of voice, about nine inches from the handset or telephone base.
- Make sure there is no background noise (TV, music, etc.) while recording.

New voicemail and show and I don't know why.

- Your telephone has both a built-in answering system and voicemail indication. If **New voicemail** and  appear, then your telephone has received a signal from your telephone service provider that you have a voicemail message waiting for you to retrieve from them. Contact your telephone service provider for more information on how to access your voicemail.

Appendix

Troubleshooting

I cannot retrieve voicemail messages.

- Your telephone has both a built-in answering system and voicemail indication. They are independent features and each alerts you to new messages differently. If you subscribe to voicemail service from your telephone service provider, contact your telephone service provider for more information on how to access your voicemail.

I subscribe to a nontraditional telephone service that uses my computer to establish connections, and my telephone doesn't work.

- Make sure your computer is powered on.
- Make sure your Internet connection is working properly.
- Make sure that the software is installed and running for your nontraditional telephone service.
- Make sure to plug your USB telephone adapter into a dedicated USB port on your computer. Do not plug into a multiple port USB hub (USB splitter) that is not powered.
- In a few rare instances, the USB port on your computer may not have enough power. In these instances, try using a USB hub with its own external power supply.
- If you are using a firewall, it may prevent access to your nontraditional telephone service provider. Contact your service provider for more information.

I accidentally changed the LCD language to French or Spanish, and I don't know how to change it back to English.

- While the handset is in idle mode, press **MENU** and then enter *** 364 #**.
- While the handset is on a call, press **MENU** and then enter *** 364 #**. Then press **OFF** to exit the menu.

Common cure for electronic equipment.

If the telephone does not seem to be responding normally, do the following (in the order listed):

1. Disconnect the power to the telephone base.
2. Disconnect the cordless handset battery.
3. Wait a few minutes.
4. Connect power to the telephone base.
5. Install the battery again, and place the cordless handset in the telephone base.
6. Wait for the cordless handset to reestablish its connection with the telephone base. Allow up to one minute for this to take place.

Appendix

Important safety instructions

When using your telephone equipment, basic safety precautions should always be followed to reduce the risk of fire, electric shock and injury, including the following:

1. Read and understand all instructions.
2. Follow all warnings and instructions marked on the product.
3. Unplug this product from the wall outlet before cleaning. Do not use liquid or aerosol cleaners. Use a damp cloth for cleaning.
4. Do not use this product near water such as near a bath tub, wash bowl, kitchen sink, laundry tub or swimming pool, or in a wet basement or shower.
5. Do not place this product on an unstable table, shelf, stand or other unstable surfaces.
6. Slots and openings in the back or bottom of the telephone base and handset are provided for ventilation. To protect them from overheating, these openings must not be blocked by placing the product on a soft surface such as a bed, sofa or rug. This product should never be placed near or over a radiator or heat register. This product should not be placed in any area where proper ventilation is not provided.
7. This product should be operated only from the type of power source indicated on the marking label. If you are not sure of the type of power supply in your home or office, consult your dealer or local power company.
8. Do not allow anything to rest on the power cord. Do not install this product where the cord may be walked on.
9. Never push objects of any kind into this product through the slots in the telephone base or handset because they may touch dangerous voltage points or create a short circuit. Never spill liquid of any kind on the product.
10. To reduce the risk of electric shock, do not disassemble this product, but take it to an authorized service facility. Opening or removing parts of the telephone base or handset other than specified access doors may expose you to dangerous voltages or other risks. Incorrect reassembling can cause electric shock when the product is subsequently used.
11. Do not overload wall outlets and extension cords.
12. Unplug this product from the wall outlet and refer servicing to an authorized service facility under the following conditions:
 - When the power supply cord or plug is damaged or frayed.
 - If liquid has been spilled onto the product.
 - If the product has been exposed to rain or water.
 - If the product does not operate normally by following the operating instructions. Adjust only those controls that are covered by the operation instructions. Improper adjustment of other controls may result in damage and often requires extensive work by an authorized technician to restore the product to normal operation.
 - If the product has been dropped and the telephone base and/or handset has been damaged.
 - If the product exhibits a distinct change in performance.
13. Avoid using a telephone (other than cordless) during an electrical storm. There is a remote risk of electric shock from lightning.
14. Do not use the telephone to report a gas leak in the vicinity of the leak. Under certain circumstances, a spark may be created when the adapter is plugged into the power outlet, or when the handset is replaced in its cradle. This is a common event associated with the closing of any electrical circuit. The user should not plug the phone into a power outlet, and should not put a charged handset into the cradle, if the phone is located in an environment containing concentrations of flammable or flame-supporting gases, unless there is adequate ventilation. A spark in such an environment could create a fire or explosion. Such environments might include: medical use of oxygen without adequate ventilation; industrial gases (cleaning solvents; gasoline vapors; etc.); a leak of natural gas; etc.
15. Only put the handset of your telephone next to your ear when it is in normal talk mode.
16. The power adapters are intended to be correctly oriented in a vertical or floor mount position. The prongs are not designed to hold the plug in place if it is plugged into a ceiling, under-the-table or cabinet outlet.

SAVE THESE INSTRUCTIONS

Appendix

Precautions for users of implanted cardiac pacemakers

Cardiac pacemakers (applies only to digital cordless telephones):

Wireless Technology Research, LLC (WTR), an independent research entity, led a multidisciplinary evaluation of the interference between portable wireless telephones and implanted cardiac pacemakers. Supported by the U.S. Food and Drug Administration, WTR recommends to physicians that:

Pacemaker patients



- Should keep wireless telephones at least six inches from the pacemaker.
- Should NOT place wireless telephones directly over the pacemaker, such as in a breast pocket, when it is turned ON.
- Should use the wireless telephone at the ear opposite the pacemaker.

WTR's evaluation did not identify any risk to bystanders with pacemakers from other persons using wireless telephones.

Operating range

This cordless telephone operates with the maximum power allowed by the Federal Communications Commission (FCC). Even so, this handset and telephone base can communicate over only a certain distance - which can vary with the locations of the telephone base and handset, the weather, and the layout of your home or office.

When the handset is out of range, the handset displays **Out of range OR No pwr at base**.

If there is a call while the handset is out of range, it may not ring, or if it does ring, the call may not connect well when you press . Move closer to the telephone base, then press  to answer the call.

If the handset moves out of range during a telephone conversation, there may be interference. To improve reception, move closer to the telephone base.

ECO mode

This power conserving technology reduces power consumption for optimal battery performance. The ECO mode activates automatically whenever the handset is synchronized with the telephone base.

Appendix

Maintenance

Taking care of your telephone

Your telephone contains sophisticated electronic parts, so it must be treated with care.

Avoid rough treatment

Place the handset down gently. Save the original packing materials to protect your telephone if you ever need to ship it.

Avoid water

Your telephone can be damaged if it gets wet. Do not use the handset outdoors in the rain, or handle it with wet hands. Do not install the telephone base near a sink, bathtub or shower.

Electrical storms

Electrical storms can sometimes cause power surges harmful to electronic equipment. For your own safety, take caution when using electrical appliances during storms.

Cleaning your telephone

Your telephone has a durable plastic casing that should retain its luster for many years. Clean it only with a dry non-abrasive cloth. Do not use dampened cloth or cleaning solvents of any kind.

Remember that electrical appliances can cause serious injury if used when you are wet or standing in water. If the telephone base should fall into water, **DO NOT RETRIEVE IT UNTIL YOU UNPLUG THE POWER CORD AND TELEPHONE LINE CORD FROM THE WALL.** Then remove the telephone by the unplugged cords.

About cordless telephones

- **Privacy:** The same features that make a cordless telephone convenient create some limitations. Telephone calls are transmitted between the telephone base and the cordless handset by radio waves, so there is a possibility that the cordless telephone conversations could be intercepted by radio receiving equipment within range of the cordless handset. For this reason, you should not think of cordless telephone conversations as being as private as those on corded telephones.
- **Electrical power:** The telephone base of this cordless telephone must be connected to a working electrical outlet. The electrical outlet should not be controlled by a wall switch. Calls cannot be made from the cordless handset if the telephone base is unplugged, switched off or if the electrical power is interrupted.
- **Potential TV interference:** Some cordless telephones operate at frequencies that may cause interference to televisions and VCRs. To minimize or prevent such interference, do not place the telephone base of the cordless telephone near or on top of a TV or VCR. If interference is experienced, moving the cordless telephone farther away from the TV or VCR often reduces or eliminates the interference.
- **Rechargeable batteries:** Exercise care in handling batteries in order not to create a short circuit with conducting material such as rings, bracelets and keys. The battery or conductor may overheat and cause harm. Observe proper polarity between the battery and the battery charger.
- **Nickel-metal hydride rechargeable batteries:** Dispose of these batteries in a safe manner. Do not burn or puncture the battery. Like other batteries of this type, if burned or punctured, they could release caustic material which could cause injury.

Appendix

The RBRC® seal

The RBRC® seal on the nickel-metal hydride battery indicates that VTech Communications, Inc. is voluntarily participating in an industry program to collect and recycle these batteries at the end of their useful lives, when taken out of service within the United States and Canada.

The RBRC® program provides a convenient alternative to placing used nickel-metal hydride batteries into the trash or municipal waste, which may be illegal in your area.

VTech's participation in RBRC® makes it easy for you to drop off the spent battery at local retailers participating in the RBRC® program or at authorized VTech product service centers. Please call **1 (800) 8 BATTERY™** for information on Ni-MH battery recycling and disposal bans/restrictions in your area. VTech's involvement in this program is part of its commitment to protecting our environment and conserving natural resources.

RBRC® is a registered trademark of Rechargeable Battery Recycling Corporation.



Appendix

FCC, ACTA and IC regulations

FCC Part 15

This equipment has been tested and found to comply with the requirements for a Class B digital device under Part 15 of the Federal Communications Commission (FCC) rules. These requirements are intended to provide reasonable protection against harmful interference in a residential installation. This equipment generates, uses and can radiate radio frequency energy and, if not installed and used in accordance with the instructions, may cause harmful interference to radio communications. However, there is no guarantee that interference will not occur in a particular installation. If this equipment does cause harmful interference to radio or television reception, which can be determined by turning the equipment off and on, the user is encouraged to try to correct the interference by one or more of the following measures:

- Reorient or relocate the receiving antenna.
- Increase the separation between the equipment and receiver.
- Connect the equipment into an outlet on a circuit different from that to which the receiver is connected.
- Consult the dealer or an experienced radio/TV technician for help.

Changes or modifications to this equipment not expressly approved by the party responsible for compliance could void the user's authority to operate the equipment.

This device complies with Part 15 of the FCC rules. Operation is subject to the following two conditions: (1) this device may not cause harmful interference, and (2) this device must accept any interference received, including interference that may cause undesired operation. Privacy of communications may not be ensured when using this telephone.

To ensure safety of users, the FCC has established criteria for the amount of radio frequency energy that can be safely absorbed by a user or bystander according to the intended usage of the product. This product has been tested and found to comply with the FCC criteria. The handset may be safely held against the ear of the user. The telephone base shall be installed and used such that parts of the user's body other than the hands are maintained at a distance of approximately 20 cm (8 inches) or more.

This Class B digital apparatus complies with Canadian ICES-003.

Appendix

FCC, ACTA and IC regulations

FCC Part 68 and ACTA

This equipment complies with Part 68 of the FCC rules and with technical requirements adopted by the Administrative Council for Terminal Attachments (ACTA). The label on the back or bottom of this equipment contains, among other things, a product identifier in the format US:AAAEQ##TXXXX. This identifier must be provided to your telephone service provider upon request.

The plug and jack used to connect this equipment to premises wiring and the telephone network must comply with applicable Part 68 rules and technical requirements adopted by ACTA. A compliant telephone cord and modular plug is provided with this product. It is designed to be connected to a compatible modular jack that is also compliant. An RJ11 jack should normally be used for connecting to a single line and an RJ14 jack for two lines. See the installation instructions in the user's manual.

The Ringer Equivalence Number (REN) is used to determine how many devices you may connect to your telephone line and still have them ring when you are called. The REN for this product is encoded as the 6th and 7th characters following the US: in the product identifier (e.g., if ## is 03, the REN is 0.3). In most, but not all areas, the sum of all RENs should be five (5.0) or less. For more information, contact your telephone service provider.

This equipment may not be used with Party Lines. If you have specially wired alarm dialing equipment connected to your telephone line, ensure the connection of this equipment does not disable your alarm equipment. If you have questions about what will disable alarm equipment, consult your telephone service provider or a qualified installer.

If this equipment is malfunctioning, it must be unplugged from the modular jack until the problem has been corrected. Repairs to this telephone equipment can only be made by the manufacturer or its authorized agents. For repair procedures, follow the instructions outlined under the Limited warranty.

If this equipment is causing harm to the telephone network, the telephone service provider may temporarily discontinue your telephone service. The telephone service provider is required to notify you before interrupting service. If advance notice is not practical, you will be notified as soon as possible. You will be given the opportunity to correct the problem and the telephone service provider is required to inform you of your right to file a complaint with the FCC. Your telephone service provider may make changes in its facilities, equipment, operation, or procedures that could affect the proper functioning of this product. The telephone service provider is required to notify you if such changes are planned.

If this product is equipped with a corded or cordless handset, it is hearing aid compatible.

If this product has memory dialing locations, you may choose to store emergency telephone numbers (e.g., police, fire, medical) in these locations. If you do store or test emergency numbers, please:

Remain on the line and briefly explain the reason for the call before hanging up.

Perform such activities in off-peak hours, such as early morning or late evening.

Industry Canada

Operation is subject to the following two conditions: (1) this device may not cause harmful interference, and (2) this device must accept any interference, including interference that may cause undesired operation.

The term "IC:" before the certification/registration number only signifies that the Industry Canada technical specifications were met.

The Ringer Equivalence Number (REN) for this terminal equipment is 1.0. The REN is an indication of the maximum number of devices allowed to be connected to a telephone interface. The termination on an interface may consist of any combination of devices subject only to the requirement that the sum of the RENs of all the devices does not exceed five.

This product meets the applicable Industry Canada technical specifications.

Appendix

Limited warranty

What does this limited warranty cover?

The manufacturer of this VTech Product warrants to the holder of a valid proof of purchase (“Consumer” or “you”) that the Product and all accessories provided in the sales package (“Product”) are free from defects in material and workmanship, pursuant to the following terms and conditions, when installed and used normally and in accordance with the Product operating instructions. This limited warranty extends only to the Consumer for Products purchased and used in the United States of America and Canada.

What will VTech do if the Product is not free from defects in materials and workmanship during the limited warranty period (“Materially Defective Product”)?

During the limited warranty period, VTech’s authorized service representative will repair or replace at VTech’s option, without charge, a Materially Defective Product. If we repair the Product, we may use new or refurbished replacement parts. If we choose to replace the Product, we may replace it with a new or refurbished Product of the same or similar design. We will retain defective parts, modules, or equipment. Repair or replacement of the Product, at VTech’s option, is your exclusive remedy. VTech will return the repaired or replacement Products to you in working condition. You should expect the repair or replacement to take approximately 30 days.

How long is the limited warranty period?

The limited warranty period for the Product extends for ONE (1) YEAR from the date of purchase. If VTech repairs or replaces a Materially Defective Product under the terms of this limited warranty, this limited warranty also applies to repaired or replacement Product for a period of either (a) 90 days from the date the repaired or replacement Product is shipped to you or (b) the time remaining on the original one-year warranty; whichever is longer.

What is not covered by this limited warranty?

This limited warranty does not cover:

1. Product that has been subjected to misuse, accident, shipping or other physical damage, improper installation, abnormal operation or handling, neglect, inundation, fire, water or other liquid intrusion; or
2. Product that has been damaged due to repair, alteration or modification by anyone other than an authorized service representative of VTech; or
3. Product to the extent that the problem experienced is caused by signal conditions, network reliability, or cable or antenna systems; or
4. Product to the extent that the problem is caused by use with non-VTech accessories; or
5. Product whose warranty/quality stickers, product serial number plates or electronic serial numbers have been removed, altered or rendered illegible; or
6. Product purchased, used, serviced, or shipped for repair from outside the United States of America or Canada, or used for commercial or institutional purposes (including but not limited to Products used for rental purposes); or
7. Product returned without a valid proof of purchase (see item 2 on the next page); or
8. Charges for installation or set up, adjustment of customer controls, and installation or repair of systems outside the unit.

Appendix

Limited warranty

How do you get warranty service?

To obtain warranty service in the United States of America, please visit our website at www.vtechphones.com or call 1 (800) 595-9511. In Canada, go to www.vtechcanada.com or dial 1 (800) 267-7377.

NOTE: Before calling for service, please review the user's manual - a check of the Product's controls and features may save you a service call.

Except as provided by applicable law, you assume the risk of loss or damage during transit and transportation and are responsible for delivery or handling charges incurred in the transport of the Product(s) to the service location. VTech will return repaired or replaced Product under this limited warranty. Transportation, delivery or handling charges are prepaid. VTech assumes no risk for damage or loss of the Product in transit. If the Product failure is not covered by this limited warranty, or proof of purchase does not meet the terms of this limited warranty, VTech will notify you and will request that you authorize the cost of repair prior to any further repair activity. You must pay for the cost of repair and return shipping costs for the repair of Products that are not covered by this limited warranty.

What must you return with the Product to get warranty service?

1. Return the entire original package and contents including the Product to the VTech service location along with a description of the malfunction or difficulty; and
2. Include a "valid proof of purchase" (sales receipt) identifying the Product purchased (Product model) and the date of purchase or receipt; and
3. Provide your name, complete and correct mailing address, and telephone number.

Other limitations

This warranty is the complete and exclusive agreement between you and VTech. It supersedes all other written or oral communications related to this Product. VTech provides no other warranties for this Product. The warranty exclusively describes all of VTech's responsibilities regarding the Product. There are no other express warranties. No one is authorized to make modifications to this limited warranty and you should not rely on any such modification.

State/Provincial Law Rights: This warranty gives you specific legal rights, and you may also have other rights, which vary from state to state or province to province.

Limitations: Implied warranties, including those of fitness for a particular purpose and merchantability (an unwritten warranty that the Product is fit for ordinary use) are limited to one year from the date of purchase. Some states/provinces do not allow limitations on how long an implied warranty lasts, so the above limitation may not apply to you. In no event shall VTech be liable for any indirect, special, incidental, consequential, or similar damages (including, but not limited to lost profits or revenue, inability to use the Product or other associated equipment, the cost of substitute equipment, and claims by third parties) resulting from the use of this Product. Some states/provinces do not allow the exclusion or limitation of incidental or consequential damages, so the above limitation or exclusion may not apply to you.

Please retain your original sales receipt as proof of purchase.

Appendix

Technical specifications

Frequency control	Crystal controlled PLL synthesizer
Transmit frequency	Handset: 1921.536-1928.448 MHz Telephone base: 1921.536-1928.448 MHz
Channels	5
Nominal effective range	Maximum power allowed by FCC and IC. Actual operating range may vary according to environmental conditions at the time of use.
Power requirements	Handset: 2.4V Ni-MH battery Telephone base: 6V DC @ 400mA
Memory	Directory: 50 memory locations; up to 30 digits and 15 characters Caller ID log: 50 memory locations; up to 24 digits and 15 characters

Index

A

Add a directory entry 30–31
Add a handset 54
Alphabetical search 32
Announcement 43
Answer a call 20
Answer on/off 44
Auto answer 18

B

Base layout 5–7
Battery 3, 4, 59

C

Call screening 45, 49
Call transfer 25
Call waiting 21
Caller ID log 38
Caller ID log messages 42
Chain dialing 22
Charging 4
Clock 13

D

Date and time 13
Delete a caller ID log entry 42
Delete a directory entry 34
Deregister handsets 55
Dial a caller ID log entry 41
Dial a directory entry 33
Dialing options 40
Dial mode 17
Directory 29–36
DSL filter 2

E

ECO mode 69
Edit a directory entry 33
End a call 20

F

FCC, ACTA and IC regulations 72–73
Find handset 23
Flash 21

H

Handset battery charging 4
Handset battery installation 3
Handset icons 58
Handset layout 8–9
Handset locator 23
Home area code 17

I

Icons 58
Important safety instructions 68
Installation 2
Installation (battery) 3
Installation (telephone base) 2
Intercom 27, 28

J

Join a call 26

K

Key tone 16

L

Language 14
Lights 58
Limited warranty 74–75

M

Maintenance 70
Make a call 19
Memo 52
Menu 10
Message playback 51
Missed call indicator 39
Mute 21

N

Number of rings 45

O

Operating range 69
Options during message playback 51

P

Parts checklist 1
Precautions for users of implanted cardiac pacemakers 69
Predial 19

Q

Quiet mode 12

R

Redial 24
Register a handset 54
Remote access 53
Remote access code 46
Review the caller ID log 39
Ringer tone 11
Ringer volume 11

Index

S

- Safety instructions 68
- Save a caller ID log entry 41
- Screen messages 42, 56
- Share a call 26
- Speakerphone 19, 20

T

- Technical specifications 76
- Telephone base layout 5–7
- Telephone base lights 58
- Temporary ringer silencing 21
- Temporary tone dialing 22
- Transfer a call 25
- Troubleshooting 60–67

U

- Using the menu 10

V

- Voicemail 15, 16, 23, 48
- Voicemail indicators 16
- Volume 11, 20, 51

W

- Warranty 74–75
- Website 23

VTECH TELECOMMUNICATIONS LTD.
A member of THE VTECH GROUP OF COMPANIES.
VTech is the registered trademark of VTech Holdings Limited.
Copyright © 2012 for VTECH TELECOMMUNICATIONS LTD.
All rights reserved. Version 1 09/12.

91-006037-010-100

vtech[®]