

Go to www.vtechphones.com (US) to register your product for enhanced warranty support and the latest VTech product news.

Go to phones.vtechcanada.com (Canada) for the latest VTech product news.

IS8151-1S	IS8151
IS8151-2S	IS8151-2
IS8151-3S	IS8151-3
IS8151-4S	IS8151-4
IS8151-5S	IS8151-43
IS8152-5S	IS8151-47
	IS8151-5
	IS8152-5

DECT 6.0 Cordless telephone with BLUETOOTH® wireless technology

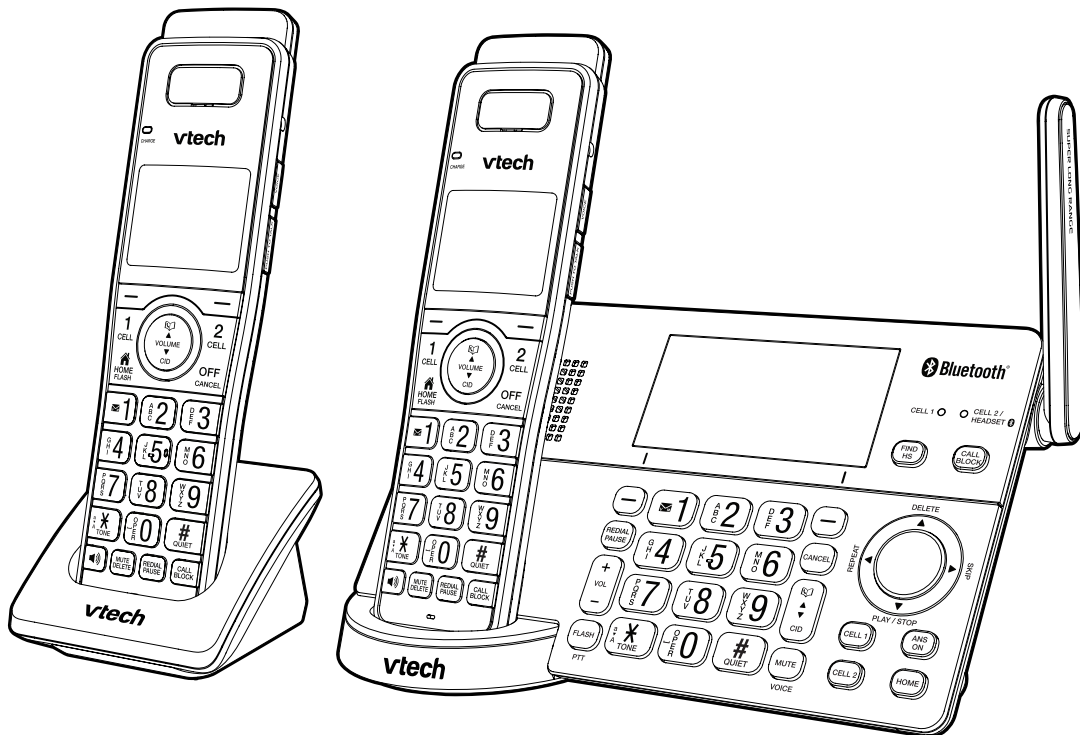

vtech[®]
User's manual

Congratulations

on purchasing your new VTech product. Before using this telephone, please read **Important safety instructions**.

This manual has all the feature operations and troubleshooting necessary to install and operate your new VTech telephone. Please review this manual thoroughly to ensure proper installation and operation of this innovative and feature rich VTech product.

For support, shopping, and everything new at VTech, visit our website at

www.vtechphones.com. In Canada, please visit **phones.vtechcanada.com**.

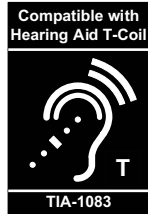

Telephones identified with this logo have reduced noise and interference when used with most T-coil equipped hearing aids and cochlear implants. The TIA-1083 Compliant Logo is a trademark of the Telecommunications Industry Association. Used under license.



The ENERGY STAR® program (www.energystar.gov) recognizes and encourages the use of products that save energy and help protect our environment. We are proud to mark this product with the ENERGY STAR label indicating it meets the latest energy efficiency guidelines.

Important safety instructions

When using your telephone equipment, basic safety precautions should always be followed to reduce the risk of fire, electric shock and injury, including the following:

1. Read and understand all instructions.
2. Follow all warnings and instructions marked on the product.
3. Unplug this product from the wall outlet before cleaning. Do not use liquid or aerosol cleaners. Use a damp cloth for cleaning.
4. **CAUTION:** Do not install the telephone base at a height above 2 meters.
5. Do not use this product near water such as near a bath tub, wash bowl, kitchen sink, laundry tub or a swimming pool, or in a wet basement or shower.
6. Do not place this product on an unstable table, shelf, stand or other unstable surfaces.
7. Avoid placing the telephone system in places with extreme temperature, direct sunlight, or other electrical devices. Protect your phone from moisture, dust, corrosive liquids and fumes.
8. Slots and openings in the back or bottom of the telephone base and handset are provided for ventilation. To protect them from overheating, these openings must not be blocked by placing the product on a soft surface such as a bed, sofa or rug. This product should never be placed near or over a radiator or heat register. This product should not be placed in any area where proper ventilation is not provided.
9. This product should be operated only from the type of power source indicated on the marking label. If you are not sure of the type of power supply in your home or office, consult your dealer or local power company.
10. Do not allow anything to rest on the power cord. Do not install this product where the cord may be walked on.
11. Never push objects of any kind into this product through the slots in the telephone base or handset because they may touch dangerous voltage points or create a short circuit. Never spill liquid of any kind on the product.
12. To reduce the risk of electric shock, do not disassemble this product, but take it to an authorized service facility. Opening or removing parts of the telephone base or handset other than specified access doors may expose you to dangerous voltages or other risks. Incorrect reassembling can cause electric shock when the product is subsequently used.
13. Do not overload wall outlets and extension cords.
14. Unplug this product from the wall outlet and refer servicing to an authorized service facility under the following conditions:
 - When the power supply cord or plug is damaged or frayed.
 - If liquid has been spilled onto the product.
 - If the product has been exposed to rain or water.
 - If the product does not operate normally by following the operating instructions. Adjust only

those controls that are covered by the operation instructions. Improper adjustment of other controls may result in damage and often requires extensive work by an authorized technician to restore the product to normal operation.

- If the product has been dropped and the telephone base and/or handset has been damaged.
 - If the product exhibits a distinct change in performance.
15. Avoid using a telephone (other than cordless) during an electrical storm. There is a remote risk of electric shock from lightning.
 16. Do not use the telephone to report a gas leak in the vicinity of the leak. Under certain circumstances, a spark may be created when the adapter is plugged into the power outlet, or when the handset is replaced in its cradle. This is a common event associated with the closing of any electrical circuit. The user should not plug the phone into a power outlet, and should not put a charged handset into the cradle, if the phone is located in an environment containing concentrations of flammable or flame-supporting gases, unless there is adequate ventilation. A spark in such an environment could create a fire or explosion. Such environments might include: medical use of oxygen without adequate ventilation; industrial gases (cleaning solvents; gasoline vapors; etc.); a leak of natural gas; etc.
 17. Only put the handset of your telephone next to your ear when it is in normal talk mode.
 18. The power adapter is intended to be correctly oriented in a vertical or floor mount position. The prongs are not designed to hold the plug in place if it is plugged into a ceiling, under-the-table or cabinet outlet.
 19. For pluggable equipment, the socket outlet shall be installed near the equipment and shall be easily accessible.
 20. **CAUTION:** Use only the batteries indicated in this manual. There may be a risk of explosion if a wrong type of battery is used for the handset. Use only the supplied rechargeable batteries or replacement batteries (BT183342/ BT283342) for the handset. Do not dispose of batteries in a fire. They may explode.
 21. Use only the adapter included with this product. Incorrect adapter polarity or voltage can seriously damage the product.

SAVE THESE INSTRUCTIONS

Battery

- **CAUTION:** Use Only Supplied Battery.
- Do not dispose of the battery in a fire. Check with local waste management codes for special disposal instructions.
- Do not open or mutilate the battery. Released electrolyte is corrosive and may cause burns or injury to the eyes or skin. The electrolyte may be toxic if swallowed.
- Exercise care in handling batteries in order not to create a short circuit with conductive materials.
- Charge the battery provided with this product only in accordance with the instructions and limitations specified in this manual.

Precautions for users of implanted cardiac pacemakers

Cardiac pacemakers (applies only to digital cordless telephones):

Wireless Technology Research, LLC (WTR), an independent research entity, led a multidisciplinary evaluation of the interference between portable wireless telephones and implanted cardiac pacemakers. Supported by the U.S. Food and Drug Administration, WTR recommends to physicians that:

Pacemaker patients

- Should keep wireless telephones at least six inches from the pacemaker.
- Should NOT place wireless telephones directly over the pacemaker, such as in a breast pocket, when it is turned ON.
- Should use the wireless telephone at the ear opposite the pacemaker.

WTR's evaluation did not identify any risk to bystanders with pacemakers from other persons using wireless telephones.

About cordless telephones

- **Privacy:** The same features that make a cordless telephone convenient create some limitations. Telephone calls are transmitted between the telephone base and the cordless handset by radio waves, so there is a possibility that the cordless telephone conversations could be intercepted by radio receiving equipment within range of the cordless handset. For this reason, you should not think of cordless telephone conversations as being as private as those on corded telephones.
- **Electrical power:** The telephone base of this cordless telephone must be connected to a working electrical outlet. The electrical outlet should not be controlled by a wall switch. Calls cannot be made from the cordless handset if the telephone base is unplugged, switched off or if the electrical power is interrupted.
- **Potential TV interference:** Some cordless telephones operate at frequencies that may cause interference to televisions and VCRs. To minimize or prevent such interference, do not place the telephone base of the cordless telephone near or on top of a TV or VCR. If interference is experienced, moving the cordless telephone farther away from the TV or VCR often reduces or eliminates the interference.
- **Rechargeable batteries:** Exercise care in handling batteries in order not to create a short circuit with conducting material such as rings, bracelets and keys. The battery or conductor may overheat and cause harm. Observe proper polarity between the battery and the battery charger.
- **Nickel-metal hydride rechargeable batteries:** Dispose of these batteries in a safe manner. Do not burn or puncture the battery. Like other batteries of this type, if burned or punctured, they could release caustic material which could cause injury.

Table of contents

Important safety instructions	11
What's in the box	1
Overview	2
Telephone base overview	2
Handset overview.....	3
Charger overview	4
Display icons overview.....	4
Telephone base lights overview	4
Connect	5
Connect the telephone base	5
Connect the charger.....	5
Mount the telephone base	5
Install and charge the battery	6
Install belt clip.....	7
Improve the telephone signal strength	7
Before use	7
Set date and time	7
Voice guide for Smart call blocker* / Answering system	7
Check for dial tone.....	7
Introducing Bluetooth	8
Operating range	8
Battery backup mode.....	8
Glossary of terms.....	9
VTech Connect to Cell™ application.....	9
Bluetooth setup	9
Add a cell phone.....	9
Add a headset	10
Auto connection.....	10
Bluetooth connection from idle mode	10
Review the device list.....	10
Connect/disconnect an active device	10
Remove a paired device.....	11
Replace an active device.....	11
Download phonebook	11
Interruption to phonebook directory download	12
View the directory download information	12
Remote voice control	12
Activate remote voice control.....	12
Configure your telephone	13
Use the handset and telephone base menu	13
Set language	13
Set date and time	13
Set voice language	13
Caller ID announce	14
Use caller ID to automatically set date and time	14
Set speed dial voicemail number.....	14
Voicemail (visual message waiting) indicator	14
Clear voicemail indication.....	14
Home area code	15
Cell area code.....	15
Dial mode.....	15
Temporary tone dialing	15
No line alert.....	15
Cell alert.....	15

Telephone operations	16
Make, answer or end a home call	16
Call waiting on the home line	17
Make, answer or end a cell call.....	17
Call waiting on the cell line.....	17
Answer an incoming cell call while on a home call.....	18
Answer a home call while on a cell call	18
Conference home and cell calls	18
Handset speakerphone	19
Volume.....	19
Silence the ringer	19
Mute	19
Hold	20
Equalizer	20
Join a call in progress (for multiple handset models only)	20
Chain dialing	21
Find handset	22
Redial list	22
Review a redial list entry	22
Dial a redial list entry.....	22
Save a redial entry to the phonebook.....	23
Delete a redial list entry	24
Sound settings	24
Key tone.....	24
Ringer tone	24
Ringer volume	24
QUIET mode	25
Temporary ringer silencing	25
Intercom	25
Answer an incoming call during an intercom call.....	26
Call transfer using intercom	27
Push-to-talk (PTT)	28
Turn PTT on or off.....	28
PTT call to a single device.....	28
PTT call to multiple devices	29
Answer a PTT call	30
Change a one-to-one PTT call to an intercom call	30
Answer an incoming call during a PTT call.....	30
Make an outgoing call during a PTT call	30
End or leave a PTT call.....	30
Phonebook	31
Add a phonebook directory entry.....	31
Add a predialed telephone number to the phonebook	32
Review a phonebook entry.....	32
3-character alphabetical search	33
Dial a phonebook entry.....	33
Edit a phonebook entry.....	33
Edit the type of a phonebook entry	34
Delete a phonebook entry.....	34
Remove a downloaded cell phone directory.....	34
Caller ID	34
Review a caller ID log entry.....	34
Memory match	34
Missed call indicator	35
View dialing options.....	35
Dial a caller ID log entry.....	35
Save a caller ID log entry to the phonebook	35

Save a caller ID log entry to the allow list.....	36
Save a caller ID log entry to the block list	37
Save a caller ID log entry to the star name list.....	37
Delete the caller ID log entries.....	37
About Smart call blocker	38
Call categories	38
Call handling.....	39
Set Smart call blocker on/off.....	40
Set profile.....	40
Block list.....	41
Allow list.....	42
Star name list.....	44
Screening announcements.....	45
Voice guide to set Smart call blocker	46
Allowed calls.....	47
Blocked calls.....	47
Screen unknown home calls	48
Screen robocalls.....	49
Option while on a call	49
About the built-in answering system and voicemail service	50
Set your built-in answering system	50
Turn the answering system on or off	50
Default announcement	51
Record your own announcement	51
Play the announcement	51
Delete the announcement	51
Voice guide to set Answering system	52
Set number of rings.....	53
Set recording time	53
Turn the call screening on or off.....	54
Turn the message alert tone on or off	54
Answering system and voicemail indicators	55
Use the answering machine and voicemail together.....	55
Message capacity.....	55
Voice prompts	55
Call screening	55
Call intercept.....	56
Temporarily turn off the message alert tone.....	56
Message playback	56
Delete all old messages	57
Record and play memos.....	58
Remote access	58
Set remote access code	59
Record, play or delete memos	59
Register a handset	60
Screen messages.....	60
General product care.....	62
Frequently asked questions.....	63
The RBRC seal.....	65
FCC, ACTA and IC regulations	66
California Energy Commission battery charging testing instructions	67
For C-UL compliance only	68
Limited warranty.....	70
Disclaimer and Limitation of Liability	71
Technical specifications	71

What's in the box

Your telephone package contains the following items. Save your sales receipt and original packaging in the event warranty service is necessary.

NOTE

- To purchase a replacement battery or power adapter, visit our website at www.vtechphones.com or call **1 (800) 595-9511**. In Canada, go to phones.vtechcanada.com or call **1 (800) 267-7377**.

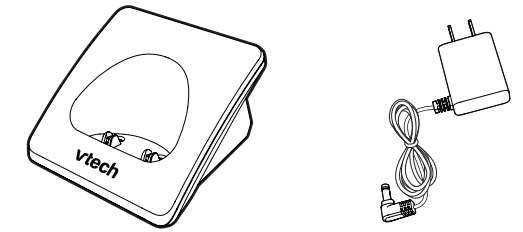

- 1 sets for IS8151-2/IS8151-2S
- 2 sets for IS8151-3/IS8151-3S
- 3 sets for IS8151-4/IS8151-43/IS8151-47/IS8151-4S
- 4 sets for IS8151-5/IS8151-5S/IS8152-5/IS8152-5S

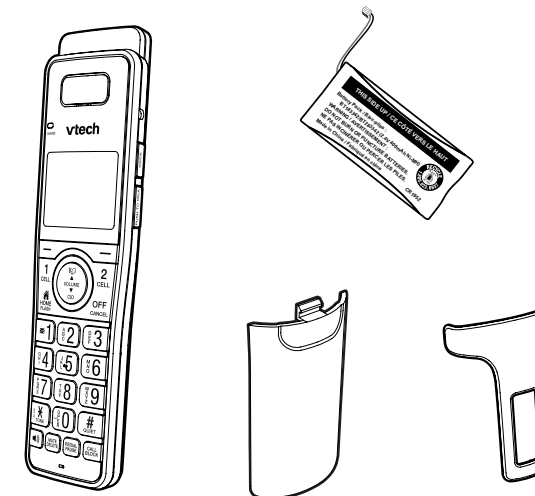
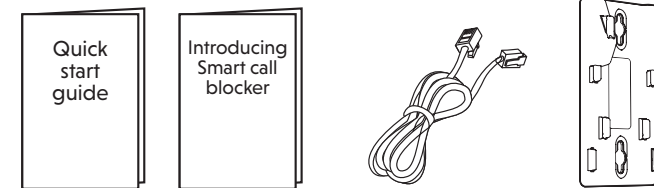

- 1 set for IS8151/IS8151-1S
- 2 sets for IS8151-2/IS8151-2S
- 3 sets for IS8151-3/IS8151-3S
- 4 sets for IS8151-4/IS8151-43/IS8151-47/IS8151-4S
- 5 sets for IS8151-5/IS8151-5S/IS8152-5/IS8152-5S

Overview

Telephone base overview

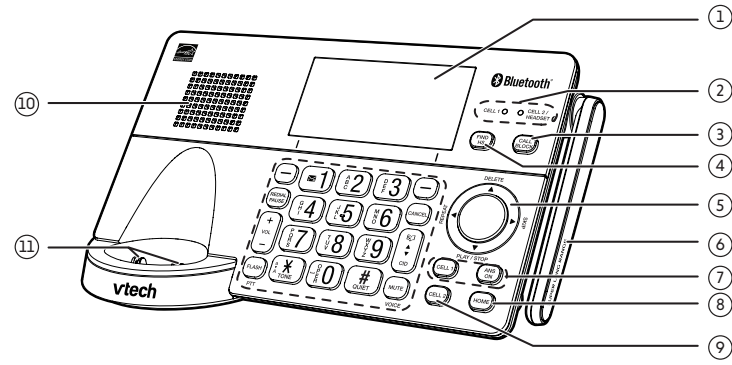

1 – LCD display

2 – CELL 1 Light

- On when the telephone is paired and connected with a Bluetooth device.

- Flashes alternately while pairing a Bluetooth device.

CELL 2/Headset Light

- On when the telephone is paired and connected with a Bluetooth device or headset.

- Flashes alternately while pairing a Bluetooth device or headset.

3 – CALL BLOCK

- Press to block the incoming call when the telephone is ringing.
- When on a call, press to block the call.
- When the telephone base is not in use, press to show the call block menu.

4 – FIND HS

- Press the button to page all system handsets.

5 – SKIP

- Skip to the next message.

PLAY/STOP

- Play messages.
- Stop playing messages.

REPEAT

- During message playback, press to repeat the message.

DELETE

- During message playback, press to delete the message.

6 – Antenna

7 – ANS ON

- Turn on or off the answering system.

8 – HOME

- Press to make or answer a home call.
- Flashes quickly when there is an incoming home call.

9 – CELL 1 / CELL 2

- Press to make or answer a cell call.

10 – Speaker

11 – Charging pole

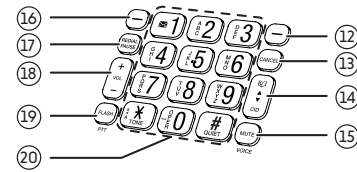

12 – Softkey

- Press to select the menu item displayed above the key.
- While in a menu, press to select an item, save an entry or setting, cancel an operation, or back up to the previous menu.

13 – CANCEL

- While in a menu, press to exit without making changes or press and hold to return to idle mode.
- Press and hold while the telephone is not in use to erase the missed call indicator.

14 – ▲

- Press to scroll up while in a menu.
- Press to show phonebook entries when the telephone is not in use.
- While entering names or numbers, press to move the cursor to the right.

CID ▼

- Press to scroll down while in a menu.
- Press to review the caller ID log when the telephone is not in use.
- While entering names or numbers, press to move the cursor to the left.

15 – MUTE / VOICE

- During a call, press to mute the microphone.
- While the telephone base is ringing, press to silence the ringer temporarily.
- Press to activate the voice-controlled application of connected cell phone.

16 – Softkey

- Press to select the menu item displayed above the key.
- While in a menu, press to select an item, save an entry or setting, cancel an operation, or back up to the previous menu.

17 – REDIAL / PAUSE

- Press repeatedly to view the numbers dialed.
- While entering numbers, press and hold to insert a dialing pause.

18 – VOL + / -

- Press to adjust the volume during message playback.
- Press to adjust the listening volume during a call.
- When the phone is not in use, press to adjust the telephone base ringer volume for all lines.

19 – FLASH / PTT

- Press to display the PTT menu to begin a PTT call.
- Press and hold to begin a one-to-group broadcast when the telephone base is not in use.
- During a call, press to answer an incoming home call when you receive a call waiting alert.

20 – 1

- While reviewing a caller ID log entry, press repeatedly to add or remove 1 in front of the telephone number before dialing or saving it in the phonebook.
 - Press and hold to set or to dial your voicemail number.
- #### TONE ✕
- Press to switch to tone dialing temporarily during a call if you have pulse service.
- While entering names, press to change the next letter to upper or lower case.
- #### QUIET #
- Press and hold to enter the QUIET mode setting screen, or to deactivate QUIET mode.

Handset overview

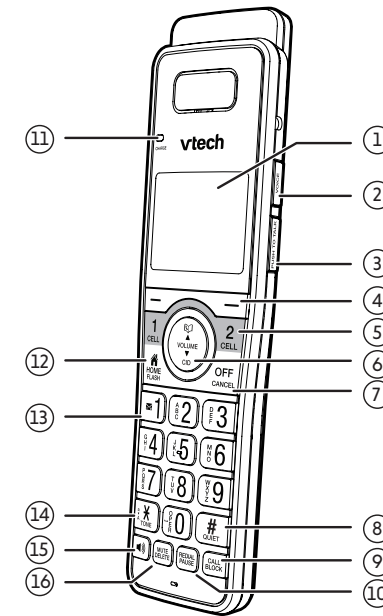

1 – LCD display

2 – VOICE

- Press to activate the voice-controlled application of connected cell phone.

3 – PUSH TO TALK

- Press to initiate a one-to-one or one-to-group broadcast.
- Press and hold to broadcast to a group of system devices.

4 – Softkeys (2)

- Press to select the menu item displayed above the key
- While in a menu, press to select an item, save an entry or setting, cancel an operation, or back up to the previous menu.

5 – CELL 1 / CELL 2

- Press to make or answer a cell call.
- During a cell call, press to answer an incoming CELL 1/2 call when you hear a call waiting alert.
- During message playback, press to call back the caller if the caller's number is available.

6 – ▲ / ▲ VOLUME

- Press to show phonebook entries when the handset is not in use.

- Press to scroll up while in menus.
- While entering names or numbers, press to move the cursor to the right.

CID / ▼ VOLUME

- Press to show caller ID log when the handset is not in use.
- Press to scroll down while in menus.
- Press to decrease the listening volume when on a call or to decrease the message playback volume.
- While entering names or numbers, press to move the cursor to the left.

7 – OFF / CANCEL

- During a call, press to hang up.
- While in a menu, press to cancel an operation, back up to the previous menu, or exit the menu display; or press and hold this button to exit to idle mode.
- When the handset is ringing, press to mute the ringer temporarily.
- Press and hold while the telephone is not in use to erase the missed call indicator.

8 – QUIET

- Press to display other dialing options when reviewing a caller ID log entry.
- Press and hold to enter the QUIET mode setting screen, or to deactivate QUIET mode.

9 – CALL BLOCK

- Press to block the incoming call when the telephone is ringing.
- When on a call, press to block the call.
- When the handset is not in use, press to show the call block menu.

10 – REDIAL / PAUSE

- Press to review the redial list.
- Press and hold to insert a dialing pause while entering a number.

11 – CHARGE light

- On when the handset is charging in the telephone base or charger.

12 – HOME / FLASH

- Press to make or answer a home call.
- During message playback, press to call back the caller if the caller's number is available.
- During a call, press to answer an incoming home call when you receive a call waiting alert.

13 – 1

- While reviewing a caller ID log entry, press to add or remove 1 in front of the telephone number before dialing or saving it in the phonebook.
- Press and hold to set or to dial your voicemail number.

14 – TONE ✕

- Press to switch to tone dialing temporarily during a call if you have pulse service.
- While entering names, press to change the next letter to upper or lower case.

15 – SPEAKERPHONE

- Press to make or answer a home or cell call using the speakerphone.
- Press to switch between the speakerphone and the handset.

16 – MUTE / DELETE

- During a call, press to mute the microphone.
- When the handset is ringing, press to mute the ringer temporarily.
- While reviewing the caller ID log, the phonebook or the redial memory, press to delete an individual entry.
- During message or announcement playback, press to delete the playing message or the recorded announcement.

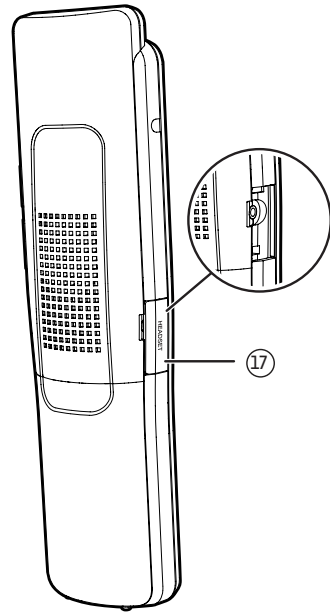

17 – Headset jack

Charger overview

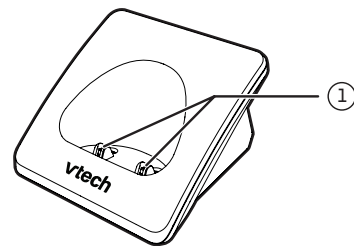

1 – Charging pole

Display icons overview

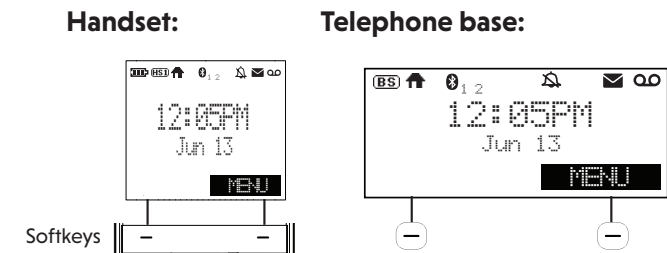

MENU	Option displayed above a softkey. Press or to select.
	The handset battery low and needs charging.
	The handset battery is charging.
HS1	Handset indicates the handset number.
	Handset or telephone base ringer is off.
	New voicemail received from your telephone service provider.
	The HOME line is in use.
	Bluetooth device is active.
	Bluetooth device is in use.
	Wireless Bluetooth headset is in use.
OO	Answering system is on.
NEW	There are new caller ID log entries and/or new messages.

Telephone base lights overview

CELL 1 / CELL 2/Headset	<ul style="list-style-type: none"> • On when the telephone is paired and connected with a Bluetooth device or headset. • Flashes alternately while pairing a Bluetooth device or headset.
--------------------------------	---

Connect

You can choose to connect the telephone base for desktop usage or wall mounting.

NOTES

- Use only the adapters provided.
- Make sure the electrical outlets are not controlled by wall switches.
- The adapters are intended to be correctly oriented in a vertical or floor mount position. The prongs are not designed to hold the plug in place if it is plugged into a ceiling, under-the-table or cabinet outlet.

TIP

- If you subscribe to digital subscriber line (DSL) high-speed Internet service through your telephone line, make sure you install a **DSL filter** (not included) between the telephone line cord and telephone wall jack. Contact your DSL service provider for more information.

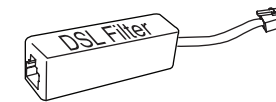

Connect the telephone base

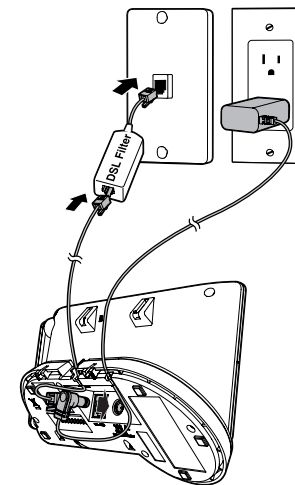

Connect the charger

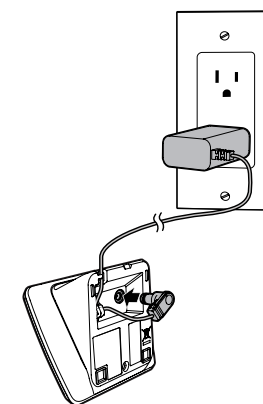

Mount the telephone base

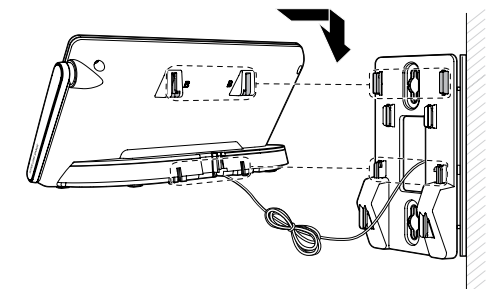
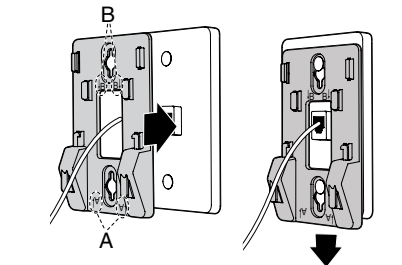
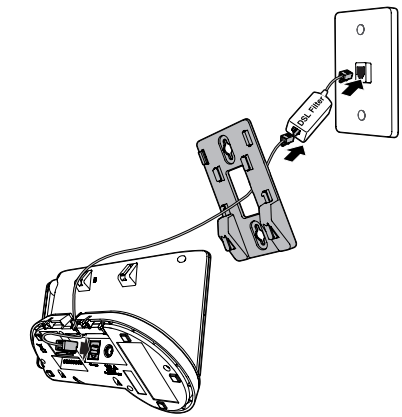

Install and charge the battery

Install the battery

Install the battery as shown below.

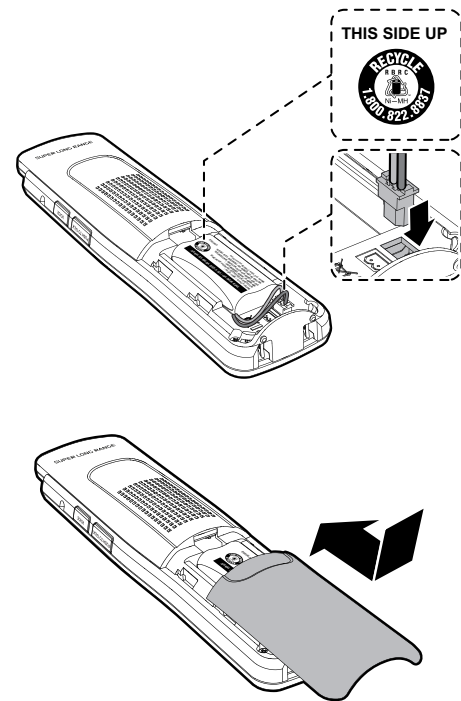

NOTES

- Use only supplied battery.
- Charge the battery provided with this product only in accordance with the instructions and limitations specified in this manual.
- If the handset will not be used for a long time, disconnect and remove the battery to prevent possible leakage.

Charge the battery

Place the handset in the telephone base or the charger to charge.

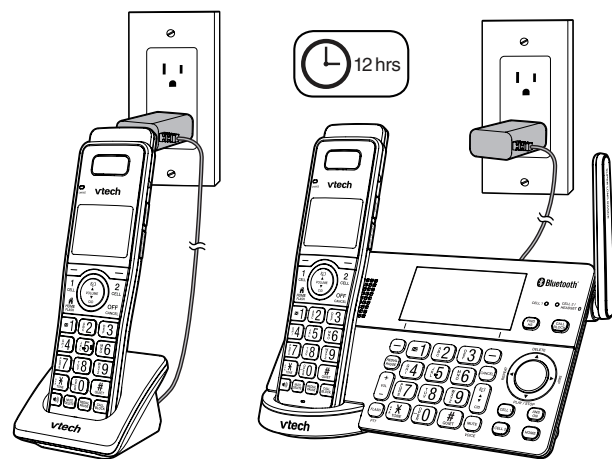

Once you have installed the battery, the handset LCD display indicates the battery status (see the following table).

NOTES

- For best performance, keep the handset in the telephone base or charger when not in use.
- The battery is fully charged after 12 hours of continuous charging.
- If you place the handset in the telephone base or the charger without plugging in the battery, the screen displays **No battery**.

Battery indicators	Battery status	Action
The screen is blank, or displays Place in charger and [] flashes.	The battery has no or very little charge. The handset cannot be used.	Charge without interruption (at least 30 minutes).
The screen displays Low battery and [] flashes.	The battery has enough charge to be used for a short time.	Charge without interruption (about 30 minutes).
The screen displays HANDSET X .	The battery is charged.	To keep the battery charged, place it in the telephone base or charger when not in use.

When the battery is fully charged, you can expect the following performance:

Operation	Operating time
While in use (talking*)	15 hours
While not in use (standby**)	10 days

* Operating times vary depending on your actual use and the age of the battery.

** Handset is not charging nor in use.

Install belt clip

To attach the belt clip

Snap the belt clip into the slots on both sides of the cordless handset.

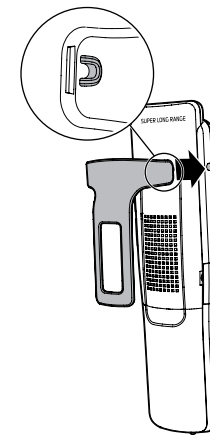

To remove the belt clip

Lift either of the belt clip tabs outwards from the handset.

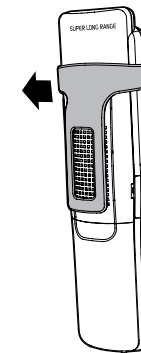

Improve the telephone signal strength

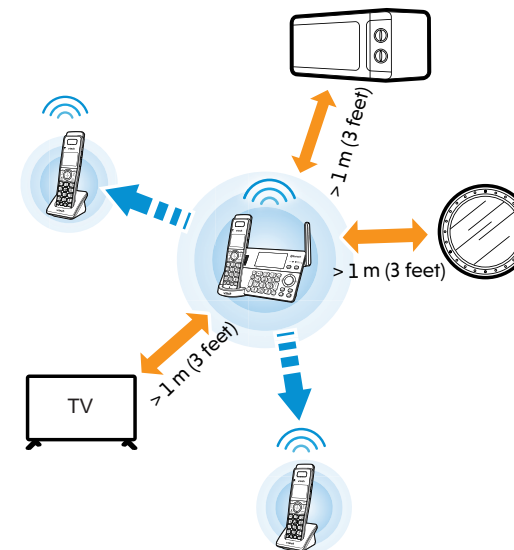

NOTE

- To avoid interference, place the telephone base in a central location of the house and at least 3 feet (1 meter) away from thick walls as well as other household appliances such as, TV, radio, microwave oven, Wi-Fi router, large mirror, metal furniture and fish tank.

Before use

After you install your telephone or power returns following a power outage and battery depletion, the handset and telephone base will prompt you to set the date and time, and to configure the Smart call blocker* and answering system through voice guide.

Set date and time

NOTE

- Make sure you set the date and time including the year correctly; otherwise the answering system does not announce the correct day of the week for your recorded messages time stamp.
1. Use the dialing keys (0-9) to enter the month (MM), date (DD) and year (YY). Then press **NEXT**.
 2. Use the dialing keys (0-9) to enter the hour (HH) and minute (MM). Then press ▼ **CID** or ▲ [] to choose **AM** or **PM**.
 3. Press **SAVE** to save.

Voice guide for Smart call blocker* / Answering system

After the date and time setting is done or skipped, the handset and the telephone base will prompt if you want to set Smart call blocker. Press **YES** to start the Smart call blocker setup via voice guide. For more details, see **Voice guide to set Smart call blocker** section. To skip the setup, press **NO**, or press **CANCEL** on the handset or telephone base, and then press **OK**.

After the Smart call blocker setting is done or skipped, the handset and the telephone base will then prompt if you want to set up the answering system. Press **YES** to start the answering system setup via voice guide. For more details, see **Voice guide to set Answering system** section. To skip the setup, press **NO**, or press **CANCEL** on the handset or telephone base, and then press **OK**.

Check for dial tone

Press **HOME**. If you hear a dial tone, the installation is successful.

If you do not hear a dial tone:

- Make sure the installation procedures described above are properly done.
- It may be a wiring problem. If you have changed your telephone service to digital service from a cable company or a VoIP service provider, the telephone line may need to be rewired to allow all existing telephone jacks to work. Contact your cable/VoIP service provider for more information.

*Includes licenced Qaltel™ technology. Qaltel™ is a trademark of Truecall Group Limited.

Operating range

This cordless telephone operates with the maximum power allowed by the Federal Communications Commission (FCC). Even so, this handset and telephone base can communicate over only a certain distance - which can vary with the locations of the telephone base and handset, the weather, and the layout of your home or office.

When the handset is out of range, the handset displays **Out of range or no pwr at base**.

If there is a call while the handset is out of range, it may not ring, or if it does ring, the call may not connect well when you press **HOME**. Move closer to the telephone base, then press **HOME** to answer the call.

If the handset moves out of range during a telephone conversation, there may be interference. To improve reception, move closer to the telephone base.

Battery backup mode

Battery backup mode allows your telephone system to function in the event of a power outage. The telephone system uses stored power from the handset's battery to operate.

To activate the mode

After the power goes out, if there is already a handset with enough charge placed in the telephone base, the telephone system enters battery backup mode automatically. That handset screen shows **Powering base... Don't pick up**. All other handset screens show **Battery backup mode**.

-OR-

ORif

there is no handset placed in the telephone base after the power goes out, all handsets show **Out of range OR no power at base** and **Put HS on base to power base**, alternately. Place any handset with enough charge in the telephone base. Its screen shows **Powering base... Don't pick up**. All other handset screens show **Battery backup mode**.

Operation

During battery backup mode, the telephone base, answering system and all Bluetooth related features will be disabled. The operating time is subject to the battery level of the handset placed in the telephone base and the actual usage. For optimal performance, we recommend that you do not use the handset placed in the telephone base when this mode is on.

Using other system handsets (Recommended):

Operate the handsets the same way as usual, except the answering system and all Bluetooth related features which will be disabled.

Using the handset placed in the telephone base:

To maximize the operating time, you are not advised to use this handset. If you do have to use it, make sure you do not lift it from the telephone base. All operations should be done with the handset placed in the telephone base. In this case, calls can only be made and received using the speakerphone.

Introducing Bluetooth

Your new telephone system with Bluetooth wireless technology has the following features:

- Pair up to 2 Bluetooth enabled devices (cell phones or headsets) with the telephone base.
- Connect a maximum of 2 Bluetooth enabled devices to make and receive cell calls. Both devices can be active on a call at a time.
- Connect a Bluetooth enabled headset for making and receiving home calls.
- Conference any combination of cell and home call.
- Make and receive calls using your cell phone service with your telephone base or system handsets.
- Download phonebook entries from your cell phone.

IMPORTANT INFORMATION

- Your telephone is compatible with Bluetooth version 2.0 or above devices.
- After plugging in the telephone base, wait at least 20 seconds before connecting a Bluetooth device. The screen shows Bluetooth system busy if you try to connect too soon.
- Refer to the user's manual of your Bluetooth enabled cell phone or headset for more information about how that device uses Bluetooth connectivity.
- Bluetooth wireless technology operates within a short range (a maximum of approximately 15 feet) from the telephone base. Keep connected cell phones and headsets within this range.
- If your cell phone has poor reception in your home, the telephone cannot improve the reception. However, if there is a location in your house with better reception, you can leave your cell phone at that location while you use the telephone cell line. For optimal performance, the cell phone must be within 15 feet of the telephone base.
- If you experience poor sound quality, it may be caused by the distance between your cell phone and the telephone base. To improve the performance, place your cell phone closer to the telephone base (within 15 feet) and make sure that there are no physical obstacles such as large furniture or thick wall in between.

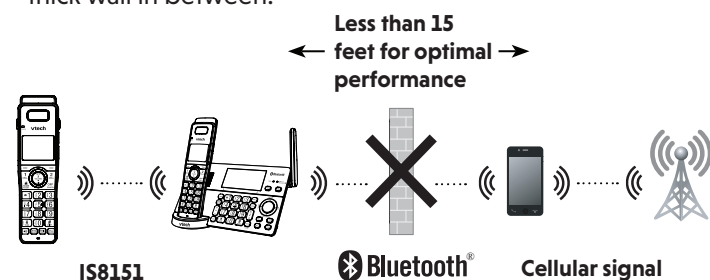

- Charge your cell phone while it is connected to the telephone base. Your cell phone's battery discharges faster while it is connected to the telephone base via Bluetooth wireless technology.
- Monitor your cell phone's usage because minutes may be deducted from your cellular plan for the duration of all cell calls, depending on the terms of your plan.

The Bluetooth® word mark and logos are owned by Bluetooth SIG, Inc. and any use of such marks by VTech Holdings Limited is under license. VTech Holdings Limited is a member of Bluetooth SIG, Inc. Other trademarks and trade names are those of their respective owners.

Refer to the Bluetooth setup section to learn how to set up your Bluetooth device. Refer to the Telephone operation section on how to operate your Bluetooth devices with your new telephone system with Bluetooth wireless technology.



Glossary of terms

Below are some terms used in this user's manual to help you become familiar with using your Bluetooth devices and your new VTech telephone system.



Active devices - the **Device list** has two active slots for two cell phones, or one cell phone and one headset. When a device in the list is active, it will have a **D1:** or **D2:** in front of the device name. In order to use a Bluetooth device on a call, it must be in an active slot and be connected.

Bluetooth cell phone - refers to a mobile Bluetooth enabled cellular telephone.

CELL line - the telephone line associated with your cell phone service. On your telephone base and handset, press **CELL 1** or **CELL 2** to use the cell line.

Connected - when you pair a Bluetooth device to your telephone system, it is placed in an active slot and automatically connected. When a device is connected, a **1** and/or **2** will display after  on the handset and telephone base screen. Also, the **CELL 1** and/or **CELL 2/HEADSET**  light on the telephone base will be on. If a device loses its connection to the telephone base, it must be reconnected before you can use the device with the telephone system.

Device list - The list of devices that have been paired to the telephone. You can pair up to 2 Bluetooth enabled devices (cell phones or headsets).

Disconnected - when a device is disconnected, **1** and/or **2** displays after  on the handset and telephone base screen. The **CELL 1** and/or **CELL 2/HEADSET**  light on the telephone base is/are off.

Discoverable mode - before a Bluetooth enabled device can be paired, it must be set to this mode. When pairing your cell phone, the telephone base will be set to this mode. Depending on the manufacturer, this mode is sometimes referred to as **Find Me** or **Visibility**.

Paired devices - The Bluetooth enabled devices (cell phones or headsets) that have shared registration information with the telephone base. A total of four Bluetooth enabled devices can be paired to the telephone base. However, only two paired devices can communicate with the base at a time.

Pairing - sometimes referred to as bonding. The process of sharing registration information between two Bluetooth enabled devices. Your Bluetooth enabled cell phone or headset must first be paired to the telephone base in order to use it with this telephone system.

VTech Connect to Cell™ application

If you are using Bluetooth-enabled Android® phones (OS 2.3 or higher), you can further extend the flexibility of your telephone system with use of the free **Connect To Cell** application.

VTech **Connect to Cell** comprises **Caller ID manager** and **Alerts manager** that help you integrate your cell phone with your new telephone system.

To learn more or download this application via Google Play® Store, go to http://www.vtechphones.com/app_connect_to_cell.



Bluetooth setup

To use a Bluetooth enabled cell phone with your **IS8151/IS8251**, you must first pair and connect it with the telephone base. The **IS8151/IS8251** telephone base and all system handsets can be used to make or answer calls on the cell phone line.



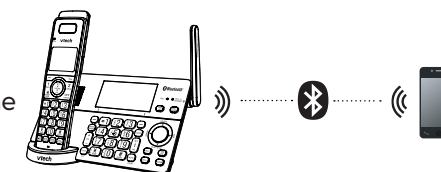

Bluetooth wireless technology operates within a short range (up to 15 feet). When you pair a Bluetooth cell phone or Bluetooth headset to the telephone base, keep the device within 15 feet of the telephone base for optimal performance.



Add a cell phone

Before you begin, make sure that you have cellular coverage and your Bluetooth enabled cell phone is not connected to any other Bluetooth device. Refer to your cell phone user's manual to learn how to search for or add new Bluetooth devices.

To pair and connect a cell phone:

1. Press **MENU** on the telephone base in idle mode to enter the main menu.
2. Press **▼ CID** or **▲**  to highlight **Bluetooth**, then press **SELECT**.
3. Press **SELECT** to choose **Add device**.
4. Press **SELECT** to choose **Add cellular**. The screen displays **Please wait...** followed by **1. If cell is connected to BT device, please disconnect it**.
5. Press **NEXT**. The screen displays **2. Place cell phone next to base**.
 - All devices that are connected to the telephone base are disconnected until the pairing process completes.
6. Press **NEXT** to turn on the telephone base discoverable mode. Promptly turn on the Bluetooth feature of your cell phone and search for or add new devices.
7. Once your cell phone finds your AT&T phone (**VTech DECT 6.0**), press the appropriate key on your cell phone to continue the pairing process.
8. When a device is successfully connected, the telephone base displays **Cell Phone Y is added and connected to base** and the corresponding status icon ( **1** or  **2**) displays (**Cell Phone Y** represents the device name of your cell phone). The corresponding device light on the telephone base (**CELL 1** or **CELL 2/HEADSET** ) turns on.

NOTES

- If there are already 2 paired devices on the list, the second one on the list will be automatically removed, regardless of whether the pairing of the new device is successful or not.
- The pairing process may take up to one minute. If the pairing process fails, try again.
- The steps for the pairing process may vary for different cell phones. If this happens, follow the prompts on your cell phone and your telephone to complete the pairing process.
- Refer to the user's manual of your cell phone on how to search for or add a new Bluetooth device.

Add a headset

Before you begin, make sure that your Bluetooth enabled headset is not connected to any other Bluetooth device. Refer to your headset user's manual to learn how to search for or add new Bluetooth devices.

To pair and connect a headset:

1. Press **MENU** on the telephone base in idle mode to enter the main menu.
2. Press **▼ CID** or **▲** to highlight **Bluetooth**, then press **SELECT**.
3. Press **SELECT** to choose **Add device**.
4. Press **▼ CID** or **▲** to highlight **Add headset**, then press **SELECT**. The screen displays **If headset is connected to cell, please disconnect it**.
5. Press **NEXT**. The screen displays **Pls set headset to discoverable mode**. Set your headset to discoverable mode (refer to the user's manual of your headset), then press **NEXT**. The screen displays **Searching for Bluetooth headsets...**
6. When the screen displays the found devices, press **▼ CID** or **▲** to highlight your headset, if necessary, then press **SELECT**.
7. The screen displays **Adding Headset Y** when the base is connecting to your headset (**Headset Y** represents the device name of your Bluetooth headset).
8. When a device is successfully connected, the telephone base displays **Headset Y is added and connected to base** and the corresponding status icon **2 (Headset Y)** represents the device name of your Bluetooth headset). You hear a confirmation tone. The corresponding light on the telephone base **CELL 2/HEADSET** turns on.

NOTES

- If there are already 2 paired devices on the device list, the second one on the list will be automatically removed, regardless of whether the pairing of the new device is successful or not.
- If there is another headset already active, the screen will show **Only the BT headset in slot 2 can be ready for connection** and then **Headset X is deactivated for adding a new device (Headset X)** represents the device name of the active Bluetooth headset).
- The pairing process may take up to one minute. If the pairing process fails, try again.
- When a connected headset is charging, it may disconnect from the telephone base and the **CELL 2/HEADSET** light on the telephone base turns off. For some headset models, you may need to turn on the headset and reconnect it to the telephone base again.

Auto connection

When an active device moves within Bluetooth range of the telephone base, or is turned on within range, the telephone base tries to connect to the device. When the device moves out of range, it is disconnected. Your device might make a connect or disconnect sound.

A connected device could also be disconnected by:

- Turning off the Bluetooth device.
- Turning off the Bluetooth feature of the device.
- Disconnecting through the telephone base **Device list**. If you disconnect through the **Device list**, the telephone base will not attempt to reconnect until your device is moved out of range and then moves back in range again.

Bluetooth connection from idle mode

When you have active devices that are not connected, **CONNECT** appears on the handset and telephone base in idle mode. Press **CONNECT** to start connecting an active device. When there are two active devices, the screen will prompt you to choose one before connection.

Review the device list

1. Press **MENU** on the telephone base in idle mode.
2. Press **▼ CID** or **▲** to highlight **Bluetooth**, then press **SELECT**.
3. Press **▼ CID** or **▲** to highlight **Device list**, then press **SELECT**.

Connect/disconnect an active device

While in the device list menu, you may connect or disconnect your active device.

1. Press **MENU** on the telephone base in idle mode.
2. Press **▼ CID** or **▲** to highlight **Bluetooth**, then press **SELECT**.
3. Press **▼ CID** or **▲** to highlight **Device list**, then press **SELECT**.
4. Press **▼ CID** or **▲** to highlight a device, then press **OPTION**.
5. Press **▼ CID** or **▲** to highlight **Connect/Disconnect** (whichever is applicable), then press **SELECT**. The telephone base displays **Device connected/Device disconnected**. You hear a confirmation tone.

NOTE

- When your active device is connected, you are prompted to select **Disconnect**. When your active device is disconnected, you are prompted to select **Connect**.

Remove a paired device

When you already have a maximum of 2 devices on the device list and you want to add another device, you must first delete one from the list.

1. Press **MENU** on the telephone base in idle mode.
 2. Press **▼ CID** or **▲** to highlight **Bluetooth**, then press **SELECT**.
 3. Press **▼ CID** or **▲** to highlight **Device list**, then press **SELECT**.
 4. Press **▼ CID** or **▲** to highlight the desired device, then press **DELETE**.
- OR-
- Press **▼ CID** or **▲** to highlight the desired device, then press **OPTION**.
 - Press **▼ CID** or **▲** to highlight **Remove**, then press **SELECT**.
5. The telephone base displays **Remove Headset X? (Headset X)** represents the device name of your Bluetooth headset). Press **YES** to confirm. The telephone base displays **Device removed from device list** and you hear a confirmation tone.

Replace an active device

If you already have 2 active devices on the device list and you want to activate a different device, you must deactivate one of the 2 active devices.

1. Press **MENU** on the telephone base in idle mode.
2. Press **▼ CID** or **▲** to highlight **Bluetooth**, then press **SELECT**.
3. Press **▼ CID** or **▲** to highlight **Device list**, then press **SELECT**.
4. Press **▼ CID** or **▲** to highlight the device you want to activate without a **D1:** or **D2:** prefix, then press **OPTION**.
5. Press **▼ CID** or **▲** to highlight **Connect**, then press **SELECT**. The screen displays **Only BT devices in slot 1 or 2 can be ready for connection** and then a list of devices for deactivation.
6. Press **▼ CID** or **▲** to highlight the device to be deactivated, then press **NEXT**. The screen displays **Cell Phone X is deactivated**. and you hear a confirmation tone. The screen then displays **Connecting Cell Phone Y to the base... (Cell Phone X and Cell Phone Y)** represent the device names of your cell phones).
7. Depending on your cell phone settings, you may need to press a key on your cell phone to confirm the connection. When the new device is successfully activated and connected, the screen displays **Device connected**. You hear a confirmation tone.

NOTE

- When adding, removing, or replacing a Bluetooth device on the active devices list, all connected devices are temporarily disconnected until the procedure completes. It may take up to 2 minutes to reconnect.

Download phonebook

You can download up to 2 or 4* cell phone directories (phonebooks), depending on your model/ serial, to your telephone system via Bluetooth wireless technology. Entire downloaded phonebook directory can store up to 4,000 entries with up to 30 digits for each phone number and 15 characters for each name.

- 2 phone directories with a maximum of 2,000 entries each; -OR-
- 4 phonebook directories with a maximum of 1,000 entries each.

Before downloading a cell phone directory, make sure the cell phone is paired, active, and connected to your telephone system.

Place your cell phone next to the telephone base when you download a cell phone directory to your telephone system.

To download a cell phone directory:

1. Press **MENU** on the telephone base in idle mode.
2. Press **▼ CID** or **▲** to highlight **Bluetooth**, then press **SELECT**.
3. Press **▼ CID** or **▲** to highlight **Download PB**, then press **SELECT**.
4. Press **▼ CID** or **▲** to highlight a device, then press **SELECT**.
5. Press **▼ CID** or **▲** to highlight one of the following options:
 - **Phone memory** - download all contacts stored in your phone memory.
 - **SIM card only** - download all contacts stored in your SIM card.
 - **Phone and SIM** - download all contacts stored in both your phone memory and SIM card.
6. Press **SELECT**. During the download, the telephone base displays the progress. All handsets display **Downloading...**
 - Your cell phone may require a passcode. In this case the screen displays **Check cellular. ENTER PASSCODE**. Enter the cell phone passcode into the telephone base and press **SET** to save.
 - Your cell phone may require you to press a key to confirm the phonebook download.
 - If the selected device's phonebook has already been downloaded to your telephone system, the telephone base displays the last update date of your cell phone. The phonebook stored on your telephone system for that cell phone will be erased and replaced with the current cell phone phonebook. If you have edited the downloaded entries, those changes will be lost. Press **NEXT** to start the download.
 - When the **Phonebook** is full, the telephone base displays **Memory is full. Replace existing directory?**. Press **YES**. Highlight the cell phone phonebook to be replaced and press **SELECT**. The screen displays **Replace Cell Phone X directory? (Cell Phone X)** represents the device name of your cell phone). Press **YES** to confirm.
7. When the downloading process completes, the telephone base displays **Download ended XXXX entries saved. (XXXX)** represents the total number of the downloaded entries). Press **OK** to return to the **Bluetooth** menu.

NOTES

- With certain cell phones, downloading from the SIM card is not supported. If this is the case, try transferring the contacts from your SIM card to your cell phone memory first, then download from your cell phone memory. For more information on how to transfer contacts from your SIM card to your cell phone memory, see your cell phone's user's manual.
- When downloading the directory from your Bluetooth enabled cell phone, some data may not transfer. For example, if you have home, mobile and work numbers for a particular contact, the three category descriptions may not transfer to your telephone system.
- For certain cell phones, you may need to press a key on your cell phone to confirm the phonebook download.
- For Android and Blackberry cell phones, you may also download your cell phone phonebook to your **IS8151/IS8251** via the VTech Contact Share application. Scan the QR code on the right, or go to www.vtechphones.com/apps/contact_share for application download.



Interruption to phonebook directory download

If you are downloading a directory from a cell phone and the phone receives a call, the download process stops and the telephone base displays **Download failed** and all the handsets display **Download fail** after the call ends. When you try to view the downloaded directory, the telephone base and handsets display **Last Download failed: MM/DD/YY**. You need to download the directory again (see **Download Phonebook**).

When you are downloading a directory from a cell phone and you wish to stop the download process, you may press **STOP**. The telephone base displays **Download directory cancelled**. The telephone base displays **Download failed** and all handsets display **Download fail** when the telephone returns to idle mode.

NOTE

- During the download process, do not attempt to make changes to your cell phone directory.

View the directory download information

- Press **MENU** on the telephone base in idle mode.
- Press **▼ CID** or **▲** until you highlight **Phonebook**, then press **SELECT**.
- Press **▼ CID** or **▲** to choose the desired downloaded directory, then press **OPTION**.
- Press **▼ CID** or **▲** to highlight **Last update**, then press **SELECT**.
 - The telephone base displays **Cell Phone X Last update MM/DD/YY Total #XXXX** (Cell Phone X represents the device name of your cell phone).
 - OR-
 - The telephone base displays **Cell Phone X Last Download failed: MM/DD/YY** if there was an interruption during that directory download.

- Press **OK** to exit.

NOTE

- If a handset tries to access the directory while a Bluetooth directory download is in progress, the screen shows **Not available at this time**.

Remote voice control

If you have connected a cell phone to the **IS8151/IS8152** telephone system, you can activate the voice-controlled application (voice app) of the cell phone, such as Siri®, Google Now™ or S Voice®, using your handset or telephone base.

The remote voice control feature works with:

Voice-controlled application	Siri	Google Now	S Voice
Operation System (Versions supported)	iOS (8 or above)	Android (4 or above)	Android (4 or above)

Before using the remote voice control feature, make sure you checked the following:

- Your cell phone is paired and connected to your telephone system via Bluetooth.
- No Bluetooth applications are running in the background of your cell phone.
- Keep your cell phone within 15 feet of the telephone base.
- Do not lock up your cell phone's screen or set passcode for activating the voice app.
- Make sure you have turned on or logged in to the applications on your cell phone that you will be sending your voice commands, such as GPS, e-mail and social networking accounts.
- Your cell phone's data or Wi-Fi signal is in full strength and your cell phone can connect to the Internet.
- Try to activate the voice app on your cell phone to ensure it is in place.

Activate remote voice control

- Press **VOICE** on the handset or telephone base.
 - If you have connected two cell phones to the telephone, the telephone shows **Activate remote voice control of 1: Cell Phone X 2: Cell Phone Y** (Cell Phone X and Cell Phone Y represent the device names of your cell phones). Press **CELL1** or **CELL2**.
- The telephone then shows **Activating remote voice control...**
 - If the activation fails, the telephone displays **Connection timeout. Please check cell status..** Press **OK** and try again.
- When the telephone base or handset plays the confirmation tone as forwarded by the cell phone's voice app, start speaking toward the telephone base or handset, and then wait for feedback. Make reply to the voice app's feedback, if necessary.
 - You can press **⏏** on the handset to turn off the speakerphone and listen to the feedback through the handset earpiece.
- To end the current remote voice control session, press **END** on the telephone base or handset. You can restart by following Steps 1-3 mentioned above.

Siri® is a registered trademark of Apple Inc.
Google Now™ is a trademark of Google Inc.
S Voice® is a registered mark of Samsung Electronics Co., Ltd.

NOTES

- Once you have activated the remote voice control feature, you are using your cell phone's voice app to operate your cell phone.
- Please check the cell phone user's manual and the voice app's help topics to find out what commands you can use and any limitations of the voice app.
- Some cell phone manufacturers or network carriers may customize the phone's operating system and implement their own voice app. If you want to use Google Now, you need to manually set it as your default voice app. For detailed instructions, refer to your cell phone user's manual, or contact your cell phone's manufacturer or network carrier. You may also go to "Google Product Forums" on the Internet and check the corresponding help topics.
- Due to the settings of certain cell phones and voice apps, your cell phone may not support the remote voice control feature. Contact your cell phone's manufacturer or network carrier, or check the voice app's help topics if you encounter any problems.
- During the remote voice control activation, if your Android cell phone comes with both a dedicated voice app and Google Now, it may prompt you to select which voice app to use, and whether use it for just once or always. Select the desired options. If you do not respond to your cell phone's prompt in time, the telephone displays **Connection timeout. Please check cell status..** Press **OK** and try again.
- If the cell phone is in use, the telephone displays **Bluetooth system busy**.
- If you receive a landline or cell line incoming call when you have activated remote voice control on a connected cell phone, the remote voice control operation will be ended.
- The feature may be ended automatically by your cell phone. For example, a cell call has been established via the remote voice control feature and the call has just ended.
- If you need to press dialing keys (**0-9, TONEX, QUIET#**) during a cell call, please make the call using the cell lines of your telephone system instead of using the voice app via the remote voice control feature (see **Make, answer or end a cell call**).

Configure your telephone

Use the handset and telephone base menu

- Press **MENU** when the phone is not in use.
- Press **▼ CID** or **▲** until the screen displays the desired feature menu.
- Press **SELECT**.
 - To return to the previous menu, press **CANCEL**.
 - To return to idle mode, **press and hold CANCEL**.

Set language

The LCD language is preset to English. You can select English, French or Spanish to be used in all screen displays.

- Press **MENU** when the telephone is not in use.
- Press **▼ CID** or **▲** to choose **Settings** and then press **SELECT** twice.
- Press **▼ CID** or **▲** to choose **English, Français** or **Español**.
- Press **SELECT**, and then press **YES** to save your setting. You hear a confirmation tone.

Set date and time

NOTE

- Make sure you set the date and time including the year correctly; otherwise the answering system does not announce the correct day of the week for your recorded messages time stamp.
- Press **MENU** on the telephone when not in use.
 - Press **▼ CID** or **▲** to choose **Set date/time** and then press **SELECT**.
 - Use the dialing keys (**0-9**) to enter the month (**MM**), date (**DD**) and year (**YY**). Then press **SELECT**.
 - Use the dialing keys (**0-9**) to enter the hour (**HH**) and minute (**MM**). Then press **▼ CID** or **▲** to choose **AM** or **PM**.
 - Press **SELECT** to save your setting. You hear a confirmation tone.

Set voice language

NOTE

- This feature is exclusive for Canada version.

The voice prompt language is preset to English. You can select English or French to be used for the voice prompts in your answering system.

Using a cordless handset or the telephone base:

- Press **MENU** when the telephone is not in use.
- Press **▼ CID** or **▲** to choose **Settings**, then press **SELECT**.
- Press **▼ CID** or **▲** to scroll to **Voice language**, then press **SELECT**.
- Press **▼ CID** or **▲** to choose **English** or **Français** and then press **SELECT** to save. You hear a confirmation tone.

Caller ID announce

The caller ID announce feature lets you know who's calling without having to look at the display. When you have an incoming call, the handset and/or base speaks "Call from..." and the name of the caller based on the phonebook or caller ID information. If the caller's name is private or unknown, the phone number up to the last 11 digits will be announced. If the caller's phone number is also private or unknown, no information will be announced. The default setting is **On**.

To turn on or off the caller ID announce feature:

1. Press **MENU** when the telephone is not in use.
2. Press **▼ CID** or **▲** on the handset or telephone base to scroll to **Caller ID annnc**, then press **SELECT**.
3. Press **▼ CID** or **▲** on the handset or telephone base to highlight **On** or **Off**, then press **SELECT**. There is a confirmation tone.

Use caller ID to automatically set date and time

If you subscribe to caller ID service, the day, month and time are set automatically with each incoming call. Follow the steps mentioned below, to turn the **CID time sync** feature on or off. The default setting is **On**.

1. Press **MENU** when the telephone is not in use.
2. Press **▼ CID** or **▲** on the handset or telephone base to scroll to **Settings**, then press **SELECT**.
3. Press **▼ CID** or **▲** on the handset or telephone base to scroll to **CID time sync**, then press **SELECT**.
4. Press **▼ CID** or **▲** on the handset or telephone base to highlight **On** or **Off**, then press **SELECT**. There is a confirmation tone and the screen returns to the previous menu.

Set speed dial voicemail number

This feature lets you save your voicemail number for easy access when you press and hold the **1** key.

To save your voicemail number:

1. Press **MENU** when the telephone is not in use.
2. Press **▼ CID** or **▲** on the handset or telephone base to scroll to **Settings**, then press **SELECT**.
3. Press **▼ CID** or **▲** on the handset or telephone base to scroll to **Voicemail #**, then press **SELECT**.
4. Use the dialing keys to enter the voicemail access number provided by your telephone service provider (up to 30 digits) when prompted.
 - Press **▼ CID** or **▲** on the handset or telephone base to move the cursor to the left or right.
 - Press **MUTE/DELETE** on the handset, or press **DELETE** on the telephone base to erase a digit.
 - Press and hold **MUTE/DELETE** on the handset, or press and hold **DELETE** on the telephone base to erase all digits.
 - Press and hold **REDIAL/PAUSE** to enter a three-second dialing pause (a **p** appears).
5. Press **SAVE** to save. There is a confirmation tone and the screen displays **Voicemail #** saved, then returns to the previous menu.

Voicemail (visual message waiting) indicator

If you subscribe to a voicemail service offered by your telephone service provider, this feature provides a visual indication when you have new voicemail messages. **New voicemail** and **1** appear on the screens.

NOTES

- This feature does not indicate new messages recorded on your phone's built-in answering system.
- For more information about the difference between your answering system and voicemail, see **About the built-in answering system and voicemail service**.

Clear voicemail indication

Use this feature when the telephone indicates there is new voicemail but there is none. For example, when you have accessed your voicemail while away from home. This feature only turns off the displayed **New voicemail** and **1** icon; it does not delete your voicemail messages. As long as you have new voicemail messages, your telephone service provider continues to send the signal to turn on the indicators.

To manually turn off the new voicemail indicators:

1. Press **MENU** when the telephone is not in use.
2. Press **▼ CID** or **▲** on the handset or telephone base to scroll to **Settings**, then press **SELECT**.
3. Press **▼ CID** or **▲** on the handset or telephone base to scroll to **Clear voicemail**, then press **SELECT**. The screen shows **Reset Voicemail Indication?**.
4. Press **YES** to turn the voicemail indication off. There is a confirmation tone and the screen returns to the previous menu.

NOTES

- Your telephone service provider voicemail may alert you to new messages with a stutter (broken) dial tone. Contact your telephone service provider for more details.
- For information about using your voicemail service, contact your telephone service provider.

Home area code

If you dial local calls using only seven digits (area code not required), you can program your home area code so that when you receive a call within your local area, the telephone number is automatically stored in the caller ID log without the area code.

To set the home area code:

1. Press **MENU** when the telephone is not in use.
2. Press **▼ CID** or **▲** on the handset or telephone base to scroll to **Phonebook** and then press **SELECT**.
3. Press **OPTION** to choose **Home**.
4. Press **▼ CID** or **▲** on the handset or telephone base to scroll to **Home area code**, and then press **SELECT**. The screen displays the currently stored home area code.
5. Use the dialing keys (**0-9**) to enter the desired home area code.
 - Press **DELETE** to delete a digit.
 - Press and hold **DELETE** to delete all digits.
6. Press **SAVE** to confirm. You hear a confirmation tone.

NOTE

- If, in the future, your telephone service provider requires you to dial the area code when making a local call, or, if you move to a location that requires it, delete the home area code you have already programmed following the steps above. After you have deleted the home area code, ___ appears.

Cell area code

Most cell phone entries are stored in a 10-digit format. If all of your cell phone entries are stored this way, you do not need to program your cell area code.

If your cell phone stores entries in a 7-digit format, we recommend that you program your cell area code so that your 7-digit phonebook entries can be dialed correctly using your home line.

To set the cell area code:

1. Press **MENU** when the telephone is not in use.
2. Press **▼ CID** or **▲** on the handset or telephone base to scroll to **Phonebook** and then press **SELECT**.
3. Press **OPTION** to choose **Cell**.
4. Press **▼ CID** or **▲** on the handset or telephone base to scroll to **Cell area code**, and then press **SELECT**. The screen displays the currently stored home area code.
5. Use the dialing keys (**0-9**) to enter the desired home area code.
 - Press **DELETE** to delete a digit.
 - Press and hold **DELETE** to delete all digits.
6. Press **SAVE** to confirm. You hear a confirmation tone.

Dial mode

The dial mode is preset to touch-tone dialing. If you have pulse (rotary) service, you need to change the dial mode to pulse dialing before using the telephone.

1. Press **MENU** when the handset is not in use.
2. Press **▼ CID** or **▲** on the handset or telephone base to scroll to **Settings**, and then press **SELECT**.
3. Press **▼ CID** or **▲** on the handset or telephone base to scroll to **Dial mode**, then press **SELECT**.
4. Press **▼ CID** or **▲** on the handset or telephone base to scroll to **Touch-tone** or **Pulse**, then press **SELECT** to confirm your selection. You hear a confirmation tone.

Temporary tone dialing

If you have pulse (rotary) service only, you can switch from pulse to touch-tone dialing temporarily during a call. This is useful if you need to send touch-tone signals to access your telephone banking or long distance services.

1. During a call, press **TONE~~X~~**.
2. Use the dialing keys to enter the number. The telephone sends touch-tone signals. It automatically returns to pulse dialing mode after you end the call.

No line alert

If there is no telephone line connected to the telephone base, the screens show **No home line**. If you do not want to display this message on the screens (for example, if you use the cell line only), you can turn the no line alert off using the code, as described below.

To turn off the no line alert:

Press **MENU** on the handset or telephone base in idle mode, then enter ***662#**. You hear a confirmation tone.

To turn the no line alert back on:

Press **MENU** on the handset or telephone base in idle mode, then enter ***661#**. You hear a confirmation tone.

Cell alert

If you have downloaded the **Connect to Cell** application and use the **Alerts manager**, there are message notifications sent to your telephone system. Your telephone system beeps once when your Android cell phone receives text messages, e-mails or social media updates. You can turn the alert tone on or off using the code, as described below.

To turn the alert tone off:

Press **MENU** on the handset or telephone base, then enter ***252#**. You hear a confirmation tone.

To turn the alert tone back on:

Press **MENU** on the handset or telephone base, then enter ***251#**. You hear a confirmation tone.

Telephone operations

Handset control key panel:

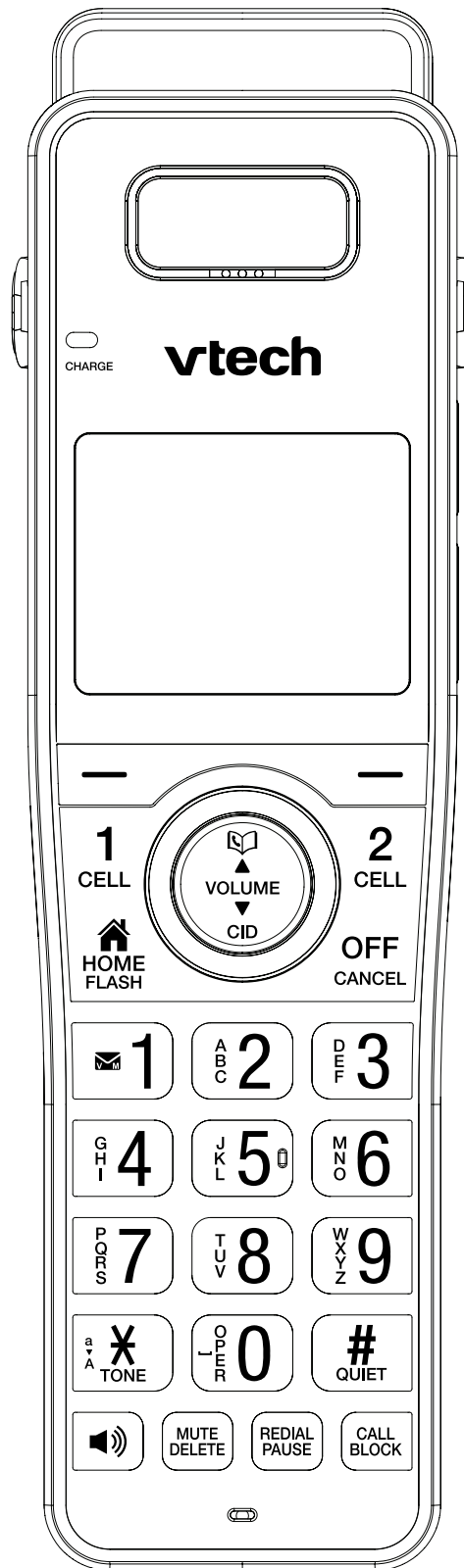

Make, answer or end a home call

Using a cordless handset:

To make a home call:

- Press **HOME/FLASH** or **[Speaker]**, then enter the telephone number.

To predial a home call:

- Enter the telephone number, then press **HOME/FLASH** or **[Speaker]**.

To answer a home call:

- Press **HOME/FLASH** or **[Speaker]**, **CELL 1**, **CELL 2** or any dialing key (**0-9** or **TONEX**).

To end a home call:

- Press **OFF/CANCEL**, or put the handset in the telephone base or charger.

Using the telephone base:

To make a home call:

- Press **HOME** on the telephone base, then enter the telephone number.

To predial a home call:

- Enter the telephone number, then press **HOME**.

To answer a home call:

- Press **HOME**, **CELL 1**, **CELL 2** or any dialing key (**0-9** or **TONEX**).

To end a home call:

- Press **HOME**.

NOTES

- The screen shows the elapsed time as you talk (in hours, minutes and seconds).
- When predialing (preview numbers before dialing), press **DELETE** to backspace and delete; press and hold **REDIAL/PAUSE** to insert a dialing pause (a **p** appears).
- You cannot answer a home call using your connected cell phone.

Using a Bluetooth headset:

You can use a Bluetooth headset for home calls. However, you need to keep the device within 15 feet of the telephone base for optimal performance. Please see the user's manual of your Bluetooth headset for more information.

To answer a home call using a Bluetooth headset:

- Press the call key on your headset.

To end a home call using a Bluetooth headset:

- Press the call key on your headset.

To transfer a call from the telephone base to a Bluetooth headset:

- Press **OPTION** on the telephone base, then press **▼ CID** or **▲ [Speaker]** to highlight **Use BT Headset** and then press **SELECT**. The telephone base displays **Transferring audio to Headset A**.

Call waiting on the home line

If you subscribe to call waiting service from your telephone service provider, and someone calls while you are already on a call, you hear a tone.

- Press **HOME/FLASH** on the handset, or press **PTT/FLASH** on the telephone base to put your current call on hold and take the new call.

NOTES

- If the Smart call blocker feature is on and in screening mode, and you receive a call waiting home call:
 - If you have already picked up a screened home call, the telephone checks whether the call waiting call's number can be found in the phonebook, block list or allow list. It also checks whether the caller name is in the star name list. After that, the telephone displays the caller ID information or **Blocked call** accordingly. You can press **HOME/FLASH** or **[Speaker]** to take the new call.
 - If the telephone is screening a home call, the call waiting call will be ignored and logged as missed call in the caller ID log.
- The screening feature of Smart call blocker is applicable to home calls only:

Make, answer or end a cell call

The IS8151/IS8251 can be used to make or answer calls on the cell line. You can connect a maximum of 4 Bluetooth enabled cell phones to the telephone base. Both cell phones can be used on cell calls at the same time.

Using a cordless handset:

To make a cell call:

- Press **CELL 1** or **CELL 2**. Enter the telephone number, then press **DIAL**.

To predial a cell call:

- Enter the telephone number, then press **CELL 1** or **CELL 2**.

To answer a cell call:

- Press **HOME/FLASH** or **[Speaker]**, **CELL 1**, **CELL 2** or any dialing key (**0-9** or **TONEX**).

To end a cell call:

- Press **OFF/CANCEL**, or put the handset in the telephone base or charger.

Using the telephone base:

To make a cell call:

- Press **CELL 1** or **CELL 2** on the telephone base. Enter the telephone number, then press **DIAL**.

To predial a cell call:

- Enter the telephone number, then press **CELL 1** or **CELL 2**.

To answer a cell call:

- Press **HOME**, **CELL 1**, **CELL 2** or any dialing key (**0-9** or **TONEX**).

To end a cell call:

- Press **CELL 1** or **CELL 2**.

NOTES

- You can also use your cell phone to answer the call. If you answer with your cell phone, it disconnects from the telephone base.
- If you do not want to answer the call, press **REJECT**.
- When you try to make a cell call but your cell phone is not connected to the base, the telephone base displays **Cellular phone not connected. Please connect to proceed.** Press **CONNECT** to connect your cell phone to the telephone system. Refer to **Bluetooth connection from idle mode** and **Connect/disconnect an active device**.
- Make a cell call using the cell lines of your telephone system instead of the remote voice control feature, if you need to press dialing keys (**0-9**, **TONEX**, **QUIET#**) during a call.

Call waiting on the cell line

If you subscribe to call waiting service from your cell phone service provider, and someone calls while you are already on a call, you hear a beep.

Using a cordless handset:

- Press **CELL 1** or **CELL 2** to put your current call on hold and take the new call.
- Press **CELL 1** or **CELL 2** at any time to switch back and forth between calls.

-OR-

- Press **SWAP** to switch. To switch back, press **CELL 1** or **CELL 2**.

Using the telephone base:

- Press **SWAP** on the telephone base. The original call is put on hold and you take the new call.
- Press **OPTION** on the telephone base. Press **▼ CID** or **▲ [Speaker]** to highlight **Swap Cell X**. Press **SELECT** to resume the original call. The other incoming cell call is put on hold.

NOTES

- If the Smart call blocker feature is on and in screening mode, and you receive a call waiting cell call:
 - If you have already picked up a screened home call, the telephone checks whether the call waiting cell call's number can be found in the block list. If yes, the telephone displays **Blocked call** and rejects the call.
- The screening feature of Smart call blocker is applicable to home calls only.

Answer an incoming cell call while on a home call

If you are on a home call and you receive an incoming cell call, you hear a beep and **1** or **2** displays on the handset or telephone base you are using. The telephone base and all other handsets ring.

To answer the incoming cell call:

Using a cordless handset or the telephone base:

- Press **CELL 1** or **CELL 2**. The home call is automatically placed on hold; all other handsets and the telephone base display **Home call on hold** and **Cell 1/2 line in use**, alternately.

To end the cell call:

Using a cordless handset:

- Press **OFF/CANCEL** on the handset. The home line is still on hold. The telephone base and all other handsets display **Home call on hold**.

Using the telephone base:

- Press **CELL 1** or **CELL 2** on the telephone base. The home line is still on hold. All handsets display **Home call on hold**.

To resume the home call on hold:

Using a cordless handset:

- Press **HOME/FLASH** on the handset.

Using the telephone base:

- Press **HOME** on the telephone base.

Answer a home call while on a cell call

If you are on a cell call and you receive an incoming home call, you hear a beep and **HOME** displays on the handset or telephone base you are using. The telephone base and all other handsets ring.

To answer the incoming home call:

Using a cordless handset:

- Press **HOME/FLASH** on the handset. The cell call is automatically placed on hold and the telephone base display **Cell 1/2 call on hold** and **Home line in use**, alternately.

Using the telephone base:

- Press **HOME** on the telephone base. The cell call is automatically placed on hold. All handsets display **Cell 1/2 call on hold** and **Home line in use**, alternately.

To end the home call:

Using a cordless handset:

- Press **OFF/CANCEL** on the handset. The cell line is still on hold. The telephone base and all handsets display **Cell 1/2 call on hold**.

Using the telephone base:

- Press **HOME** on the telephone base. The cell line is still on hold. The telephone base and all handsets display **Cell 1/2 call on hold**.

To resume the cell call on hold:

Using a cordless handset:

- Press **CELL 1** or **CELL 2** on the handset.

Using the telephone base:

- Press **CELL 1** or **CELL 2** on the telephone base.

NOTE

- If you have turned on your answering system and you do not answer the incoming home call, the call is answered by your answering system.

Conference home and cell calls

When you have calls established on the home and cell lines, you can create a 3-way conference.

To conference both home and cell calls:

- Press **OPTION** on the handset or telephone base.
- Press **▼ CID** or **▲** on the handset or telephone base to highlight **Conference**.
- Press **SELECT**. The conferencing device's screen displays **Conf**.

To select an option while on a conference call:

- Press **OPTION** on the handset or telephone base.
- Press **▼ CID** or **▲** on the handset or telephone base to highlight one of the following options:
 - Hold**
 - End Home line**
 - End Cell 1/2 line**
 - Equalizer**
 - Caller ID log**
 - Phonebook**
- Press **SELECT**.

To end a conference call:

- Press **OFF/CANCEL** on the handset or **HOME** on the telephone base. You can also put the handset back in the telephone base or charger.

Using the home and cell lines together:

- You can be on two different calls at the same time using the cell line and home line with two handsets.
- You can be on a call using the cell line and a Bluetooth headset via the home line at the same time.
- If you are on a call using the cell line, you cannot join the call using your paired cell phone. However, you can join the call using another **IS8151/IS8251** device. Your cell phone is being used for the phone call so only features that are normally available during a call can be used.
- Press the same key at any time to switch back and forth between calls.

Handset speakerphone

During a call, press **Speakerphone** on the handset to switch between the speakerphone and normal handset use. In speakerphone mode, press **OFF/CANCEL** or return the handset to the telephone base or charger to hang up.

Volume

While on a call, you can adjust the listening volume on the handset or telephone base.

If it is a cell call and the volume is too loud, too quiet or drops out, try changing the volume on your cell phone. On some cell phones, changing the volume on the cell phone affects your cell call volume on the **IS8151/IS8251** handsets or telephone base.

To adjust the listening volume of a handset:

- Press **▲ VOLUME ▼** on the handset while on a call.

To adjust the listening volume of the telephone base:

- Press **+ VOL -** on the telephone base while on a call.

NOTE

- The handset earpiece volume setting (1-6) and speakerphone volume setting (1-6) are independent. The speakerphone volume setting of the telephone base (1-8) is also independent.

Silence the ringer

When the telephone is ringing, you can temporarily silence the ringer of the handset or telephone base without disconnecting the call. The next call rings normally at the preset volume.

To silence the handset ringer:

- Press **MUTE**, **OFF/CANCEL**, **MUTE/DELETE** or **QUIET #** on the handset. The handset screen shows **Ringer muted**.

To silence the base ringer:

- Press **MUTE**, **MUTE**, **CANCEL** or **QUIET #**. The telephone base displays **Ringer muted**.

Mute

Use the mute function to turn off the microphone. You can hear the caller, but the caller cannot hear you.

Using a cordless handset:

To mute a call:

- While on a call, press **MUTE/DELETE**. When mute is on, the handset shows **Muted** for a few seconds and **MUTE** icon displays until you turn off mute.

To end mute a call:

- Press **MUTE/DELETE** again. When mute is off, **Microphone ON** appears temporarily on the handset.

Using the telephone base:

To mute a call:

- While on a call, press **MUTE**. When mute is on, the **MUTE** light turns on. The telephone base shows **Muted** for a few seconds and **MUTE** icon displays until you turn off mute.

To end mute a call:

- Press **MUTE** again. When mute is off, **Microphone ON** appears temporarily on the telephone base.

Mute is automatically canceled when you end the call.

Hold

You can place any call on hold. You hear an alert tone at the telephone base if you have not taken the call off of hold after 14 minutes. You hear another alert tone at the telephone base 30 seconds later. At 15 minutes on hold, the call on hold automatically disconnects.

To place a home call on hold:

- While on a home call, press **OPTION**, and then press **SELECT** on the handset or telephone base to select **HOLD**. **Home call on hold** appears on the handsets and telephone base. **HOME/FLASH** flashes on the handsets and **HOME** flashes on the telephone base.

To resume a home call on hold:

- Press **HOME/FLASH** on handsets or **HOME** on the telephone base.

To place a cell call on hold:

- While on a cell call, press **OPTION**, and then press **SELECT** on the handset or telephone base to select **HOLD**. **Cell 1/2 call on hold** appears on the handsets and telephone base. **CELL 1** or **CELL 2** on the handset or telephone base flashes.

To resume a cell call on hold:

- Press **CELL 1** or **CELL 2** on the handset or telephone base.

Equalizer

The equalizer feature enables you to change the quality of the audio to best suit your hearing.

Using a cordless handset or the telephone base:

- While on a home call or cell call, press **OPTION**.
- Press **▼ CID** or **▲** to scroll to **Equalizer**, then press **SELECT**.
- Press **▼ CID** or **▲** to scroll to the handset or telephone base to select **Treble 1**, **Treble 2**, **Bass** or **Natural** (the default setting), then press **SELECT**.

NOTE

- If you switch the call between the handset and speakerphone by pressing **⏸**, the audio setting remains unchanged.
- The current equalizer setting remains unchanged until you select a new setting.

Join a call in progress (for multiple handset models only)

Another handset can join you on an outside call. The call continues until all people hang up. You can share an outside call with telephone base and up to 4 system handsets.

To join a home call:

Using a cordless handset:

- Press **HOME/FLASH** or **⏸** on another handset to join the call.

Using the telephone base:

- Press **HOME** to join the call.

To join a cell call:

Using a cordless handset:

- Press **CELL 1** or **CELL 2** on another handset to join the call.

Using the telephone base:

- Press **CELL 1** or **CELL 2** to join the call.

Chain dialing

Use this feature to initiate a dialing sequence from the numbers in the phonebook, caller ID log or redial memory while you are on a call.

Chain dialing is useful when you wish to access other numbers (such as bank account numbers or access codes) from the phonebook, caller ID log or redial list.

Using a cordless handset:

To access a number in the phonebook while on a call:

- Press **OPTION**.
- Press **▼ CID** or **▲** to scroll to **Phonebook**, then press **SELECT**.
- Press **▼ CID** or **▲** to scroll to the desired entry, then press **REVIEW**.
- Press **▼ CID** or **▲** to highlight the desired entry or perform an alphabetical search (See **3-character alphabetical search**).
- Press **DIAL** to dial the number shown.

To access a number in the caller ID log while on a call:

- Press **OPTION**.
- Press **▼ CID** or **▲** to scroll to **Caller ID log**, then press **SELECT**.
- Press **▼ CID** or **▲** to scroll to the desired entry, then press **CALL** to dial the number shown.

To access a number in the redial list while on a call:

- Press **REDIAL/PAUSE** to show the most recently dialed number.
- Press **▼ CID** or **▲** to scroll to the desired number, or press **REDIAL/PAUSE** repeatedly to find the desired number. Press **DIAL** to dial the number shown.

Using the telephone base:

To access the phonebook while on a call:

- Press **OPTION**.
- Press **▼ CID** or **▲** to scroll to **Phonebook** and then press **SELECT**.
- Press **▼ CID** or **▲** to scroll to the desired entry, then press **REVIEW**.
- Press **▼ CID** or **▲** to scroll to the desired entry. Press **DIAL** to dial the number shown.

To access the caller ID log while on a call:

- Press **OPTION**.
- Press **▼ CID** or **▲** to scroll to **Caller ID log** and then press **SELECT**.
- Press **▼ CID** or **▲** to scroll to the desired number.
- Press **CALL** to dial the number shown.

To access the redial list while on a call:

- Press **REDIAL/PAUSE** to show the most recently dialed number.
- Press **▼ CID** or **▲** to scroll to the desired number, or press **REDIAL/PAUSE** repeatedly to find the desired number. Press **DIAL** to dial the number shown.

NOTES

- You cannot edit a phonebook entry while on a call. Refer to the **Phonebook** section for more details.
- You cannot copy a caller ID log entry into the phonebook while on a call. Refer to the **Caller ID** section for more details.
- You cannot erase a redial entry while on a call. Refer to the **Redial list** section for more details.
- Press **CANCEL** to exit redial, phonebook or caller ID log when you are on a call.

Find handset

Use this feature to find the system handset.

To start paging:

- Press **FIND HS** on the telephone base when not in use. All idle handsets ring and display **** Paging ****.

To end paging:

- Press **HOME/FLASH**, or any dialing key (**0-9**, **TONE**) on the handset(s).

-OR-

- Press **FIND HS**, **MUTE**, **CANCEL** or **STOP** on the telephone base.

NOTES

- Press **MUTE** to turn off the ringer of a handset temporarily. Paging tone continues on the other handset.
- Do not press and hold **FIND HS** for more than four seconds. It may lead to handset deregistration. If the handset displays **To register HS** and **See manual**, refer to the **Register a handset** section to register the handset back to the telephone base.

Redial list

The telephone base and each handset store the last 10 dialed numbers (up to 30 digits each) in the redial list. The redial entries of each handset and the telephone base are independent.

Review a redial list entry

To review the redial list of a handset:

- Press **REDIAL/PAUSE** in idle mode.
- Press **▼ CID**, **▲** or **REDIAL/PAUSE** repeatedly to browse through the list. The handset beeps twice at the end of the list.
- Press **OFF/CANCEL** to exit.

To review the redial list of the telephone base:

- Press **REDIAL/PAUSE** in idle mode.
- Press **▼ CID**, **▲** or **REDIAL/PAUSE** repeatedly to browse through the list. The telephone base beeps twice at the end of the list.
- Press **CANCEL** to exit.

Dial a redial list entry

To dial a redial entry on a handset:

- Press **HOME/FLASH**, or to use the home line, then press **REDIAL/PAUSE** to enter the redial list.
- Press **▼ CID**, **▲** or **REDIAL/PAUSE** repeatedly to browse until the desired number displays. The handset beeps twice at the end of the list.
- Press **DIAL** to dial the number displayed.

-OR-

- Press **CELL 1** or **CELL 2** to use the cell line, then press **REDIAL/PAUSE** to enter the redial list.
- Press **▼ CID**, **▲** or **REDIAL/PAUSE** repeatedly to browse until the desired number displays. The handset beeps twice at the end of the list.
- Press **INSERT** to insert the desired number.
- Press **DIAL** to dial the number displayed.

-OR-

You can also select a redial entry before dialing.

- Press **REDIAL/PAUSE** in idle mode.
- Press **▼ CID**, **▲** or **REDIAL/PAUSE** repeatedly to browse until the desired number displays. The handset beeps twice at the end of the list.
- Press **HOME/FLASH**, or to call using the home line, or **CELL 1**, **CELL 2** to call using the cell line.

-OR-

You can insert the area code to the redial number before dialing.

- Enter the area code in idle mode, then press **REDIAL/PAUSE**.
- Press **▼ CID**, **▲** or **REDIAL/PAUSE** repeatedly to browse until the desired number displays, then press **INSERT**. The area code will be added in front of the selected redial number.
- Press **HOME/FLASH**, or to call using the home line, or **CELL 1**, **CELL 2** to call using the cell line.

To dial a redial entry on the telephone base:

- Press **HOME** to use the home line, then press **REDIAL/PAUSE** to enter the redial list.
- Press **▼ CID**, **▲** or **REDIAL/PAUSE** repeatedly to browse until the desired number displays. The handset beeps twice at the end of the list.
- Press **DIAL** to dial the number displayed.

-OR-

- Press **CELL 1** or **CELL 2** to use the cell line, then press **REDIAL/PAUSE** to enter the redial list.
- Press **▼ CID**, **▲** or **REDIAL/PAUSE** repeatedly to browse until the desired number displays. The handset beeps twice at the end of the list.
- Press **INSERT** to insert the desired number.
- Press **DIAL** to dial the number displayed.

You can also select a redial entry before dialing.

- Press **REDIAL/PAUSE** in idle mode.
- Press **▼ CID**, **▲** or **REDIAL/PAUSE** repeatedly to browse until the desired number displays. The telephone base beeps twice at the end of the list.
- Press **HOME** to call using the home line, or **CELL 1** or **CELL 2** to call using the cell line.

-OR-

You can insert the area code to the redial number before dialing.

- Enter the area code in idle mode, then press **REDIAL/PAUSE**.
- Press **▼ CID**, **▲** or **REDIAL/PAUSE** repeatedly to browse until the desired number displays, then press **INSERT**. The area code will be added in front of the selected redial number.
- Press **HOME** to call using the home line, or **CELL 1**, **CELL 2** to call using the cell line.

Save a redial entry to the phonebook

Using a cordless handset:

- Press **REDIAL/PAUSE** in idle mode.
- Press **▼ CID**, **▲** or **REDIAL/PAUSE** repeatedly to browse until the desired number displays.
- Press **SAVE**.
- The screen displays **Edit number**. Use the dialing keys to edit the number, if necessary.
 - Press **MUTE/DELETE** or **BACKSP** to erase a digit.
 - Press and hold **MUTE/DELETE** to erase all digits.
 - Press **▼ CID** or **▲** to move the cursor to the right or left.
 - Press and hold **REDIAL/PAUSE** to insert a dialing pause (a **p** appears).
- Press **NEXT**.
- Press **▼ CID** or **▲** to highlight one of the following types:
 - Home
 - Cell
 - Work
 - Other
- Press **NEXT**. The screen displays **Enter name**. Use the dialing keys to enter a name.
 - Press **MUTE/DELETE** or **BACKSP** to erase a character.
 - Press and hold **MUTE/DELETE** to erase all characters.
 - Press **▼ CID** or **▲** to move the cursor to the right or left.
- Press **SAVE**. You hear a confirmation tone.

Using the telephone base:

- Press **REDIAL/PAUSE** in idle mode.
- Press **▼ CID**, **▲** or **REDIAL/PAUSE** repeatedly to browse until the desired number displays.
- Press **SAVE**.
- The screen displays **EDIT NUMBER**. Use the dialing keys to edit the number, if necessary.
 - Press **DELETE** or **BACKSP** to erase a digit.
 - Press and hold **DELETE** to erase all digits.
 - Press **▼ CID** or **▲** to move the cursor to the right or left.
 - Press and hold **REDIAL/PAUSE** to insert a dialing pause (a **p** appears).
- Press **NEXT**.
- Press **▼ CID** or **▲** to highlight one of the following types:
 - Home
 - Cell
 - Work
 - Other
- Press **NEXT**. The screen displays **ENTER NAME**. Use the dialing keys to enter a name.
 - Press **DELETE** or **BACKSP** to erase a character.
 - Press and hold **DELETE** to erase all characters.
 - Press **▼ CID** or **▲** to move the cursor to the right or left.
- Press **SAVE**. You hear a confirmation tone.

Delete a redial list entry

1. Press **REDIAL/PAUSE** on the handset or telephone base in idle mode.
2. Press **▼ CID** or **▲** on the handset or telephone base.

-OR-

Press **REDIAL/PAUSE** repeatedly to browse until the desired number displays.

3. Press **MUTE/DELETE** on the handset or **DELETE** on the telephone base to delete the displayed number. You hear a confirmation tone.

Sound settings

Key tone

You can turn the key tone on or off.

1. Press **MENU** in idle mode to enter the main menu.
2. Press **▼ CID** or **▲** on the handset or telephone base to scroll to **Settings**, then press **SELECT**.
3. Press **▼ CID** or **▲** on the handset or telephone base to scroll to **Key tone**, then press **SELECT**.
4. Press **▼ CID** or **▲** on the handset or telephone base to select the desired volume or **Off**.
5. Press **SET** to save your preference. There is a confirmation tone and the screen returns to the previous menu.

Ringer tone

You can select the ringer tones for incoming home and cell calls.

To select a ringer tone:

1. Press **MENU** on the handset or telephone base in idle mode to enter the main menu.
2. Press **▼ CID** or **▲** on the handset or telephone base to scroll to **Ringers**, then press **SELECT**.
3. Press **▼ CID** or **▲** on the handset or telephone base to scroll to **Ringer tone**, then press **SELECT**.
4. Press **▼ CID** or **▲** on the handset or telephone base to highlight **All lines**, **Home**, **Cell 1** or **Cell 2**, then press **SELECT**.
5. Press **▼ CID** or **▲** on the handset or telephone base to sample each ringer tone. A sample of each ringer tone plays as you scroll through the choices.
6. Press **SELECT** to select and save your choice. You hear a confirmation tone.

NOTE

- If you turn off the ringer volume, you will not hear ringer tone samples.

Ringer volume

You can set the ringer volume for incoming calls on all lines. A ringer off icon  shows when the volume is set to off.

1. Press **MENU** on the handset or telephone base in idle mode to enter the main menu.
2. Press **▼ CID** or **▲** on the handset or telephone base to scroll to **Ringers**, then press **SELECT**.
3. Press **SELECT** again to select **Ringer volume**.
4. Press **▼ CID** or **▲** on the handset or telephone base to sample each volume level.
5. Press **SET** to save your preference. There is a confirmation tone and the screen returns to the previous menu.

-OR-

1. Press **+VOL -** on the telephone base to set the ringer volume of the telephone base while it is in idle mode.
2. Press **SET** to confirm and you hear a confirmation tone.

NOTES

- Changing the handset ringer volume does not affect the base ringer volume.
- If the ringer volume is set to off, that handset or the telephone base is silenced for all incoming calls.
- The ringer volume level also determines the ringer levels of intercom calls.
- If the ringer volume is set to off, the caller ID will not be announced and the screen will briefly display **Caller ID won't be announced**.

QUIET mode

When **QUIET** mode is turned on, the telephone silences all sounds during the set period of time (1-12 hours). However, the handset locator paging tone and any sound-generating operations initiated by users, such as making calls using the speakerphone or setting ringer volume, will sound as normal. After you turn on **QUIET** mode, this feature activates immediately and the answering system turns on automatically.

When **QUIET** mode is on, the answering system takes calls and records messages without broadcasting them.

To turn QUIET mode on:

1. Press and hold **QUIET #** in idle mode to enter the **QUIET** mode setting screen. The screen shows **Set quiet mode duration (1 to 12 hours) _ _**.
2. Use the dialing keys to enter the desired number of hours (1-12) you would like to turn on **QUIET** mode, then press **SELECT**. Your screen briefly shows **Answering sys is ON during quiet mode** and then **Quiet mode on** in the idle screen.

To turn QUIET mode off:

- While **QUIET** mode is on, press and hold **QUIET #**. The screen shows **Quiet mode is off** and you hear a confirmation tone.

NOTES

- If you change the base ringer, handset ringer, ringer volume, key tone, or caller ID announce features when **QUIET** mode is on, the sample plays but the feature is still muted after saving the setting.
- After **QUIET** mode is turned off or the set period of time has expired, all muted features will be activated again.
- The PTT function is not available when **QUIET** mode is on.
- When **QUIET** mode is on, and Smart call blocker is on and in screening mode, all screened home calls will be sent to the answering system after screening. For more information on Smart call blocker, see **About Smart call blocker**.

Temporary ringer silencing

When the telephone is ringing, you can temporarily silence the ringer of the handset or telephone base without disconnecting the call. The next call rings normally at the preset volume.

To silence the handset ringer:

- Press **MUTE**, **OFF/CANCEL**, **MUTE/DELETE** or **QUIET #** on the handset. The handset screen shows **Ringer muted**.

To silence the telephone base ringer:

- Press **MUTE**, **MUTE**, **CANCEL** or **QUIET #**. The telephone base displays **Ringer muted**.

Intercom

Use the intercom feature for conversations between two handsets, a handset and the telephone base, or a handset/telephone base and a cordless headset (sold separately). You can buy additional expansion handsets (**IS8101**, sold separately) to expand your telephone system (up to 12 handsets or 10 cordless handsets and two cordless headsets).

Using a cordless handset:

1. Press **MENU** in idle mode to enter the main menu. Press **▼ CID** or **▲** to scroll to **Intercom**, then press **SELECT**.
 - If you have one handset and no other registered devices, the handset shows **Calling base**.
 - If you have other registered device(s) or more than one handset, the handset shows **INTERCOM TO:**. Use the dialing keys to enter a specific device number (**0** for the telephone base, **1-9** for handsets 1-9, **TONEX** followed by **0-2** for handsets 10-12, or **#** for a single headset, **#** followed by **1** or **2** for headset 1 or 2, or **TONEX** followed by **#** for all devices), or press **▼ CID** or **▲** to scroll to the desired device and press **SELECT**. Your handset screen shows **Calling HANDSET X**, **Calling BASE 0**, **Calling headset** or **Calling all devices**.

The destination device(s) rings and shows **HANDSET is calling**, **HANDSET X is calling** or **HANDSET X is calling all** (**HANDSET** represents the handset name, **X** represents the handset number).

2. To answer the intercom call, press **HOME/FLASH**, **CELL 1**, **CELL 2** or any dialing key (**0-9**, **TONEX**) on the destination handset, or press **HOME** on the telephone base. Both devices now show **Intercom**.
3. To end the intercom call, one party presses **END**, **OFF/CANCEL**, or places the handset back in the telephone base or charger; or one party presses **END** on the telephone base. The other party hears four beeps. Both devices display **Intercom ended**.

Using the telephone base:

1. Press **MENU** in idle mode to enter the main menu. Press **▼ CID** or **▲** to scroll to **Intercom**, then press **SELECT**.
 - If you have one handset and no other registered devices, the telephone base shows **Calling HANDSET X**.
 - If you have other registered device(s) or more than one handset, the telephone base shows **INTERCOM TO:**. Use the dialing keys to enter a specific device number (**1-9** for handsets 1-9, **TONEX** followed by **0-2** for handsets 10-12, or **#** for a single headset, **#** followed by **1** or **2** for headset 1 or 2, or **TONEX** followed by **#** for all devices), or press **▼ CID** or **▲** to scroll to the desired device and press **SELECT**. The telephone base shows **Calling HANDSET X** or **Calling all**.

The destination device(s) rings and shows **Base is calling**, **BASE 0 is calling** or **BASE 0 is calling all**.

2. To answer the intercom call, press **HOME**, **CELL 1**, **CELL 2** or any dialing key (**0-9**, **TONEX**) on the telephone base. Both base and handset now show **Intercom**.
3. To end the intercom call, one party presses **END**, **CANCEL**, or places the handset back in the telephone base or charger; or one party presses **END** on the telephone base.

The other party hears four beeps. Both devices display **Intercom ended**.

NOTES

- Before the intercom call is answered, you can cancel it by pressing **OFF/CANCEL** on the handset or **END** on the telephone base.
- If the called party does not answer within 100 seconds, or if the device is in use, on a call or out of range, the initiating device shows **No answer. Try again..**
- To temporarily silence the intercom ringer, press **OFF/CANCEL** or **MUTE/DELETE** on the handset, or press **CANCEL** or **MUTE** on the telephone base.
- You can only use one pair of devices at a time to make intercom calls.
- For cordless headsets and speakerphones, refer to the corresponding user's manual on how to answer and end an intercom call.
- If a total of two cordless headset(s) and/or speakerphone(s) are registered to the telephone base, they appear as **HEADSET 1** and **HEADSET 2**, respectively, in the intercom menu.

Answer an incoming call during an intercom call

When you receive an incoming home call during an intercom call, the two handsets on the intercom call hear an alert tone.

To answer a home call during an intercom call:

Using a cordless handset:

- Press **HOME/FLASH** to answer the home call. The intercom call ends automatically.
- Press **OFF/CANCEL** to end the intercom call without answering the incoming call. The telephone continues to ring. You can press **HOME/FLASH** to answer the call.

Using the telephone base:

- Press **HOME** to answer the home call and the intercom call ends automatically.
- Press **BACK** and then **END** to end the intercom call without answering the incoming call. The telephone continues to ring. You can press **HOME** to answer the call.

To answer a cell call during an intercom call:

When you receive an incoming cell call during an intercom call, the two handsets on the intercom call hear an alert tone.

Using a cordless handset or telephone base:

- Press **CELL 1** or **CELL 2** to answer the cell call and the intercom call ends automatically.

NOTES

- If Smart call blocker is on and in screening mode, the telephone will screen incoming calls with numbers that are not saved in your phonebook or allow list, or with names that are not saved in the star name list. See **About Smart call blocker**.
- For cordless headsets and speakerphones, refer to the corresponding user's manual on how to answer an incoming call during an intercom call.

Call transfer using intercom

Use the intercom feature to transfer an outside call to another system handset or the telephone base. You can also share an outside call with another system handset or the telephone base.

Using a cordless handset:

1. During the call, press **OPTION**.
2. Press **▼ CID** or **▲** to scroll to **Intercom**, then press **SELECT**.
 - If you have one handset and no other registered devices, the handset shows **Calling base**.
 - If you have other registered device(s) or more than one handset, the handset shows **INTERCOM TO:**. Use the dialing keys to enter a specific device number (**0** for the telephone base, **1-9** for handsets 1-9, **TONE~~X~~** followed by **0-2** for handsets 10-12, or **#** for a single headset, **#** followed by **1** or **2** for headset 1 or 2, or **TONE~~X~~** followed by **#** for all devices), or press **▼ CID** or **▲** to scroll to the desired device and press **SELECT**.

The call is automatically put on hold. Your handset screen shows **Calling HANDSET X**, **Calling BASE 0**, or **Calling all**. The destination device rings and shows **HANDSET X is calling** or **HANDSET X is calling all**.

3. To answer the intercom call, press **HOME/FLASH**, **CELL 1**, **CELL 2** or any dialing key (**0-9**, **TONE~~X~~**) on the destination handset, or press **HOME** on the telephone base.
4. From this intercom call, you have the following options:
 - You can transfer the call. Press **OPTION** and then press **SELECT** to select **Transfer** on the calling handset. Your screen shows **Call transferred**. The other device automatically connects to the outside call.
 - You can let the other device join you on the outside call in a three-way conversation. Press **OPTION**. Press **▼ CID** or **▲** to highlight **Share call**, then press **SELECT**.
 - You can end the intercom call and continue the outside call with your handset. Press **OFF/CANCEL**, **END**, **HOME/FLASH**, **CELL 1** or **CELL 2** on your handset (the ended intercom call party hears four beeps).

NOTES

- If you want to cancel an intercom call and reconnect to the outside call before the destination handset answers, press **OFF/CANCEL** on the originating handset.
- If the called device is not answered within 100 seconds, or if the device is in use, on a call or out of range, the initiating device shows **No answer. Try again..**

Using the telephone base:

1. During the call, press **OPTION**.
2. Press **▼ CID** or **▲** to scroll to **Intercom**, then press **SELECT**.
 - If you have one handset and no other registered devices, the telephone base shows **Calling HANDSET**.
 - If you have other registered device(s) or more than one handset, the telephone base shows **INTERCOM TO:**. Use the dialing keys to enter a specific device number (**1-9** for handsets 1-9, **TONE~~X~~** followed by **0-2** for handsets 10-12, or **#** for a single headset, **#** followed by

1 or **2** for headset 1 or 2, or **TONE~~X~~** followed by **#** for all devices), or press **▼ CID** or **▲** to scroll to the desired device and press **SELECT**.

The call is automatically put on hold. The telephone base shows **Calling HANDSET X** or **Calling all**. The destination handset(s) rings and shows **BASE 0 is calling**.

3. To answer the call on any destination handset, press **HOME**, **CELL 1**, **CELL 2** or any dialing key (**0-9**, **TONE~~X~~**) on the telephone base. Both base and handset now show **Intercom**.
4. From this intercom call, you have the following options:
 - You can transfer the call. Press **OPTION** and then press **SELECT** to select **Transfer** on the telephone base. The telephone base shows **Call transferred**. The destination handset automatically connects to the outside call.
 - You can let the handset join you on the outside call in a three-way conversation. Press **OPTION**. Press **▼ CID** or **▲** to highlight **Share call**, then press **SELECT**.
 - You can end the intercom call and continue the outside call on the telephone base. Press **CANCEL**, **END**, **CELL 1** or **CELL 2** on the telephone base. The destination handset shows **Intercom ended**.

NOTES

- To cancel the call transfer and return to the external call before the intercom call is answered, press **CANCEL** on the telephone base.
- If the other device does not answer the intercom call within 100 seconds, or if the device is in use, on a call or out of range, the initiating device shows **No answer. Try again.** and returns to the outside call.

Push-to-talk (PTT)

You can directly broadcast messages to the speakerphone of any device. Press and hold **PUSH TO TALK** on a handset or **FLASH/PTT** on the telephone base to begin two-way communication.



- Only one device can talk at a time. While talking to another device, press and hold **PUSH TO TALK** on the handset or **FLASH/PTT** on the telephone base.
- You must release **PUSH TO TALK** on the handset or **FLASH/PTT** on the telephone base, so the other person can respond.
- Only one PTT session can be active at a time.
- While PTT is in use between two devices, other devices cannot use the intercom feature but can access the answering system.
- When you attempt to place a PTT call to another device which is accessing the answering system or on an intercom call or outside call, your device screen shows **Not available at this time**.

NOTE



- The PTT function is not available when **QUIET** mode is on.

Turn PTT on or off

Using a cordless handset:

1. Press **PUSH TO TALK** when the handset is not in use. The **PUSH TO TALK** menu displays.
2. Press **▼ CID** or **▲**  to highlight **PTT On/Off**, then press **SELECT**.
3. Press **▼ CID** or **▲**  to choose **On** or **Off**, then press **SELECT**.

Using the telephone base:

1. Press **FLASH/PTT** when the telephone base is not in use. The **PUSH TO TALK** menu displays.
2. Press **▼ CID** or **▲**  to highlight **PTT On/Off**, then press **SELECT**.
3. Press **▼ CID** or **▲**  to choose **On** or **Off**, then press **SELECT**.

NOTE

- The handset or the telephone base screen displays **No PTT call** when PTT is turned off.

PTT call to a single device

Using a cordless handset:

1. There are a few ways to begin a PTT call to a single device. When the handset is not in use:
 - If you have one handset, press and hold **PUSH TO TALK**.
 - If you have more than one handset:
 - ♦ Press **PUSH TO TALK** on the handset, then use the dialing keys to enter the destination device number.
 - OR-
 - ♦ Press **PUSH TO TALK** on the handset. Press **▼ CID** or **▲**  to highlight the destination device number, then press **SELECT** or **PUSH TO TALK**.

The handset shows **Connecting to HANDSET X...**

(**HANDSET** represents the handset name, **X** represents the destination handset number) or **Connecting to BASE 0...**

(**BASE** represents the base name) for a few seconds. When the connection is made, both your and the destination device screens display **Press and hold [PTT] to talk**.

2. Press and hold **PUSH TO TALK**. A chirp indicates your microphone is on. Speak towards the device. Your voice is broadcast to the destination device. While you are speaking, your handset shows **PTT To HANDSET X** or **PTT To BASE 0**.
3. Release **PUSH TO TALK** after speaking. Both devices beep once again and the screens show **Press and hold [PTT] to talk**, then you can press and hold **PUSH TO TALK** to continue speaking or the destination device can respond (see **Answer a PTT call**).
4. To end the PTT call, press **OFF/CANCEL** or **END**, or place the handset in the telephone base or charger. The handset shows **Push to talk ended**.

NOTE

- After **PUSH TO TALK** is released, the PTT call remains open for a short time. If no one presses **PUSH TO TALK** within 10 seconds, the PTT call ends automatically.

Using the telephone base:

1. There are a few ways to begin a PTT call to a single handset. When the telephone base is not in use:
 - If you have one handset, press and hold **FLASH/PTT**.
 - If you have more than one handset:
 - ♦ Press **FLASH/PTT**, then use the dialing keys to enter the destination handset number.
 - OR-
 - ♦ Press **▼ CID** or **▲**  to highlight the destination handset number, then press **SELECT** or **FLASH/PTT**.

The telephone base shows **Connecting to HANDSET X...**

(**HANDSET** represents the handset name, **X** represents the destination handset number) for a few seconds. When the connection is made, both the telephone base and destination handset display **Press and hold [PTT] to talk**.

2. Press and hold **FLASH/PTT**. A chirp indicates your microphone is on. Speak towards the telephone base. Your voice is broadcast to the destination handset. While you are speaking, your telephone base shows **PTT To HANDSET X**.

3. Release **FLASH/PTT** after speaking. Both devices beep once again and the screens show **Press and hold [PTT] to talk**, then you can press and hold **FLASH/PTT** to continue speaking or the destination device can respond (see **Answer a PTT call**).
4. To end the PTT call, press **CANCEL** or **END**. The telephone base shows **Push to talk Ended** for a few seconds.

NOTE

- After **FLASH/PTT** is released, the PTT call remains open for a short time. If no one presses **PTT/FLASH** within 10 seconds, the PTT call ends automatically.

PTT call to multiple devices

When there are multiple handsets registered to the phone system, PTT supports one-to-group calls. PTT supports a maximum of one-to-four calls when one to five handsets are registered, and a maximum of one-to-three calls when six or more handsets are registered. The first three or four registered handsets will be able to use this feature. Other handsets can only use PTT for one-to-one calls.

To call multiple devices:

Using a cordless handset:

1. You have two ways to call multiple devices. When the handset is not in use:
 - Press and hold **PUSH TO TALK** until the handset shows **Connecting to group...**
 - Press **PUSH TO TALK**. Press **▼ CID** or **▲**  to choose **Group**. Press **SELECT** or press **PUSH TO TALK** and your handset shows **Connecting to group...**

When the connection is made, both the caller and the destination parties hear a beep. The speakerphones on all other devices automatically activate.

2. You need to press and hold **PUSH TO TALK** when you want to speak. Speak towards the handset. Your voice is broadcast to all devices.
3. Release **PUSH TO TALK** after speaking.
4. Any extension can reply (see **Answer a PTT call**).

NOTE

- After **PUSH TO TALK** is released, the PTT call remains open for a short time. If no one presses **PUSH TO TALK** within 10 seconds, the PTT call ends automatically.

Using the telephone base:

1. You have two ways to call multiple devices. When the telephone base is not in use:
 - Press and hold **FLASH/PTT** until the screen shows **Connecting to group...**
 - Press **FLASH/PTT**. Press **▼ CID** or **▲**  to choose **Group**. Press **SELECT** or press **FLASH/PTT** and the telephone base shows **Connecting to group...**

When the connection is made, both the caller and the destination parties hear a beep. The speakerphones on all other devices automatically activate.

2. You need to press and hold **FLASH/PTT** when you want to speak. Speak towards the telephone base. Your voice is broadcast to all devices.
3. Release **FLASH/PTT** after speaking.
4. Any extension can reply (see **Answer a PTT call**).

NOTE

- After **FLASH/PTT** is released, the PTT call remains open for a short time. If no one presses **FLASH/PTT** within 10 seconds, the PTT call ends automatically.

Answer a PTT call

You can respond to a PTT call, as described below.

Using a cordless handset or the telephone base:

1. When your device receives a PTT call, it beeps and shows **Press and hold [PTT] to talk**.
2. When the other party is speaking, your speakerphone light is on, and your device shows:
 - **PTT From HANDSET X To devices: X** (the first **X** represents the initiating handset number, and the second **X** represents your handset number; a maximum of four handset numbers appear).

-OR-

- **PTT From BASE 0 To devices: X** (the **X** represents your handset number; a maximum of four handset numbers appear).
3. When your speakerphone light is off (the screen shows **Press and hold [PTT] to talk**), **press and hold PUSH TO TALK** on your handset or **FLASH/PTT** on your telephone base. You will hear a chirp. Speak towards the device.
 - While you are speaking, your device shows **PTT To BASE 0** or **PTT To HANDSET X** (**X** represents the destination handset number), or **PTT To devices: X** (**X** represents the handset numbers of one or more destination handsets; a maximum of four handset numbers appear).
 - Your voice is broadcast to all destination devices.

After speaking, release **PUSH TO TALK** on your handset or **FLASH/PTT** on your telephone base. Your device will beep. After the beep, if your speakerphone light is off, you can **press and hold PUSH TO TALK** on your handset or **FLASH/PTT** on your telephone base to continue speaking, or the destination device can respond.

Change a one-to-one PTT call to an intercom call

You can convert a one-to-one PTT session to an intercom call.

Using a cordless handset or the telephone base:

1. When your device shows **Press and hold [PTT] to talk**, press **INTCOM**. The screen shows **Switch to Intercom?**.
2. Press **SELECT**. Your device displays **Calling BASE 0** or **Calling HANDSET X**. The destination device briefly shows **Push to talk Ended** and then **HANDSET X is calling** or **BASE 0 is calling**. The destination device rings.
3. Press **HOME/FLASH** or any dialing keys (**0-9**, or **TONEX**) on the destination handset, or press **HOME** or any dialing keys (**0-9**, or **TONEX**) on the telephone base to answer the intercom call. Both devices now show **Intercom**.
4. To end the intercom call, press **OFF/CANCEL** on your handset or place the handset in the telephone base or charger, or press **END** on the handset or telephone base. Both screens show **Intercom ended**.

Answer an incoming call during a PTT call

When you receive an outside call during PTT, there is an alert tone.

Using a cordless handset or the telephone base:

- During a one-to-one PTT call, press **HOME/FLASH, CELL 1** or **CELL 2** on the initiating or destination handset, or press **HOME, CELL 1** or **CELL 2** on the telephone base. The PTT call ends automatically and the outside call is answered.
- During a one-to-group PTT call, press **HOME/FLASH, CELL 1** or **CELL 2** on the initiating handset, or press **HOME, CELL 1** or **CELL 2** on the telephone base. The PTT call ends automatically and the outside call is answered.
- During a one-to-group PTT call, press **HOME/FLASH, CELL 1** or **CELL 2** on any one of the destination handsets, or press **HOME, CELL 1** or **CELL 2** on the telephone base. That device answers the outside call. The PTT call continues for the rest of the PTT participants.
- To leave the PTT call without answering the incoming call, press **OFF/CANCEL** on your handset or **CANCEL** on your telephone base. The telephone continues to ring.

Make an outgoing call during a PTT call

Using a cordless handset or the telephone base:

- During a one-to-one PTT call, press **HOME/FLASH** on your handset or press **HOME** on the telephone base to get a dial tone. The PTT call ends automatically.
- During a one-to-group PTT call, press **HOME/FLASH** on the initiating handset or press **HOME** on the telephone base. The PTT call ends automatically and you get a dial tone.
- During a one-to-group PTT call, press **HOME/FLASH** on any one of the destination handsets or press **HOME** on the telephone base. That device gets a dial tone. The PTT call continues for the rest of the PTT participants.

End or leave a PTT call

Using a cordless handset or the telephone base:

For one-to-one PTT calls, both initiating and destination devices can end the PTT call. For PTT calls to multiple devices, the initiating device can end the PTT call. If any one of the destination devices leaves the PTT call, the call continues until all participants or the initiator hangs up.

Press **OFF/CANCEL** or **END** on the handset, or press **CANCEL** or **END** on the telephone base. The screen shows **Push to talk Ended**.

-OR-

Place the handset in the telephone base or charger, then the handset returns to idle mode.

NOTE

- After **PUSH TO TALK** on the handset or **FLASH/PTT** on the telephone base is released, the PTT call remains open for a short time. If no one presses **PUSH TO TALK** on the handset or **FLASH/PTT** on the telephone base within 10 seconds, the PTT call ends automatically.

Phonebook

The home phonebook directory stores up to 200 entries with up to 30 digits for each phone number and 15 characters for each name. Each of the downloaded phonebooks stores up to 1,500 entries with up to 30 digits for each phone number and 15 characters for each name.

- Phonebook entries are stored at the telephone base and shared by all system handsets. Any changes made on one device apply to all.
- Only one device can review the phonebook at a time. If another device tries to enter the phonebook, its screen shows **Not available at this time**.
- When you try to save a number already stored in the phonebook, the screen shows **Number already saved**.
- Phonebook entries can also be saved to the allow list or block list. See **Allow list** and **Block list**.
- When Smart call blocker is on, calls with numbers saved in the phonebook will get through and ring on your telephone. If a number saved in the phonebook is also saved in the block list, calls from this number will be blocked.

Add a phonebook directory entry

Using a cordless handset:

1. Press **MENU** on the handset in idle mode to enter the main menu.
2. Press **▼ CID** or **▲** to scroll to **Phonebook**, then press **SELECT**.
3. Press **OPTION** to choose **Home**.
4. Press **SELECT** to choose **Add contact**. The screen displays **Enter number**.
5. Use the dialing keys to enter a telephone number.
 - Press **▼ CID** or **▲** to move the cursor to the left or right.
 - Press **MUTE/DELETE** or **BACKSP** to erase a digit.
 - **Press and hold MUTE/DELETE** to erase all digits.
 - **Press and hold REDIAL/PAUSE** to insert a dialing pause (a **p** appears).

-OR-

Copy a number from the redial list. Press **REDIAL/PAUSE** and then **▼ CID**, **▲** or **REDIAL/PAUSE** repeatedly to locate the number. Press **INSERT** to copy the displayed number.

6. Press **NEXT**.
7. Press **▼ CID** or **▲** to highlight one of the following types:
 - Home
 - Cell
 - Work
 - Other
8. Press **NEXT**. The screen displays **Enter name**.

9. Use the dialing keys to enter a name (up to 15 characters).
 - Press **▼ CID** or **▲** to move the cursor to the left or right.
 - Press **0** to add a space.
 - Press **MUTE/DELETE** or **BACKSP** to erase a character.
 - **Press and hold MUTE/DELETE** to erase all characters.
 - Press **a>A** to change the next letter to upper or lower case.
10. Press **SAVE** to confirm. You hear a confirmation tone.

Using the telephone base:

1. Press **MENU** on the telephone base in idle mode to enter the main menu.
2. Press **▼ CID** or **▲** to scroll to **Phonebook**, then press **SELECT**.
3. Press **OPTION** to choose **Home**.
4. Press **SELECT** to choose **Add contact**. The screen displays **ENTER NUMBER**.
5. Use the dialing keys to enter a telephone number.
 - Press **▼ CID** or **▲** to move the cursor to the left or right.
 - Press **DELETE** or **BACKSP** to erase a digit.
 - **Press and hold DELETE** to erase all digits.
 - **Press and hold REDIAL/PAUSE** to insert a dialing pause (a **p** appears).

-OR-

Copy a number from the redial list. Press **REDIAL/PAUSE** and then **▼ CID**, **▲** or **REDIAL/PAUSE** repeatedly to locate the number. Press **INSERT** to copy the displayed number.

6. Press **NEXT**.
7. Press **▼ CID** or **▲** to highlight one of the following types:
 - Home
 - Cell
 - Work
 - Other
8. Press **NEXT**. The screen displays **ENTER NAME**.
9. Use the dialing keys to enter a name (up to 15 characters).
 - Press **▼ CID** or **▲** to move the cursor to the left or right.
 - Press **0** to add a space.
 - Press **DELETE** or **BACKSP** to erase a character.
 - **Press and hold DELETE** to erase all characters.
 - Press **a>A** to change the next letter to upper or lower case.
10. Press **SAVE** to confirm. You hear a confirmation tone.

Add a predialed telephone number to the phonebook

You can save a predialed telephone number to the phonebook.

Using a cordless handset:

1. Enter the telephone number when in idle mode, then press **SAVE** to move on to edit the number and then press **NEXT**.
2. Press **▼ CID** or **▲** to highlight one of the following types:
 - Home
 - Cell
 - Work
 - Other
3. Press **NEXT**. The screen displays **Enter name**.
4. Use the dialing keys to edit the name.
 - Press **▼ CID** or **▲** to move the cursor to the left or right.
 - Press **MUTE/DELETE** or **BACKSP** to erase a character.
 - **Press and hold MUTE/DELETE** to erase all characters.
5. Press **SAVE** to confirm. You hear a confirmation tone.

Using the telephone base:

1. Enter the telephone number when in idle mode, then press **SAVE** to move on to edit the number and then press **NEXT**.
2. Press **▼ CID** or **▲** to highlight one of the following types:
 - Home
 - Cell
 - Work
 - Other
3. Press **NEXT**. The screen displays **ENTER NAME**.
4. Use the dialing keys to edit the name.
 - Press **▼ CID** or **▲** to move the cursor to the left or right.
 - Press **DELETE** or **BACKSP** to erase a character.
 - **Press and hold DELETE** to erase all characters.
5. Press **SAVE** to confirm. You hear a confirmation tone.

Review a phonebook entry

Using the handset:

1. Press **▲** on the handset when in idle mode.
2. Press **▼ CID** or **▲** to highlight a phonebook entry, then press **REVIEW**.
3. Press **▼ CID** or **▲** to browse.

-OR-

1. Press **MENU** when in idle mode.
2. Press **▼ CID** or **▲** to scroll to **Phonebook** then press **SELECT**.
3. Press **▼ CID** or **▲** to highlight a directory, then press **REVIEW**.
4. Press **▼ CID** or **▲** to browse.

-OR-

1. Press **OPTION** while on a call.
2. Press **▼ CID** or **▲** to scroll to **Phonebook** then press **SELECT**.
3. Press **▼ CID** or **▲** to highlight a directory, then press **REVIEW**.
4. Press **▼ CID** or **▲** to browse.

Using the telephone base:

1. Press **▲** on the telephone base when in idle mode.
2. Press **▼ CID** or **▲** to highlight a phonebook entry, then press **REVIEW**.
3. Press **▼ CID** or **▲** to browse.

-OR-

1. Press **MENU** when in idle mode.
2. Press **▼ CID** or **▲** to scroll to **Phonebook** then press **SELECT**.
3. Press **▼ CID** or **▲** to highlight a directory, then press **REVIEW**.
4. Press **▼ CID** or **▲** to browse.

-OR-

1. Press **OPTION** while on a call.
2. Press **▼ CID** or **▲** to scroll to **Phonebook** then press **SELECT**.
3. Press **▼ CID** or **▲** to highlight a directory, then press **REVIEW**.
4. Press **▼ CID** or **▲** to browse.

NOTE

- When the desired entry displays, press # (pound key) on the handset or telephone base repeatedly to show different dialing options.

3-character alphabetical search

You can use the enhanced 3-character search to find your contacts quickly and efficiently.

1. Follow the steps in **Review a phonebook entry** above to enter the phonebook.
2. When an entry appears, use the dialing keys to enter the letters associated with the name (see page 89). You can enter up to 3 letters for the search. The letters will show at the top left hand corner of the screen. After you have entered one to three letters, the system starts searching in the phonebook. If there is no name matching the letter(s) entered, the next closest match in alphabetical order appears. If necessary, press **▼** or **▲** on the handset or telephone base to browse.

NOTE

- The cursor automatically moves to the next position 2 seconds after you enter a letter. If you do not enter another letter in the coming 2 seconds, the system starts searching in the phonebook.

Dial a phonebook entry

You can dial a phonebook entry on any line.

To dial a phonebook entry:

1. Search for the desired entry in the phonebook (see **Review a phonebook entry** and **3-character alphabetical search**).
2. When the desired entry appears, press # (pound key) repeatedly on the handset or telephone base to show different dialing options.
3. When the displayed number is in the correct format, press **HOME/FLASH** or **▲** on the handset, or press **HOME** on the telephone base to use the home line. Press **CELL 1** or **CELL 2** on the handset or telephone base to use the cell line.

Edit a phonebook entry

You can edit any phonebook entry. However, be aware that if you download a phonebook from a cell phone again, the phonebook is erased and replaced with the current cell phone directory. If you have edited the downloaded entries on the **IS8151/IS8251**, those changes are lost. To avoid losing changes made to the downloaded phonebook, we suggest that you edit numbers in your cell phone, then download the phonebook.

Using a cordless handset:

1. Search for the desired entry in the phonebook (see **Review a phonebook entry** and **3-character alphabetical search**).
2. When a phonebook entry displays, press **EDIT**. The screen shows **Edit number** along with the phone number to be edited.
3. Use the dialing keys to edit the number.
 - Press **▼ CID** or **▲** to move the cursor to the left or right.
 - Press **MUTE/DELETE** or **BACKSP** to erase a digit.
 - **Press and hold MUTE/DELETE** to erase all digits.
 - **Press and hold REDIAL/PAUSE** to insert a dialing pause (a **p** appears).
4. Press **NEXT**.

5. Press **▼ CID** or **▲** to highlight one of the following types:
 - Home
 - Cell
 - Work
 - Other
6. Press **NEXT**. The screen displays **Enter name**.
7. Use the dialing keys to edit the name.
 - Press **▼ CID** or **▲** to move the cursor to the left or right.
 - Press **0** to add a space.
 - Press **MUTE/DELETE** or **BACKSP** to erase a character.
 - **Press and hold MUTE/DELETE** to erase all characters.
8. Press **SAVE** to confirm. You hear a confirmation tone.

Using the telephone base:

1. Search for the desired entry in the phonebook (see **Review a phonebook entry** and **3-character alphabetical search**).
2. When a phonebook entry displays, press **EDIT**. The screen shows **EDIT NUMBER** along with the phone number to be edited.
3. Use the dialing keys to edit the number.
 - Press **▼ CID** or **▲** to move the cursor to the left or right.
 - Press **DELETE** or **BACKSP** to erase a digit.
 - **Press and hold DELETE** to erase all digits.
 - **Press and hold REDIAL/PAUSE** to insert a dialing pause (a **p** appears).
4. Press **NEXT**.
5. Press **▼ CID** or **▲** to highlight one of the following types:
 - Home
 - Cell
 - Work
 - Other
6. Press **NEXT**. The screen displays **EDIT NAME**.
7. Use the dialing keys to edit the name.
 - Press **▼ CID** or **▲** to move the cursor to the left or right.
 - Press **0** to add a space.
 - Press **DELETE** or **BACKSP** to erase a character.
 - **Press and hold DELETE** to erase all characters.
8. Press **SAVE** to confirm. You hear a confirmation tone.

Edit the type of a phonebook entry

If you only want to edit the type of a phonebook entry:

1. Search for the desired entry in the phonebook (see **Review a phonebook entry** and **3-character alphabetical search**).
2. When a phonebook entry displays, press **LABEL**. Enter the corresponding shortcut keys shown on the screen.
-OR-
Press **CLEAR** to erase the assigned label.

Delete a phonebook entry

To delete an entry:

1. Search for the desired entry in the phonebook (see **Review a phonebook entry** and **3-character alphabetical search**).
2. When the desired entry appears, press **MUTE/DELETE** on the handset or **DELETE** on the telephone base. The screen displays **Delete contact?** and the name of the entry. Press **YES** to confirm.
3. The screen displays **Contact deleted** and then the next alphabetical entry in the phonebook. You hear a confirmation tone.

NOTE

- Once a phonebook entry is deleted, it cannot be retrieved.

Remove a downloaded cell phone directory

Using a cordless handset or telephone base:

1. Search for the desired downloaded phonebook in the phonebook menu (see **Review a phonebook entry** and **3-character alphabetical search**).
2. When the desired downloaded phonebook is chosen, press **OPTION**, then press **▼ CID** or **▲** on the handset or telephone base to highlight **Remove dir.**
3. Press **SELECT**. The screen displays **Directory Cell Phone X will be erased (Cell Phone X represents the device name of your cell phone)**.
4. Press **YES** to confirm. You hear a confirmation tone.

Caller ID

If you subscribe to caller ID service, information about each caller appears after the first or second ring. If you answer a call before the caller information appears on the screen, it will not be saved in the caller ID log.

The caller ID log stores up to 30 entries. Each entry has up to 24 digits for the phone number and 15 characters for the name.

If the telephone number has more than 15 digits, only the last 15 digits appear.

If the name has more than 15 characters, only the first 15 characters are shown and saved in the caller ID log.

Entries appear in reverse chronological order. When the caller ID log is full, the oldest entry is deleted to make room for new incoming call information.

Caller ID log entries are shared by all system handsets (for multiple handset models only). Any deletions made on one handset are reflected on all other handsets.

NOTE

- This product can provide information only if both you and the caller are in areas offering caller ID service and if both telephone service providers use compatible equipment. The time and date are sent by your telephone service provider along with the call information.

Review a caller ID log entry

Review the caller ID log to find out who called, to return the call, or to copy the caller's name and number into your phonebook. **Caller ID log empty** appears if there are no records in the caller ID log.

1. When the handset or the telephone base is in idle mode, press **▼ CID** on the handset or telephone base to review the caller ID log in reverse chronological order starting with the most recent call.
-OR-
Review the caller ID log by pressing **MENU**. Press **▼ CID** or **▲** on the handset or telephone base to scroll to **Caller ID log**, then press **SELECT** twice to select **Review**.
2. Press **▼ CID** or **▲** on the handset or telephone base to scroll through the list.

NOTE

- Only one handset or the telephone base can review the caller ID log at a time. If another device tries to enter the phonebook or caller ID log, it shows **Not available at this time**.

Memory match

When the incoming telephone number matches the last seven digits of a telephone number in your phonebook, the screen displays the stored name of the phonebook entry.

For example, if Linda Jones calls, her name appears as **Linda** if this is how you entered it into your phonebook.

NOTE

- The number shown in the caller ID log is in the format sent by the telephone service provider. It usually delivers 10-digit telephone numbers (area code plus phone number). If the last seven digits of the incoming telephone number does not match a number in your phonebook, the name appears as it is delivered by the telephone service provider.

Missed call indicator

When there are calls that have not been reviewed in the caller ID log, the handset displays **XX missed calls**.

Each time you review a caller ID log entry marked **NEW**, the number of missed calls decreases by one.

When you have reviewed all the missed calls, the missed call indicator no longer displays.

If you do not want to review the missed calls one by one, but still want to keep them in the caller ID log, you can press and hold **OFF/CANCEL** on the handset for four seconds when the handset is idle, or press and hold **CANCEL** on the telephone base for four seconds when the telephone base is idle. You will hear a confirmation tone. All the entries in the caller ID log become old (reviewed already), and the missed calls message goes away.

View dialing options

Although the caller ID log entries received have 10 digits (the area code plus the seven-digit number), in some areas, you may dial only the seven digits, or a 1 plus the seven digits, or a 1 plus the area code plus the seven digits. You can change the number of digits that you dial from or store to the phonebook.

While reviewing the caller ID log, press **#** (pound key) repeatedly to show different dialing options for local and long distance numbers before dialing or saving the telephone number in the phonebook.

Press **1** repeatedly if you need to add or remove 1 in front of the telephone number before dialing or saving it in the phonebook.

→	Press # →	1-800-595-9511
→	Press # →	595-9511
→	Press # →	1-595-9511
→	Press # →	800-595-9511
-OR-		
→	Press 1 →	1-800-595-9511
→	Press 1 →	800-595-9511

NOTE

- If you have programmed the home area code, only the last seven digits of the incoming phone numbers from that area code will be displayed while reviewing the caller ID log. Press **#** repeatedly to display all possible dialing options.

Dial a caller ID log entry

1. When in the caller ID log, press **▼ CID** or **▲** on the handset or telephone base to browse.
2. Press **HOME/FLASH** or **☎** on the handset, or **HOME** on the telephone base to dial the displayed entry using the home line.
-OR-
Press **CELL 1** or **CELL 2** on the handset or telephone base to dial the display entry using the cell line.

Save a caller ID log entry to the phonebook

Caller ID log entries can only be saved to the Home directory.

Using a cordless handset:

1. Select a desired entry in the caller ID log (see **Review a caller ID log entry**).
2. When the desired entry appears, press **SAVE**.
3. Press **SELECT** to select **Phonebook**. The screen displays **Edit number**.
4. Use the dialing keys to edit the number.
 - Press **▼ CID** or **▲** to move the cursor to the left or right.
 - Press **MUTE/DELETE** or **BACKSP** to erase a digit.
 - Press and hold **MUTE/DELETE** to erase all digits.
 - Press and hold **REDIAL/PAUSE** to insert a dialing pause (a **p** appears).
5. Press **NEXT**.
6. Press **▼ CID** or **▲** to highlight one of the following types:
 - Home
 - Cell
 - Work
 - Other
7. Press **NEXT**. The screen displays **Edit name**.
8. Use the dialing keys to edit the name.
 - Press **▼ CID** or **▲** to move the cursor to the left or right.
 - Press **0** to add a space.
 - Press **MUTE/DELETE** or **BACKSP** to erase a character.
 - Press and hold **MUTE/DELETE** to erase all characters.
 - Press **#** (pound key) to move the last word to the front. For example, **Johnson Charlie** becomes **Charlie Johnson** when you press **#** (pound key).
9. Press **SAVE** to confirm. You hear a confirmation tone.

Using the telephone base:

1. Select a desired entry in the caller ID log (see **Review the caller ID log**).
2. When the desired entry appears, press **SAVE**.
3. Press **SELECT** to select **Phonebook**. The telephone base displays **EDIT NUMBER**.
4. Use the dialing keys to edit the number.
 - Press **▼ CID** or **▲** to move the cursor to the left or right.
 - Press **DELETE** or **BACKSP** to erase a digit.
 - Press and hold **DELETE** to erase all digits.

- Press and hold **REDIAL/PAUSE** to insert a dialing pause (a **p** appears).
5. Press **NEXT**.
 6. Press **▼ CID** or **▲** to highlight one of the following types:
 - Home
 - Cell
 - Work
 - Other
 7. Press **NEXT**. The telephone base displays **EDIT NAME**.
 8. Use the dialing keys to edit the name.
 - Press **▼ CID** or **▲** to move the cursor to the left or right.
 - Press **0** to add a space.
 - Press **DELETE** or **BACKSP** to erase a character.
 - Press and hold **DELETE** to erase all characters.
 - Press **#** (pound key) to move the last word to the front. For example, **Johnson Charlie** becomes **Charlie Johnson** when you press **#** (pound key).
 9. Press **SAVE** to confirm. You hear a confirmation tone.

NOTES

- If the caller's name you received from the telephone service provider is all in capital letters, the first letter of every word remains a capital letter, while other letters become lower case. However, the next letter after the prefix "Mac", "Mc", "D", "C" or "O", is kept as a capital letter. For example, the "D" in "MacDonald" is kept as a capital letter. Another exception is that "VAN DER" will be changed to "Van der".
- If the telephone number from the caller ID information has already been saved in the phonebook under a different name, the new name will overwrite the old one.
- If you save a block number in the caller ID log to the phonebook, the original name from the caller ID information will be saved.

Save a caller ID log entry to the allow list

Using a cordless handset:

1. Select a desired entry in the caller ID log (see **Review a caller ID log entry**).
2. When the desired entry appears, press **SAVE**.
3. Press **▼ CID** or **▲** to highlight **Allow list**, and then press **SELECT**. The screen displays **Edit number**.
4. Use the dialing keys to edit the number.
 - Press **▼ CID** or **▲** to move the cursor to the left or right.
 - Press **MUTE/DELETE** or **BACKSP** to erase a digit.
 - Press and hold **MUTE/DELETE** to erase all digits.
 - Press and hold **REDIAL/PAUSE** to insert a dialing pause (a **p** appears).
5. Press **NEXT**. The screen displays **Edit name**.
6. Use the dialing keys to edit the name.
 - Press **▼ CID** or **▲** to move the cursor to the left or right.
 - Press **0** to add a space.
 - Press **MUTE/DELETE** or **BACKSP** to erase a character.
 - Press and hold **MUTE/DELETE** to erase all characters.
 - Press **#** (pound key) to move the last word to the front. For example, **Johnson Charlie** becomes **Charlie Johnson** when you press **#** (pound key).
7. Press **SAVE** to confirm. The screen shows **Saved to allow list**.

Using the telephone base:

1. Select a desired entry in the caller ID log (see **Review a caller ID log entry**).
2. When the desired entry appears, press **SAVE**.
3. Press **▼ CID** or **▲** to highlight **Allow list**, and then press **SELECT**. The screen displays **EDIT NUMBER**.
4. Use the dialing keys to edit the number.
 - Press **▼ CID** or **▲** to move the cursor to the left or right.
 - Press **DELETE** or **BACKSP** to erase a digit.
 - Press and hold **DELETE** to erase all digits.
 - Press and hold **REDIAL/PAUSE** to insert a dialing pause (a **p** appears).
5. Press **NEXT**. The telephone base displays **EDIT NAME**.
6. Use the dialing keys to edit the name.
 - Press **▼ CID** or **▲** to move the cursor to the left or right.
 - Press **0** to add a space.
 - Press **DELETE** or **BACKSP** to erase a character.
 - Press and hold **DELETE** to erase all characters.
 - Press **#** (pound key) to move the last word to the front. For example, **Johnson Charlie** becomes **Charlie Johnson** when you press **#** (pound key).
7. Press **SAVE** to confirm. The telephone base shows **Saved to allow list**.

Save a caller ID log entry to the block list

Using a cordless handset:

1. Select a desired entry in the caller ID log (see **Review a caller ID log entry**).
2. When the desired entry appears, press **SAVE**.
3. Press **▼ CID** or **▲** to highlight **Block list**, and then press **SELECT**. The screen displays **Edit number**.
4. Use the dialing keys to edit the number.
 - Press **▼ CID** or **▲** to move the cursor to the left or right.
 - Press **MUTE/DELETE** or **BACKSP** to erase a digit.
 - Press and hold **MUTE/DELETE** to erase all digits.
 - Press and hold **REDIAL/PAUSE** to insert a dialing pause (a **p** appears).
5. Press **NEXT**. The screen displays **Edit name**.
6. Use the dialing keys to edit the name.
 - Press **▼ CID** or **▲** to move the cursor to the left or right.
 - Press **0** to add a space.
 - Press **MUTE/DELETE** or **BACKSP** to erase a character.
 - Press and hold **MUTE/DELETE** to erase all characters.
 - Press **#** (pound key) to move the last word to the front. For example, **Johnson Charlie** becomes **Charlie Johnson** when you press **#** (pound key).
7. Press **SAVE** to confirm. The screen shows **Saved to block list**.

Using the telephone base:

1. Select a desired entry in the caller ID log (see **Review a caller ID log entry**).
2. When the desired entry appears, press **SAVE**.
3. Press **▼ CID** or **▲** to highlight **Block list**, and then press **SELECT**. The screen displays **EDIT NUMBER**.
4. Use the dialing keys to edit the number.
 - Press **▼ CID** or **▲** to move the cursor to the left or right.
 - Press **DELETE** or **BACKSP** to erase a digit.
 - Press and hold **DELETE** to erase all digits.
 - Press and hold **REDIAL/PAUSE** to insert a dialing pause (a **p** appears).
5. Press **NEXT**. The telephone base displays **EDIT NAME**.
6. Use the dialing keys to edit the name.
 - Press **▼ CID** or **▲** to move the cursor to the left or right.
 - Press **0** to add a space.
 - Press **DELETE** or **BACKSP** to erase a character.
 - Press and hold **DELETE** to erase all characters.
 - Press **#** (pound key) to move the last word to the front. For example, **Johnson Charlie** becomes **Charlie Johnson** when you press **#** (pound key).
7. Press **SAVE** to confirm. The telephone base shows **Saved to block list**.

Save a caller ID log entry to the star name list

Using a cordless handset or the telephone base:

1. Select a desired entry in the caller ID log (see **Review a caller ID log entry**).
2. When the desired entry appears, press **SAVE**.
3. Press **▼ CID** or **▲** to highlight **Star name list**, and then press **SELECT**. The screen displays **Star this name?** and then the caller's name.
4. Press **SELECT** to confirm. The screen shows **Saved to star name list**.

Delete the caller ID log entries

To delete an entry:

Press **MUTE/DELETE** on the handset or **DELETE** on the telephone base to delete the shown entry.

To delete all entries:

1. Press **MENU** when in idle mode.
2. Press **▼ CID** or **▲** on the handset or press telephone base to scroll to **Caller ID log**, then press **SELECT**.
3. Press **▼ CID** or **▲** on the handset or telephone base to scroll to **Del all calls**, then press **SELECT**.
4. When the screen shows **Delete all calls?**, press **YES** to confirm. There is a confirmation tone and the screen returns to the previous menu.

About Smart call blocker

If you have subscribed to caller ID service, then you can use Smart call blocker to screen robocalls, telemarketing calls and unwanted calls for you, while allowing welcome calls to get through. †

† The screening feature of Smart call blocker is applicable to home calls only. All incoming cell calls will get through and ring.

You can set up your lists of welcome callers and unwelcome callers. Smart call blocker allows calls from your welcome callers to get through, and it blocks calls from your unwelcome callers.

For other unknown home calls, you can allow these calls, block these calls, or forward these calls to the answering system.

With some easy configurations, you can set to only filter robocalls on the home line by asking the callers to press the pound key (#) before the calls are put through to you.

You can also set Smart call blocker to screen incoming home calls by asking the callers to record their names and press the pound key (#). After your caller completes the request, your telephone rings and announces the caller's name. You can then choose to block or answer the call, or you can forward the call to the answering system. If the caller does not respond or record his/her name, the call is blocked from ringing through. When you add your welcome callers to your allow list, they will bypass all screening and ring directly to your handsets.

NOTES

- Smart call blocker is on, once you install your telephone. It allows all incoming calls to get through and ring by default. You can change the Smart call blocker settings to screen incoming home calls. For more details, see **Set profile**.
- With call screening active, Smart call blocker screens and filters incoming home calls from numbers or names that are not yet saved in your phonebook, allow list, block list, or star name list. You can easily add incoming phone numbers to your allow list and block list. This allows you to build up your lists of allowed and blocked numbers, and Smart call blocker will know how to deal with these calls when they come in again.
- To turn off Smart call blocker, see **Set Smart call blocker on/off**.

Call categories

Calls are classified into four categories:

Welcome calls

Welcome calls are calls with telephone numbers saved in your allow list or phonebook, and not in your block list. Welcome calls also include calls with caller names saved in your star name list.

NOTES

- All incoming calls on your cell lines will get through and ring, unless the caller's numbers are saved in your block list. If you want to block a cell call, add the number to the block list. See **Block list**.
- There are many organizations like schools, medical offices, and pharmacies that use robocalls to communicate important information to you. Robocall uses an autodialer to deliver pre-recorded messages. By entering the name of the organizations into the star name list, it ensures these calls will ring through when you only know the caller names but not their numbers.

Unwelcome calls

Unwelcome calls are calls with telephone numbers saved in your block list, and you want to block their calls.

Calls without numbers (for home calls only)

Calls without numbers are calls that are "out of area" or with numbers set to "Private".

Uncategorized calls (for home calls only)

Uncategorized calls include calls with absent caller ID number, calls with numbers that are not in your phonebook, allow list, or block list, or calls with caller ID names that are not in your star name list.

NOTE

- The allow list stores up to 200 entries, the block list stores up to 1,000 entries, and the star name list stores up to 10 names.

Call handling

- Smart call blocker is set to on, and to allow all incoming calls by default. When Smart call blocker is on, the first ring of all incoming calls will be muted.
- If your phonebook, allow list, star name list and block list are empty when Smart call blocker is on, and you have set to screen calls, the telephone will screen all incoming home calls and asks callers to announce their names or press the pound key (#).
- If Smart call blocker is off, all incoming calls ring, including numbers saved in the block list.
- If **QUIET** mode is on, and Smart call blocker is on and in screening mode, all screened home calls will be sent to the answering system after screening.

Smart call blocker handles calls in the following ways:

Call category	Call control
Welcome calls <ul style="list-style-type: none"> • Numbers saved in allow list. • Numbers saved in phonebook. • Numbers not found in block list. • Caller ID names saved in star name list. 	Allow <ul style="list-style-type: none"> • The telephone rings when there is an incoming call with number saved in your allow list or phonebook, but not in your block list. Robocalls with caller names saved in your star name list will also ring. • All incoming calls on your cell line will get through and ring.
Unwelcome calls <ul style="list-style-type: none"> • Numbers saved in block list. 	Block <p>The telephone does not ring when there is an incoming call with number saved in your block list, and the call will be rejected.</p>

Call category	Call control
Unknown calls (for home calls only) <ul style="list-style-type: none"> • Calls without numbers <ul style="list-style-type: none"> - Numbers that are "out of area" or set to "Private". • Uncategorized calls <ul style="list-style-type: none"> - With absent caller ID number. - Numbers not found in phonebook. - Numbers not found in allow list. - Numbers not found in block list. - With caller ID names not found in star name list 	<p>You can select one of the following five profile options for handling all unknown home calls.</p> <p>Screen unknown</p> <p>The telephone plays the screening announcement, and then ask the caller to say his/her name before the call rings on your telephone. You can then answer the call, and hear the caller's name announced. You can decide whether to accept or reject the call, or to forward the call to the answering system.</p> <p>Screen robot</p> <p>The telephone plays the screening announcement, and then ask the caller to press the pound key (#) before the call rings on your telephone. You can then answer the call.</p> <p>Allow unknown (default settings)</p> <p>The telephone allows these calls to get through and ring. The caller's number, even if it is available, will not be saved to the allow list.</p> <p>Unknown to answering system</p> <p>The telephone forwards these calls to the answering system without ringing.</p> <p>Block unknown</p> <p>The telephone rejects these calls with block announcement without ringing. The caller's number, even if it's available, will not be saved to the block list.</p>

NOTE

- You can set to screen, allow, or block all unknown home calls without numbers, or unknown home calls with numbers not saved in your phonebook, allow list or star name list. You can also send these calls to the answering system. **Allow unknown** is the default profile setting. To change the setting, see **Set profile**.

Set Smart call blocker on/off

The Smart call blocker feature is set to on by default.

Using a cordless handset or the telephone base:

1. Press **CALL BLOCK** on the handset or telephone base to enter the call block menu when the telephone is not in use.

- OR -

1. Press **MENU** on the handset or telephone base in idle mode to enter the main menu. Then, press **▼ CID** or **▲** to scroll to **Smart call blk.** Press **SELECT**.
2. Press **SELECT** again to choose **SCB On/Off**.
3. Press **▼ CID** or **▲** to scroll to **On** or **Off**, and then press **SELECT**.

NOTE

- If you set **SCB On/Off** to **Off**, all settings under **Set profile** (see below) will be invalid.

Set profile

There are five profile setting options, which allows you to quickly set up Smart call blocker.

Using a cordless handset or the telephone base:

1. Press **CALL BLOCK** on the handset or telephone base to enter the call block menu when the telephone is not in use.

- OR -

1. Press **MENU** on the handset or telephone base in idle mode to enter the main menu. Then, press **▼ CID** or **▲** to scroll to **Smart call blk.** Press **SELECT**.
2. Press **▼ CID** or **▲** to scroll to **Set profile**, and then press **SELECT**.
3. Press **▼ CID** or **▲** to select one of the following options, then press **SELECT**.

- **Screen unknown** - screen any home calls without numbers or with numbers not saved in the phonebook, allow list, or star name list.
 - This profile setting sets the telephone to screen all unknown home calls and asks the callers to say their names before putting the calls through to you. See **Screen unknown home calls**.
- **Screen robot** - screen robocalls.
 - This profile setting sets the telephone to screen all unknown home calls and asks the callers to press the pound key (#) before putting the calls through to you. See **Screen robocalls**.
- **Allow unknown** (default setting) - allow all unknown home calls to ring, except calls with numbers saved in the block list.
 - This profile setting sets the telephone to allow all unknown home calls to get through and ring. Calls with numbers saved in the block list will be rejected.
- **UnknownToAns.S** - forward all unknown home calls to the answering system.
 - This profile setting sets the telephone to forward all unknown home calls to the answering system.
- **Block unknown** - block all unknown home calls.
 - This profile setting sets the telephone to block all unknown home calls.

After selecting a profile setting, make sure you have not turned off Smart call blocker. Refer to the **Set Smart call blocker on/off** section to it on.

NOTES

- If you set **SCB On/Off** to **Off**, selected setting under **Set profile** will be invalid, and all incoming home and cell calls will ring, including calls with numbers in your block list.
- There may be robocalls that you do not want to miss. For example, robocalls with announcements or notices from schools or pharmacies. You can set up your star name list with these caller names to allow their calls to get through to you. See **Star name list** section.

Block list

Add numbers that you want to prevent their calls from ringing through. The block list stores up to 1,000 entries.

NOTE

- Home or cell calls with numbers that have been added to your block list will be blocked.

Add a block list entry:

Using a cordless handset or the telephone base:

1. Press **CALL BLOCK** on the handset or telephone base to enter the call block menu when the telephone is not in use.

- OR -

1. Press **MENU** on the handset or telephone base in idle mode to enter the main menu. Then, press **▼ CID** or **▲** to scroll to **Smart call blk.** Press **SELECT**.
2. Press **▼ CID** or **▲** to highlight **Block list**, and then press **SELECT**.
3. Press **▼ CID** or **▲** to highlight **Add new entry**, and then press **SELECT**.
4. When the screen displays **Enter number**, use the dialing keys to enter the number.
 - Press **▼ CID** or **▲** to move the cursor to the left or right.
 - Press **MUTE/DELETE** on the handset or **DELETE** on the telephone base to erase a digit.
 - **Press and hold MUTE/DELETE** on the handset or **DELETE** on the telephone base to erase all digits.
 - **Press and hold REDIAL/PAUSE** to insert a dialing pause (a **p** appears).

-OR-

Copy a number from the redial list by pressing **REDIAL/PAUSE**. Then, press **▼ CID**, **▲** or **REDIAL/PAUSE** repeatedly to find the desired number. Press **INSERT** to copy the number.

5. Press **NEXT** to move to the name.
6. When the screen displays **Enter name**, use the dialing keys to enter a name.
 - Press **▼ CID** or **▲** to move the cursor to the left or right.
 - Press **0** to add a space.
 - Press **MUTE/DELETE** on the handset or **DELETE** on the telephone base to erase a character.
 - **Press and hold MUTE/DELETE** on the handset or **DELETE** on the telephone base to erase all characters.
 - Press **TONE X** to change the next letter to upper or lower case.
7. Press **SAVE** to store your block list entry.

NOTES

- Numbers saved in your phonebook can also be saved to the block list.
- If you save a block entry that has already been saved to the allow list, the entry in the allow list will be removed.

Review block list:

Using a cordless handset or the telephone base:

1. Press **CALL BLOCK** on the handset or telephone base to enter the call block menu when the telephone is not in use.

- OR -

1. Press **MENU** on the handset or telephone base in idle mode to enter the main menu. Then, press **▼ CID** or **▲** to scroll to **Smart call blk.** Press **SELECT**.
2. Press **▼ CID** or **▲** to highlight **Block list**, and then press **SELECT**.
3. Press **▼ CID** or **▲** on the handset or telephone base to browse through the block entries.

Save a caller ID log entry to the block list:

Using a cordless handset or the telephone base:

1. Select a desired entry in the caller ID log (see **Review a caller ID log entry**).
2. When the desired entry appears, press **SAVE**.
3. Press **▼ CID** or **▲** to highlight **Block list**, and then press **SELECT**. The screen displays **Edit number**.
4. Use the dialing keys to edit the number.
 - Press **▼ CID** or **▲** to move the cursor to the left or right.
 - Press **MUTE/DELETE** on the handset or **DELETE** on the telephone base, or press **BACKSP** to erase a digit.
 - **Press and hold MUTE/DELETE** on the handset or **DELETE** on the telephone base to erase all digits.
 - **Press and hold REDIAL/PAUSE** to insert a dialing pause (a **p** appears).
5. Press **NEXT**. The screen displays **Edit name**.
6. Use the dialing keys to edit the name.
 - Press **▼ CID** or **▲** to move the cursor to the left or right.
 - Press **0** to add a space.
 - Press **MUTE/DELETE** on the handset or **DELETE** on the telephone base, or press **BACKSP** to erase a character.
 - **Press and hold MUTE/DELETE** on the handset or **DELETE** on the telephone base to erase all characters.
 - Press **#** (pound key) to move the last word to the front. For example, **Johnson Charlie** becomes **Charlie Johnson** when you press **#** (pound key).
7. Press **SAVE** to confirm. The screen shows **Saved to block list**.

Edit a block list entry:

Using a cordless handset or the telephone base:

1. Search for the desired entry in the block list (see **Review block list:**).
2. When the desired entry appears, press **EDIT**. The screen displays **Edit number** along with the phone number to be edited. If you only want to edit the name, skip to Step 4.
3. To edit the number.
 - Press **▼ CID** or **▲** to move the cursor to the left or right.
 - Press **MUTE/DELETE** on the handset or **DELETE** on the telephone base, or press **BACKSP** to erase a digit.
 - **Press and hold MUTE/DELETE** on the handset or **DELETE** on the telephone base to erase all digits.
 - **Press and hold REDIAL/PAUSE** to insert a dialing pause (a **p** appears).
4. Press **NEXT** to move on to the name. The screen displays **Edit name** along with the name to be edited.
5. Use the dialing keys to edit the name.
 - Press **▼ CID** or **▲** to move the cursor to the left or right.
 - Press **0** to add a space.
 - Press **MUTE/DELETE** on the handset or **DELETE** on the telephone base, or press **BACKSP** to erase a character.
 - **Press and hold MUTE/DELETE** on the handset or **DELETE** on the telephone base to erase all characters.
 - Press **TONEX** to change the next letter to upper or lower case.
6. Press **SAVE** to confirm. The screen shows **Saved to block list**.

Delete a block list entry:

Using a cordless handset or the telephone base:

1. Search for the desired entry in the block list (see **Review block list:**).
2. When the desired entry displays, press **MUTE/DELETE** on the handset or **DELETE** on the telephone base. The screen shows **Delete entry?**
3. Press **YES** to confirm. The screen show **Entry deleted**, and the next entry displays. You cannot retrieve a deleted entry.

NOTE

- If the call block list is empty after an entry is deleted, the screen displays **Block list is empty**.

Delete all block list entries:

Using a cordless handset or the telephone base:

1. Press **MENU** on the handset or telephone base in idle mode to enter the main menu.
2. Press **▼ CID** or **▲** to scroll to **Smart call blk**, then press **SELECT**.
3. Press **▼ CID** or **▲** to scroll **Block list**, and then press **SELECT**.
4. Press **▼ CID** or **▲** to scroll **Delete all**, and then press **SELECT**. The screen shows **Delete all in block list?**
5. Press **YES** to confirm. The screen displays **Deleted**. There is a confirmation tone.

Allow list

Add numbers that you want to allow their calls to get through to you. The allow list stores up to 200 entries.

Add an allow list entry:

Using a cordless handset or the telephone base:

1. Press **CALL BLOCK** on the handset or telephone base to enter the call block menu when the telephone is not in use.
- OR -
1. Press **MENU** on the handset or telephone base in idle mode to enter the main menu. Then, press **▼ CID** or **▲** to scroll to **Smart call blk**. Press **SELECT**.
 2. Press **▼ CID** or **▲** to highlight **Allow list**, and then press **SELECT**.
 3. Press **▼ CID** or **▲** to highlight **Add new entry**, and then press **SELECT**.
 4. When the screen displays **Enter number**, use the dialing keys to enter the number.
 - Press **▼ CID** or **▲** to move the cursor to the left or right.
 - Press **MUTE/DELETE** on the handset or **DELETE** on the telephone base to erase a digit.
 - **Press and hold MUTE/DELETE** on the handset or **DELETE** on the telephone base to erase all digits.
 - **Press and hold REDIAL/PAUSE** to insert a dialing pause (a **p** appears).

-OR-

Copy a number from the redial list by pressing **REDIAL/PAUSE**. Then, press **▼ CID**, **▲** or **REDIAL/PAUSE** repeatedly to find the desired number. Press **INSERT** to copy the number.

5. Press **NEXT** to move to the name.
6. When the screen displays **Enter name**, use the dialing keys to enter a name.
 - Press **▼ CID** or **▲** to move the cursor to the left or right.
 - Press **0** to add a space.
 - Press **MUTE/DELETE** on the handset or **DELETE** on the telephone base to erase a character.
 - **Press and hold MUTE/DELETE** on the handset or **DELETE** on the telephone base to erase all characters.
 - Press **TONEX** to change the next letter to upper or lower case.
7. Press **SAVE** to store your allow list entry.

NOTES

- Numbers saved in your phonebook can also be saved to the allow list.
- If you save an allow list entry that has already been saved to the block list, the entry in the block list will be removed.

Review allow list:

Using a cordless handset or the telephone base:

1. Press **CALL BLOCK** on the handset or telephone base to enter the call block menu when the telephone is not in use.
- OR -
1. Press **MENU** on the handset or telephone base in idle mode to enter the main menu. Then, press **▼ CID** or **▲** to scroll to **Smart call blk**. Press **SELECT**.
 2. Press **▼ CID** or **▲** to highlight **Allow list**, and then press **SELECT**.
 3. Press **▼ CID** or **▲** on the handset or telephone base to browse through the allow list entries.

Save a caller ID log entry to the allow list:

Using a cordless handset or the telephone base:

1. Select a desired entry in the caller ID log (see **Review the caller ID log**).
2. When the desired entry appears, press **SAVE**.
3. Press **▼ CID** or **▲** to highlight **Allow list**, and then press **SELECT**. The screen displays **Edit number**.
4. Use the dialing keys to edit the number.
 - Press **▼ CID** or **▲** to move the cursor to the left or right.
 - Press **MUTE/DELETE** on the handset or **DELETE** on the telephone base, or press **BACKSP** to erase a digit.
 - **Press and hold MUTE/DELETE** on the handset or **DELETE** on the telephone base to erase all digits.
 - **Press and hold REDIAL/PAUSE** to insert a dialing pause (a **p** appears).
5. Press **NEXT**. The screen displays **Edit name**.
6. Use the dialing keys to edit the name.
 - Press **▼ CID** or **▲** to move the cursor to the left or right.
 - Press **0** to add a space.
 - Press **MUTE/DELETE** on the handset or **DELETE** on the telephone base, or press **BACKSP** to erase a character.
 - **Press and hold MUTE/DELETE** on the handset or **DELETE** on the telephone base to erase all characters.
 - Press **#** (pound key) to move the last word to the front. For example, **Johnson Charlie** becomes **Charlie Johnson** when you press **#** (pound key).
7. Press **SAVE** to confirm. The screen shows **Saved to allow list**.

Edit an allow list entry:

Using a cordless handset or the telephone base:

1. Search for the desired entry in the allow list (see **Review allow list:**).
2. When the desired entry appears, press **EDIT**. The screen displays **Edit number** along with the phone number to be edited. If you only want to edit the name, skip to Step 4.
3. To edit the number.
 - Press **▼ CID** or **▲** to move the cursor to the left or right.
 - Press **MUTE/DELETE** on the handset or **DELETE** on the telephone base, or press **BACKSP** to erase a digit.
 - **Press and hold MUTE/DELETE** on the handset or

DELETE on the telephone base to erase all digits.

- **Press and hold REDIAL/PAUSE** to insert a dialing pause (a **p** appears).
4. Press **NEXT** to move on to the name. The screen displays **Edit name** along with the name to be edited.
 5. Use the dialing keys to edit the name.
 - Press **▼ CID** or **▲** to move the cursor to the left or right.
 - Press **0** to add a space.
 - Press **MUTE/DELETE** on the handset or **DELETE** on the telephone base, or press **BACKSP** to erase a character.
 - **Press and hold MUTE/DELETE** on the handset or **DELETE** on the telephone base to erase all characters.
 - Press **TONEX** to change the next letter to upper or lower case.
 6. Press **SAVE** to confirm. The screen shows **Saved to allow list**.

Delete an allow list entry:

Using a cordless handset or the telephone base:

1. Search for the desired entry in the allow list (see **Review allow list:**).
2. When the desired entry displays, press **MUTE/DELETE** on the handset or **DELETE** on the telephone base. The screen shows **Delete entry?**
3. Press **YES** to confirm. The screen show **Entry deleted**, and the next entry displays. You cannot retrieve a deleted entry.

NOTE

- If the allow list is empty after an entry is deleted, the screen displays **Allow list is empty**.

Delete all allow list entries:

Using a cordless handset or the telephone base:

1. Press **CALL BLOCK** on the handset or telephone base to enter the call block menu when the telephone is not in use.
- OR -
1. Press **MENU** on the handset or telephone base in idle mode to enter the main menu. Then, press **▼ CID** or **▲** to scroll to **Smart call blk**. Press **SELECT**.
 2. Press **▼ CID** or **▲** to scroll **Allow list**, and then press **SELECT**.
 3. Press **▼ CID** or **▲** to scroll **Delete all**, and then press **SELECT**. The screen shows **Delete all in allow list?**
 4. Press **YES** to confirm. The screen displays **Deleted**. There is a confirmation tone.





Star name list

There are many organizations like schools, medical offices, and pharmacies that use robocalls to communicate important information to you. Robocall uses an autodialer to deliver pre-recorded messages. By entering the name of the organizations into the star name list, it ensures these calls will ring through when you only know the caller names but not their numbers.

If the first 15 characters of the incoming caller ID's name match a name saved in your star name list, the call will get through and ring. The star name list stores up to 10 names.



Add a star name entry:

Using a cordless handset or the telephone base:

1. Press **CALL BLOCK** on the handset or telephone base to enter the call block menu when the telephone is not in use.
- OR -
1. Press **MENU** on the handset or telephone base in idle mode to enter the main menu. Then, press ▼ **CID** or ▲  to scroll to **Smart call blk**. Press **SELECT**.
2. Press ▼ **CID** or ▲  to highlight **Star name list**, and then press **SELECT**.
3. Press ▼ **CID** or ▲  to highlight **Add new entry**, and then press **SELECT**.
4. When the screen displays **Enter name**, use the dialing keys to enter a name. Press a key repeatedly until the desired character appears. The first character of every word is capitalized.
 - Press ▼ **CID** or ▲  to move the cursor to the left or right.
 - Press **0** to add a space.
 - Press **MUTE/DELETE** on the handset or **DELETE** on the telephone base to erase a character.
 - Press and hold **MUTE/DELETE** on the handset or **DELETE** on the telephone base to erase all characters.
 - Press **TONE X** to change the next letter to upper or lower case.
5. Press **SAVE** to store your star name entry.

Review star name list:

Using a cordless handset or the telephone base:

1. Press **CALL BLOCK** on the handset or telephone base to enter the call block menu when the telephone is not in use.
- OR -
1. Press **MENU** on the handset or telephone base in idle mode to enter the main menu. Then, press ▼ **CID** or ▲  to scroll to **Smart call blk**. Press **SELECT**.
2. Press ▼ **CID** or ▲  to highlight **Star name list**, and then press **SELECT**.
3. Press ▼ **CID** or ▲  on the handset or telephone base to browse through the star name entries.

Save a caller ID log entry to the star name list:

Using a cordless handset or the telephone base:

1. Select a desired entry in the caller ID log (see **Review the caller ID log**).
2. When the desired entry appears, press **SAVE**.
3. Press ▼ **CID** or ▲  to highlight **Star name list**, and then press **SELECT**. The screen displays **Star this name?** and then the caller's name.
4. Press **SELECT** to confirm. The screen shows **Saved to star name list**.

Edit a star name list entry:

Using a cordless handset or the telephone base:

1. Search for the desired entry in the star name list (see **Review star name list**).
2. When the desired entry appears, press **EDIT**. The screen displays **Edit name** along with the name to be edited.
3. Use the dialing keys to edit the name.
 - Press ▼ **CID** or ▲  to move the cursor to the left or right.
 - Press **0** to add a space.
 - Press **MUTE/DELETE** on the handset or **DELETE** on the telephone base, or press **BACKSP** to erase a character.
 - Press and hold **MUTE/DELETE** on the handset or **DELETE** on the telephone base to erase all characters.
 - Press **TONE X** to change the next letter to upper or lower case.
4. Press **SAVE** to confirm. The screen shows **Saved to star name list**.



Delete a star name list entry:

Using a cordless handset or the telephone base:

1. Search for the desired entry in the star name list (see **Review star name list**).
2. When the desired entry displays, press **MUTE/DELETE** on the handset or **DELETE** on the telephone base. The screen shows **Delete entry?**.
3. Press **YES** to confirm. The screen show **Entry deleted**, and the next entry displays. You cannot retrieve a deleted entry.

Delete all star name list entries:

Using a cordless handset or the telephone base:

1. Press **CALL BLOCK** on the handset or telephone base to enter the call block menu when the telephone is not in use.
- OR -
1. Press **MENU** on the handset or telephone base in idle mode to enter the main menu. Then, press ▼ **CID** or ▲  to scroll to **Smart call blk**. Press **SELECT**.
2. Press ▼ **CID** or ▲  to scroll **Star name list**, and then press **SELECT**.
3. Press ▼ **CID** or ▲  to scroll **Delete all**, and then press **SELECT**. The screen shows **Delete all in star name list?**.
4. Press **YES** to confirm. The screen displays **Deleted**. There is a confirmation tone.

Screening announcements

If you have set profile to screen all unknown home calls (**Screen unknown**) or screen robocalls (**Screen robot**), the callers of the following incoming call categories will hear a screening announcement.

- Home calls that are "out of area" or with numbers set to "Private".
- Home calls with numbers that are not in your phonebook, allow list, or block list, or with absent caller ID number.
- Home calls with caller ID names that are not in your star name list.

There are two default screening announcements for screening unknown calls and screening robocalls on home line.

Screening with caller name - *"Hello. Calls to this number are being screened by Smart call blocker. Please say your name after the tone, then press pound."*

-OR-





Screening without caller name - *"Hello. Calls to this number are being screened by Smart call blocker. If you're a family member, friend or invited caller, please press pound to be connected. If you're a solicitor, please hang up now."*

- This default announcement is played if you have set profile to screen robocalls on home line.

You can use these announcements, or record your own name to replace "this number" in both announcements. See **Record your name for all screening announcements** section below.





Play your current announcement of screening with caller name:

Using a cordless handset or the telephone base:

1. Press **CALL BLOCK** on the handset or telephone base to enter the call block menu when the telephone is not in use.
- OR -
1. Press **MENU** on the handset or telephone base in idle mode to enter the main menu. Then, press ▼ **CID** or ▲  to scroll to **Smart call blk**. Press **SELECT**.
2. Press ▼ **CID** or ▲  on the handset or telephone base to scroll to **Screening annnc**, then press **SELECT**.
3. Press ▼ **CID** or ▲  on the handset or telephone base to scroll to **Play annnc**, then press **SELECT**.
4. Press ▼ **CID** or ▲  on the handset or telephone base to scroll to **w/ Caller name**, then press **SELECT**.



Play your current announcement of screening without caller name:

Using a cordless handset or the telephone base:

1. Press **CALL BLOCK** on the handset or telephone base to enter the call block menu when the telephone is not in use.
- OR -
1. Press **MENU** on the handset or telephone base in idle mode to enter the main menu. Then, press ▼ **CID** or ▲  to scroll to **Smart call blk**. Press **SELECT**.
2. Press ▼ **CID** or ▲  on the handset or telephone base to scroll to **Screening annnc**, then press **SELECT**.
3. Press ▼ **CID** or ▲  on the handset or telephone base to scroll to **Play annnc**, then press **SELECT**.
4. Press ▼ **CID** or ▲  on the handset or telephone base to scroll to **w/o Caller name**, then press **SELECT**.

Record your name for all screening announcements:



Using a cordless handset or the telephone base:

1. Press **CALL BLOCK** on the handset or telephone base to enter the call block menu when the telephone is not in use.
- OR -
1. Press **MENU** on the handset or telephone base in idle mode to enter the main menu. Then, press ▼ **CID** or ▲  to scroll to **Smart call blk**. Press **SELECT**.
2. Press ▼ **CID** or ▲  on the handset or telephone base to scroll to **Screening annnc**, then press **SELECT**.
3. Press ▼ **CID** or ▲  on the handset or telephone base to scroll to **Rec your name**, then press **SELECT**. The system announces, *"Record after the tone. Press stop when you are done."*
4. Speak towards the handset to record your name, if you are using the handset, or speak towards the telephone base to record your name, if you are using the telephone base. Press **STOP** to end recording.

To listen to the announcement with your recorded name again, scroll to **Play annnc** and press **SELECT**.

Reset all your screening announcements:

Using a cordless handset or the telephone base:

1. Press **CALL BLOCK** on the handset or telephone base to enter the call block menu when the telephone is not in use.
- OR -
 1. Press **MENU** on the handset or telephone base in idle mode to enter the main menu. Then, press ▼ **CID** or ▲  to scroll to **Smart call blk.** Press **SELECT**.
 2. Press ▼ **CID** or ▲  on the handset or telephone base to scroll to **Screening annnc**, then press **SELECT**.
 3. Press ▼ **CID** or ▲  on the handset or telephone base to scroll to **Reset annnc**, then press **SELECT**. The screen shows **Reset to default annnc?**. Press **YES** to confirm. The screen shows **Annnc. reset to default** before returning to the previous menu.



-OR-

While an announcement is playing, press **MUTE/DELETE** on the handset, or press **DELETE** on the telephone base. The screen shows **Annnc. Deleted** before returning to the previous menu.

Your name will be deleted from all the screening announcements, and the telephone will use the default screening announcements. See **Screening announcements**.

Voice guide to set Smart call blocker

This feature is an easy and alternative way for you to do the basic setup of Smart call blocker. You can follow the voice guide to set your telephone system to allow or to screen all incoming home calls, or to screen home calls that do not display a phone number.

1. Press **CALL BLOCK** on the handset or telephone base to enter the call block menu when the telephone is not in use.
- OR -
 1. Press **MENU** on the handset or telephone base in idle mode to enter the main menu. Then, press ▼ **CID** or ▲  to scroll to **Smart call blk.** Press **SELECT**.
 2. Press ▼ **CID** or ▲  to scroll to **Voice guide**, then press **SELECT**. You hear a voice prompt, *"Hello! This voice guide will assist you with the basic setup of Smart call blocker..."*
 3. Set up your Smart call blocker feature by inputting designated numbers, as instructed in the voice guide.
 - Press **1** if you want to screen home calls with telephone numbers that are not saved in your phonebook, allow list or star name list; or
 - Press **2** if you do not want to screen calls, and want to allow all incoming calls to get through.

NOTES

- The screening feature of Smart call blocker is applicable to home calls only. All incoming cell calls will get through and ring. If you want to block a cell call, add the number to the block list. See **Block list**.
- You can press **OFF/CANCEL** on the handset or press **CANCEL** on the telephone base to quit the voice guide at any time.
- After a power outage, the system prompts you to set the date and time. After the date and time setting is done or skipped, the system then prompts if you want to set up Smart call blocker via voice guide. Press **YES** to start the setup.

Allowed calls

If Smart call blocker is on, the following types of incoming calls can get through to you and ring on your telephone system:

- Home calls with numbers saved in your allow list.
- Home calls with numbers saved in your phonebook, but not in your block list.
- Home calls with caller ID names saved in your star name list.
- Cell calls with numbers not saved in your block list.

NOTES

- When Smart call blocker is off, all incoming calls will ring on your telephone system, including calls with numbers saved in the block list.
- **Allow unknown** is the default profile setting. If you have not selected another profile, all unknown home calls will ring. However, the caller's numbers, if available, will not be saved to the allow list. If you want to save the caller's number to your allow list or block list, you can retrieve the number from caller ID log and save it to the allow list or block list. See **Save a caller ID log entry to the block list** and **Save a caller ID log entry to the allow list**. If you want to retrieve the name from caller ID log and save it to the star name list. See **Save a caller ID log entry to the star name list**.

Blocked calls

If Smart call blocker is on, incoming home or cell calls with numbers saved in your block list will not ring. The telephone plays the block announcement *"Calls to this number are being screened by Smart call blocker. The number you are calling is not accepting your call. Please hang up."* to the caller, and the call will be terminated.

NOTE

- When Smart call blocker is off, all incoming home and cell calls will ring on your telephone system, including calls with numbers saved in the block list.
- If you have set profile to **Block unknown**, all unknown home calls will be rejected. However, the caller's numbers, if available, will not be saved to the block list. If you want to save the caller's number to the block list, you can retrieve the number from caller ID log and save it to the block list. See **Save a caller ID log entry to the block list**. You can also retrieve the number and save it to your allow list. See **Save a caller ID log entry to the allow list**. If you want to retrieve the name from caller ID log and save it to the star name list. See **Save a caller ID log entry to the star name list**.
- The telephone can respond to remote access code while it is playing the block announcement. This allows you to access your answering system from an unknown number remotely. See **Remote access**.

Screen unknown home calls

If Smart call blocker is on, and you have set profile to screen unknown home calls, the telephone plays a screening announcement to the caller when receiving the following incoming home calls. It asks the caller to respond before putting the call through to you.

- Incoming home calls with numbers that are “out of area” or with numbers set to “Private”;
- Incoming home calls with absent caller ID numbers;
- Incoming home calls with numbers that are not in your phonebook, allow list, nor block list; or
- Incoming home calls with names that are not in your star name list.

Screen calls and ask for caller names

When screening a home call, the telephone announces to the caller, “Hello. Calls to this number are being screened by Smart call blocker. Please say your name after the tone, then press pound.” After the caller completes the request, the telephone announces to the caller “Please wait a moment while your call is connected.”. The telephone starts ringing and displays **Screened call**. After you pick up the call, the telephone announces the caller’s name, and then asks whether you want to answer or reject the call, or to forward the call to the answering system.

NOTES

- You can set Smart call blocker to screen and filter all unknown home calls. You can easily add incoming phone numbers to your allow list and block list. This allows you to build up your lists of allowed and blocked numbers, and Smart call blocker will know how to deal with these calls when they come in again.
- The telephone announces to the caller with “Hello. Calls to this number are being screened by Smart call blocker...” If you have recorded your name in the screening announcements, your recorded name will replace “this number” in the announcements. See **Screening announcements**.
- The screening feature of Smart call blocker is applicable to home calls only.
- If the caller hangs up before the call is screened, or without leaving his/her name while the call is being screened, the call will be logged as missed call in the caller ID log.
- While a call is being screened, you can press **ANSWER**, **HOME/FLASH** or **PHONE** to stop screening and answer the call.
- After the telephone screened a call, and is ringing and announcing the caller’s name, you can press **OFF/CANCEL** or **SILENCE** to silence the ringer, or press **BLOCK** to reject the call directly.
- After you picked up a screened call and the telephone is announcing the screening options, you can press **OFF/CANCEL** to hang up the call.
- If Smart call blocker is on and you receive a call waiting home call:
 - Smart call blocker will not screen a call waiting home call without number while on a call. You can press **ANSWER**, **HOME/FLASH** or **PHONE** to take the new call.
 - After you have picked up a screened home call, the telephone checks whether the call waiting number is in the phonebook, block list or allow list. It also checks whether the caller name is in the star name list. After that, The telephone then displays the caller ID information or “Blocked call” accordingly. You can press **ANSWER**, **HOME/FLASH** or **PHONE** to take the new call, or press

CALL BLOCK on the handset to block it.

- While the telephone is screening a home call, the new call will be ignored and logged as missed call in the caller ID log.
- Robocalls are unable to respond to the screening announcement, and therefore, will not get through and ring. If you want to allow some robocalls to get through, save their names in the star name list. See **Star name list**.
- The telephone can respond to remote access code while it is playing the screening announcement. This allows you to access your answering system from an unknown number remotely. See **Remote access**.

Screened call options

After the telephone screen a home call and starts ringing, the handset screen displays **Screened call**. Press **HOME/FLASH** or **PHONE** to pick up the call.

After you picked up the call, the telephone announces “Call from...” and the caller’s name, and then announces, “To answer the call, press 1. To answer and always allow this number, press 2. To block this number, press 3. To send this call to the answering system, press 4. To repeat these options, press *”.

Allow this call once:

- Press **1** to answer the call. The telephone number will not be added to your allow list.

Always allow this call:

- Press **2** to answer the call. The telephone number will be added to your allow list.

Block this call:

- Press **3** or **CALL BLOCK** to block the call. The telephone plays the block announcement “The number you are calling is not accepting your call. Please hang up.” to the caller. The telephone number will be added to your block list.

Send this call to the answering system:

- Press **4** to forward the call to the answering system.

End this call:

- If you do not want to take the call, press **OFF/CANCEL** on the handset or press **CANCEL** on the telephone base to end the call.

NOTES

- For home calls that are “out of area”, “Private”, or without caller ID, only options **1** and **4** will be available. The telephone announces “To answer the call, press 1. To send this call to the answering system, press 4. To repeat these options, press *”.
- If you select option **4** to send the call to the answering system, the caller can leave a message even if the answering system is off.
- When the telephone is ringing, you can press **MUTE/DELETE** on the handset or **DELETE** on the telephone base to mute the ringer temporarily.

Screen robocalls

If Smart call blocker is on, and you have set profile to screen robocalls, the telephone plays a screening announcement to the caller when receiving the following incoming home calls. It asks the caller to press the pound key (#) before putting the call through to you.

- Incoming home calls with numbers that are “out of area” or with numbers set to “Private”;
- Incoming home calls with absent caller ID numbers;
- Incoming home calls with numbers that are not in your phonebook, allow list, nor block list; or
- Incoming home calls with names that are not in your star name list.

Screen calls without asking for caller names

When screening a home call, the telephone announces to the caller, “Hello. Calls to this number are being screened by Smart call blocker. If you’re a family member, friend or invited caller, please press pound to be connected. If you’re a solicitor, please hang up now.” After the caller presses the pound key (#), the telephone announces to the caller “Please wait a moment while your call is connected.”. The telephone starts ringing, and you can answer the call.

This option is suitable for you to filter calls that uses autodialers to deliver prerecorded messages, for example, robocalls and telemarketing calls.

NOTES

- The telephone announces to the caller with “Hello. Calls to this number are being screened by Smart call blocker...” If you have recorded your name in the screening announcements, your recorded name will replace “this number” in the announcements. See **Screening announcements**.
- The screening feature of Smart call blocker is applicable to home calls only.
- If the caller hangs up before the home call is screened, or without leaving his/her name while the call is being screened, the call will be logged as missed call in the caller ID log.
- While a home call is being screened, you can press **ANSWER**, **HOME/FLASH** or **PHONE** to stop screening and answer the call.
- If Smart call blocker is on and you receive a call waiting home call:
 - Smart call blocker will not screen a call waiting home call without number while on a call. You can press **ANSWER**, **HOME/FLASH** or **PHONE** to take the new call.
 - After you have picked up a screened home call, the telephone checks whether the call waiting number is in the phonebook, block list or allow list. It also checks whether the caller name is in the star name list. After that, The telephone then displays the caller ID information or “Blocked call” accordingly. You can press **ANSWER**, **HOME/FLASH** or **PHONE** to take the new call, or press **CALL BLOCK** to block it.
 - While the telephone is screening a home call, the new call will be ignored and logged as missed call in the caller ID log.
- Robocalls are unable to respond to the screening announcement, and therefore, will not get through and ring. If you want to allow some robocalls to get through, save their names in the star name list. See **Star name list**.
- The telephone can respond to remote access code while it is playing the screening announcement. This allows you to access your answering system from an unknown number remotely. See **Remote access**.

Option while on a call

When you are on a home or cell call and speaking to the caller, and you do not want to continue the call, you can press **BLOCK** to end the call. The telephone plays the block announcement “The number you are calling is not accepting your call. Please hang up.” to the caller, and the call will be terminated. The caller’s number, if available, will be added to your block list.

Using a cordless handset or the telephone base:

- Press **BLOCK**. The screen displays **Block and end?** and the caller’s number, if available. Press **YES** to end the call.

NOTES

- The caller’s number, if available, will be saved to the block list. The screen displays **Added to block list** after pressing **YES**. If caller’s number is not available, the screen displays **No number available to block..**
- You can press **BLOCK** to end the call even if Smart call blocker is turned off.

About the built-in answering system and voicemail service

For message recording, your telephone has a built-in answering system, and it also supports voicemail service offered by your telephone service provider (subscription is required, and fee may apply).

The main differences between them are:

	BUILT-IN ANSWERING SYSTEM	VOICEMAIL SERVICE
SUPPORTED BY	Telephone system	Telephone service provider
SUBSCRIPTION	No	Yes
FEES	No	May apply
ANSWER INCOMING CALLS	<ul style="list-style-type: none"> After 3 rings by default. It can be changed via handset or the telephone base menu. 	<ul style="list-style-type: none"> Usually after 2 rings. It can be changed by contacting your telephone service provider.
STORAGE	Telephone base	Server or System
DISPLAY NEW MESSAGES	<ul style="list-style-type: none"> Handset - XX new messages Telephone base - XX new messages 	<ul style="list-style-type: none"> Handset - and New voicemail Telephone base -
RETRIEVE MESSAGES	<ul style="list-style-type: none"> Press PLAY / STOP on the telephone base; OR Press MENU, and then select Play messages on the handset; OR Access remotely with an access code. 	<ul style="list-style-type: none"> Press on the dialpad, and enter an access number from your telephone service provider.

Set your built-in answering system

The answering system can record and store up to 99 messages. Each message can be up to three minutes in length. The total storage capacity for the announcement, messages and memos is approximately 22 minutes. The actual recording time depends on individual message characteristics.

Your answering system allows you to set your announcement, to save and delete messages, activate call screening, to set number of rings before pick up, to access remotely, and to control the recording time.

Turn the answering system on or off

The answering system must be turned on to answer and record messages.

When the answering system is turned on, the **ANS ON** light on the telephone base turns on and **ANS ON** displays on the handset.

To turn on or off with the telephone base:

- Press **ANS ON** to turn the built-in answering system on or off. When the answering system is turned on, it announces, "Calls will be answered." When the answering system is turned off, it announces, "Calls will not be answered."

-OR-

- When the telephone base is in idle mode, press **MENU** to enter the main menu.
- Press **SELECT** to select **Answering sys.**
- Press **▼ CID** or **▲** to scroll to **Answer ON/OFF**, then press **SELECT**.
- Press **▼ CID** or **▲** to highlight **On** or **Off**, then press **SELECT** to save the setting. You hear a confirmation tone.

NOTE

- If the answering system is off and there is an incoming call, the system answers after ten rings and announces, "Please enter your remote access code." See **Remote access**.

To turn on or off with the handset:

- When the handset is in idle mode, press **MENU** to enter the main menu.
- Press **▼ CID** or **▲** to scroll to **Answering sys.**, then press **SELECT**.
- Press **▼ CID** or **▲** to scroll to **Answer On/Off**, then press **SELECT**.
- Press **▼ CID** or **▲** to highlight **On** or **Off**, then press **SELECT** to save the setting. You hear a confirmation tone.

When the answering system is on, the handset shows **ANS ON**.

Default announcement

The telephone is preset with a greeting that answers calls with "Hello, please leave a message after the tone." You can use this preset announcement, or replace it with your own.

Record your own announcement

The announcement can be up to 90 seconds in length.

Using a cordless handset:

- Press **MENU** when the phone is not in use.
- Press **▼ CID** or **▲** to choose **Answering sys** then press **SELECT**.
- Press **SELECT** to select **Announcement**.
- Press **SELECT** to select **Record annnc**. The system announces, "Record after the tone. Press STOP when you are done."
- Speak towards the handset to record your announcement. Press **STOP** to end recording. Your recorded announcement plays.

To listen to the recorded announcement again, scroll to **Play annnc** and press **SELECT**.

Using the telephone base:

- Press **MENU** when the phone is not in use.
- Press **SELECT** to select **Answering sys.**
- Press **SELECT** to select **Announcement**.
- Press **SELECT** to select **Record annnc**. The system announces, "Record after the tone. Press STOP when you are done."
- Speak towards the telephone base to record your announcement. Press **STOP** to end recording. Your recorded announcement plays.

To listen to the recorded announcement again, scroll to **Play annnc** and press **SELECT**.

NOTE

- Announcements shorter than two seconds will not be recorded.

Play the announcement

Using a cordless handset:

- Press **MENU** when the phone is not in use.
- Press **▼ CID** or **▲** to choose **Answering sys**, and then press **SELECT**.
- Press **SELECT** to select **Announcement**.
- Press **▼ CID** or **▲** to select **Play annnc**, and then press **SELECT**.

Using the telephone base:

- Press **MENU** when the phone is not in use.
- Press **SELECT** to select **Answering sys.**
- Press **SELECT** to select **Announcement**.
- Press **▼ CID** or **▲** to select **Play annnc**, and then press **SELECT**.

Options during playback:

- Press **▼ CID** or **▲** on the handset, or press **VOL+** or **VOL-** on the telephone base to adjust the listening volume.
- Press **5** or **OFF** to stop at any time.

Delete the announcement

Using a cordless handset:

- Press **MENU** when the phone is not in use.
- Press **▼ CID** or **▲** to choose **Answering sys**, and then press **SELECT**.
- Press **SELECT** to select **Announcement**.
- Press **▼ CID** or **▲** to select **Play annnc**, and then press **SELECT**.
- While the announcement is playing, press **MUTE/DELETE** to delete the announcement. The system announces "Announcement deleted".

-OR-

- When the handset is in idle mode, press **MENU** to enter the main menu.
- Press **▼ CID** or **▲** to scroll to **Answering sys**, then press **SELECT**.
- Press **SELECT** again to select **Announcement**.
- Press **▼ CID** or **▲** to scroll to **Reset annnc**, then press **SELECT**. The screen shows **Reset to default annnc?**
- Press **YES** to confirm. The screen shows **Annnc. reset to default**.

Using the telephone base:

- Press **MENU** when the telephone is not in use.
- Press **SELECT** to select **Answering sys.**
- Press **SELECT** again to select **Announcement**.
- Press **▼ CID** or **▲** to select **Play annnc**, and then press **SELECT**.
- While the announcement is playing, press **DELETE** to delete the announcement. The system announces "Announcement deleted".

Telephone base control key panel:

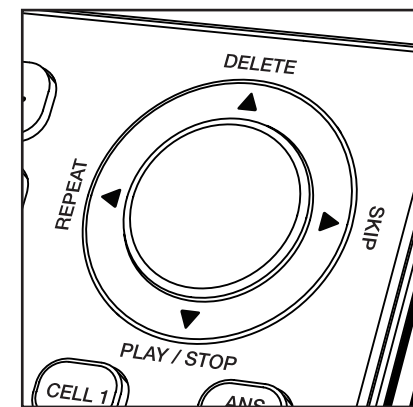

-OR-

1. When the telephone is in idle mode, press **MENU** to enter the main menu.
2. Press **SELECT** to select **Answering sys.**
3. Press **SELECT** again to select **Announcement.**
4. Press **▼ CID** or **▲** to scroll to **Reset annc**, then press **SELECT**. The screen shows **Reset to default annc?**.
5. Press **YES** to confirm. The screen shows **Annc. reset to default.**

When your announcement is deleted, the system answers calls with the default announcement (see **Default announcement**). You cannot delete the default announcement.

Voice guide to set Answering system

This feature is an alternative way for you to do the basic setup of the answering system. You can follow the voice guide to record your own announcement, set the number of rings, and set the message alert tone.

Using a cordless handset or the telephone base:

1. Press **MENU** when the phone is not in use.
2. Press **▼ CID** or **▲** to choose **Answering sys**, and then press **SELECT**.
3. Press **▼ CID** or **▲** to choose **Voice guide**, and then press **SELECT**. You hear a voice prompt, "This voice guide will assist you with the basic setup of your answering system."
4. Set up your answering system by inputting designated numbers, as instructed in the voice guide.

NOTES

- You can press **OFF/CANCEL** on the handset or press **CANCEL** on the telephone base to quit the voice guide at any time.
- If the system does not receive any input, it will play an alert message. If there is still no input, it will announce "Sorry, I still have not received any input. If you want to restart the voice guide, please enter the menu and select Voice guide under Answering system. Good bye."
- After a power outage, the system prompts you to set the date and time, and Smart call blocker. After that, the system prompts if you want to set up the answering system via voice guide. Press **YES** to start the setup.

Set number of rings

You can set the answering system to answer an incoming call after two, three, four, five or six rings. You can also select toll saver. If toll saver is selected, the answering system answers a call after two rings when you have new messages, and after four rings when there are no new messages. This feature allows you to check for new messages and avoid paying long distance charges when calling from out of your local area. By default, the answering system answers an incoming call after four rings.

To set the number of rings:

Using a cordless handset:

1. When the telephone is in idle mode, press **MENU** to enter the main menu.
2. Press **▼ CID** or **▲** to scroll to **Answering sys**, then press **SELECT**.
3. Press **▼ CID** or **▲** to scroll to **Ans sys setup**, then press **SELECT**.
4. Press **▼ CID** or **▲** to scroll to **# of rings**, then press **SELECT**.
5. Press **▼ CID** or **▲** to choose among **2, 3, 4, 5, 6** or **Toll saver**.
6. Press **SELECT** to save the setting. You hear a confirmation tone.

Using the telephone base:

1. When the telephone is in idle mode, press **MENU** to enter the main menu.
2. Press **SELECT** to select **Answering sys**.
3. Press **▼ CID** or **▲** to scroll to **Ans sys setup**, then press **SELECT**.
4. Press **▼ CID** or **▲** to scroll to **# of rings**, then press **SELECT**.
5. Press **▼ CID** or **▲** to choose among **2, 3, 4, 5, 6** or **Toll saver**.
6. Press **SELECT** to save the setting. You hear a confirmation tone.

NOTES

- If you set the number of rings for the answering system as 2 or 3 rings, the caller ID announce feature may not have enough time to announce the caller's full information.
- If Smart call blocker is on, the first ring of all incoming calls will be muted.

Set recording time

You can set the recording time allowed for incoming messages. The message length is three minutes by default.

To change the setting:

Using a cordless handset:

1. When the telephone is in idle mode, press **MENU** to enter the main menu.
2. Press **▼ CID** or **▲** to scroll to **Answering sys**, then press **SELECT**.
3. Press **▼ CID** or **▲** to scroll to **Ans sys setup**, then press **SELECT**.
4. Press **▼ CID** or **▲** to scroll to **Recording time**, then press **SELECT**.
5. Press **▼ CID** or **▲** to choose **3 minutes, 2 minutes** or **1 minute**, then press **SELECT** to save the setting. You hear a confirmation tone.

Using the telephone base:

1. When the telephone is in idle mode, press **MENU** to enter the main menu.
2. Press **SELECT** to select **Answering sys**.
3. Press **▼ CID** or **▲** to scroll to **Ans sys setup**, then press **SELECT**.
4. Press **SELECT** to select **Recording time**.
5. Press **▼ CID** or **▲** to choose **3 minutes, 2 minutes** or **1 minute**, then press **SELECT** to save the setting. You hear a confirmation tone.

Turn the call screening on or off

Use this feature to choose whether incoming messages can be heard over the speaker when they are being recorded. If you turn call screening on, you hear the incoming message. While monitoring an incoming message, you can answer the call by pressing **HOME/FLASH** on the handset, or **HOME** on the telephone base.

To change the setting:

Using a cordless handset:

1. When the telephone is in idle mode, press **MENU** to enter the main menu.
2. Press **▼ CID** or **▲** to scroll to **Answering sys**, then press **SELECT**.
3. Press **▼ CID** or **▲** to scroll to **Ans sys setup**, then press **SELECT**.
4. Press **SELECT** to select **Call screening**.
5. Press **▼ CID** or **▲** to choose **On** or **Off**, then press **SELECT**.
6. Press **SELECT** to save the setting. You hear a confirmation tone.

Using the telephone base:

1. When the telephone is in idle mode, press **MENU** to enter the main menu.
2. Press **SELECT** to select **Answering sys**.
3. Press **▼ CID** or **▲** to scroll to **Ans sys setup**, then press **SELECT**.
4. Press **SELECT** to select **Call screening**.
5. Press **▼ CID** or **▲** to choose **On** or **Off**, then press **SELECT**.
6. Press **SELECT** to save the setting. You hear a confirmation tone.

NOTE

- For more information on call screening, see **Call screening**.

Turn the message alert tone on or off

When the message alert tone is set to On, and there is at least one new message, the telephone base beeps every ten seconds. Unless you change it, the message alert tone is set to off.

There is no audible alert at the handset.

To change the setting:

Using a cordless handset:

1. When the telephone is in idle mode, press **MENU** to enter the main menu.
2. Press **▼ CID** or **▲** to scroll to **Answering sys**, then press **SELECT**.
3. Press **▼ CID** or **▲** to scroll to **Ans sys setup**, then press **SELECT**.
4. Press **▼ CID** or **▲** to scroll to **Msg alert tone**, then press **SELECT**.
5. Press **▼ CID** or **▲** to choose **On** or **Off**.
6. Press **SELECT** to save the setting. You hear a confirmation tone.

Using the telephone base:

1. When the telephone is in idle mode, press **MENU** to enter the main menu.
2. Press **SELECT** to select **Answering sys**.
3. Press **▼ CID** or **▲** to scroll to **Ans sys setup**, then press **SELECT**.
4. Press **▼ CID** or **▲** to scroll to **Msg alert tone**, then press **SELECT**.
5. Press **▼ CID** or **▲** to choose **On** or **Off**.
6. Press **SELECT** to save the setting. You hear a confirmation tone.

NOTES

- The message alert tone beeps only if all the following conditions are met:
 - Answering system is on.
 - Message alert tone setting is on.
 - There are new messages.
- Press any key on the telephone base (except **FIND HS**) to temporarily silence the message alert tone.

Answering system and voicemail indicators

Your telephone has separate indicators for two different types of voice messages: those left on its built-in digital answering system and those left at your telephone service provider's voicemail (fees may apply). Your telephone's built-in digital answering system messages and voicemail messages are separate. Each alerts you to new messages differently.

- If **OO** and **XX New msgs** show on the handset and **XX New messages** shown on the telephone base, there are new messages in the built-in answering system. To listen to messages recorded on your digital answering system, press **PLAY/STOP** on the telephone base.
- If **VM** and **New voicemail** display on the handset and the telephone base, your telephone service provider is indicating that it has new voicemail for you. To listen to your voicemail, dial an access number provided by your telephone service provider, followed by a security code or PIN.

Some telephone service providers bundle or combine multiple services like voicemail and call waiting, so you may not be aware that you have voicemail. To check what services you have and how to access them, contact your telephone service provider.

To use your voicemail service rather than the answering system, turn off the answering system. To use the answering system rather than your voicemail service, contact your telephone service provider to deactivate the voicemail service.

Use the answering machine and voicemail together

You can also use your telephone answering system and voicemail together by setting your built-in answering system to answer before voicemail answers, as described below. To learn how to program your voicemail settings, contact your telephone service provider. If you are on a call, or the answering system is busy recording a message and you receive another call, the second caller can leave a voicemail message.

Set the answering system to answer calls at least two rings earlier than your voicemail is set to answer. For example, if your voicemail answers after six rings, set the answering system to answer after four rings. Some voicemail providers may program the delay before answering calls in seconds instead of rings. In this case, allow six seconds per ring when determining the appropriate setting.

Message capacity

The answering system can record up to 99 messages, depending on the length of each message. Individual messages can be up to three minutes (see **Set recording time**), and the maximum recording time is approximately 22 minutes. The actual recording time depends on individual message characteristics. Messages remain available for replay until you delete them.

When there are new messages (including memos) on the answering system, the number of messages stored shows in the message counter.

If the answering system has less than three minutes of recording time left, it announces, "*Less than three minutes to record*," before message playback at the handset or the telephone base. **Rec mem low** displays on the device screen in idle mode. When you turn on the answering system at the telephone base, it announces, "*Calls will be answered. Less than three minutes to record*."

If the memory is full, the answering system announces, "*Memory is full*," before message playback. The device screen displays **Rec mem full** in idle mode. Once the memory is full, you cannot turn the answering system back on if it has been turned off, nor can you record new messages until old ones have been deleted. **Memory full** displays if you want to turn on the answering system on the handset but there is no memory.

Voice prompts

The system provides voice prompts to guide you through the setup procedures at the telephone base, message playback, remote access and recording outgoing announcements.

Call screening

To screen a call at the telephone base:

If the answering system and call screening are on (see **Turn the call screening on or off**), the announcement and the incoming message broadcast at the telephone base when a call is answered by the answering system.

Options while a message is being recorded:

- Press **+VOL -** on the telephone base to adjust the call screening volume.
- Press **PLAY/STOP** or **SILENCE** to temporarily silence the call screening.
- Press **PLAY/STOP** or **SCREEN** to temporarily turn on the call screening if call screening is set to off.
- Press **HOME** to answer the call.

To screen a call at the handset:

If the answering system is on and your answering system is recording a message, press **SCREEN** to screen the call on your handset and the screen displays the caller ID information. If you do not subscribe to caller ID service, the handset shows **Incoming call**.

Options while a message is being recorded:

- Press **▼ CID** or **▲** on the handset to adjust the call screening volume.
- Press **OFF/CANCEL** or **SILENCE** to temporarily silence the call screening.
- Press **SCREEN** to temporarily turn on the call screening if call screening is set to off.
- Press **📞** to turn off the speakerphone and screen the call through the handset earpiece.

Call intercept

While screening a call, you can stop recording and speak to the caller by pressing **HOME/FLASH** on the handset, or pressing **HOME** on the telephone base.

Temporarily turn off the message alert tone

If the message alert tone is turned on, the telephone base beeps every ten seconds when there are new messages. Pressing any telephone base key (except **FIND HS**) temporarily silences the message alert tone.

If you press **DELETE** when in idle mode to temporarily turn off the message alert tone, there is a voice prompt directing you to press **DELETE** again to delete all old messages. The message alert tone is temporarily off. Only press **DELETE** a second time if you wish to erase all old messages in your answering system.

The message alert tone resumes when you receive another message.

Message playback

If you have both new and old messages, you can play either new or old messages. The caller ID information displays on the screens when you play messages and you can call back the caller.

When playback begins, the handset screen and telephone base screen display the message status, caller ID information, and time and date of the message recorded. You hear the total number of messages followed by the day and time of the message. After the last message, the telephone announces, "End of messages." and the screen displays **End of messages**.

NOTE

- Make sure you set the date and time correctly. Refer to **Set date and time** under the **Configure your telephone** section for more details.

To listen to messages at the telephone base:

Press **PLAY/STOP** on the telephone base to listen to the messages.

- If there are new and old messages, press **▼ CID** or **▲** to select **Play new msgs** or **Play old msgs**, then press **SELECT** or **PLAY/STOP**.
- If there are only new or only old messages, they will play automatically.

When the handset is playing a message, its screen shows **[2]-Call info** and the caller's name or number. If the caller's information is unavailable, the handset shows **No caller info**.

The system announces the number of messages, then begins playback. The message sequence is shown on the telephone base. If there are no recorded messages, the telephone base shows **No messages** and you hear, "You have no message."

To listen to messages on a cordless handset:

1. When the handset is in idle mode, press **MENU** to enter the main menu.
2. Press **SELECT** to select **Play messages**.
 - If there are new and old messages, press **▼ CID** or **▲** to select **Play new msgs** or **Play old msgs**, then press **SELECT**.
 - If there are only new or only old messages, they will play automatically.

The system announces the number of messages, then begins playback. The message sequence is shown on the handset. If there are no recorded messages, the handset shows **No messages** and you hear, "You have no message."

Options during playback:

When a message is playing, you can adjust the playback volume, skip, repeat, pause or delete the message.

When messages are playing on the telephone base:

- Press **+ VOL -** to adjust the listening volume.
- Press **SKIP** or **SKIP** to skip to the next message.
- Press **REPEAT** or **REPEAT** to repeat the playing message. Press **REPEAT** or **REPEAT** twice to listen to the previous message.
- Press **DELETE** to delete the playing message. The telephone base announces, "Message deleted," and then advances to the next message.
- Press **2** to pause the playback and show the caller ID information.
 - Press **HOME** or **CALL** to use the home line, or press **CELL 1** or **CELL 2** to use the cell line to call back the caller. If necessary, press **#** (pound key) or **1** to show different dialing options.
 - Press **CANCEL** or **BACK** to restart the playback. If you do not call back within 10 seconds, message playback restarts.
- Press **PLAY/STOP** or **CANCEL** to stop the playback.

When messages are playing on the handset:

- Press **▼ CID** or **▲** to adjust the listening volume.
- Press **SKIP** to skip to the next message.
- Press **REPEAT** to repeat the playing message. Press **REPEAT** twice to listen to the previous message.
- Press **MUTE/DELETE** to delete the playing message.
- Press **2** to pause the playback and show the caller ID information.
 - Press **HOME/FLASH**, **CALL** or **📞** to use the home line, or press **CELL 1** or **CELL 2** to use the cell line to call back the caller. If necessary, press **#** (pound key) or **1** to show different dialing options.
 - Press **OFF/CANCEL** or **BACK** to restart the playback. If you do not call back within 10 seconds, message playback restarts.
- Press **OFF/CANCEL** to stop the playback.

NOTES

- Only one handset or the telephone base can access the answering system at a time.
- During message playback, if there is an incoming call or another handset makes a call, message playback will be stopped.

Delete all old messages

You can only delete old (reviewed) messages. You cannot delete new messages until you review them. You cannot retrieve deleted messages.

To delete all old messages with the telephone base:

1. When the telephone is idle, press **DELETE**. The system announces, "To delete all old messages, press **DELETE** again."
2. Press **DELETE** again. The system announces, "All old messages deleted!"

-OR-

1. Press **MENU** when in idle mode to enter the main menu.
2. Press **SELECT** to select **Answering sys**.
3. Press **▼ CID** or **▲** to highlight **Delete all old**, then press **SELECT**. The screen shows **Delete all old messages?**
4. Press **YES** to confirm. The screen displays **Deleting...** and then **All old msgs deleted!**. There is a confirmation tone.

To delete all old messages on the handset:

1. Press **MENU** when in idle mode to enter the main menu.
2. Press **▼ CID** or **▲** to scroll to **Answering sys**. Press **SELECT**.
3. Press **▼ CID** or **▲** to highlight **Delete all old**, then press **SELECT**. The screen shows **Delete all old messages?**
4. Press **YES** to confirm. The screen displays **Deleting...** and then **All old msgs deleted!**. There is a confirmation tone.

Record and play memos

Memos are your own recorded messages used as reminders for yourself or others using the same answering system. You can record your own memos using a system handset or the telephone base. Play and delete them in the same way as incoming messages.

Record a memo

Using a cordless handset:

1. When the telephone is in idle mode, press **MENU** to enter the main menu.
2. Press **▼ CID** or **▲** to scroll to **Answering sys**, then press **SELECT**.
3. Press **▼ CID** or **▲** to scroll to **Record memo**, then press **SELECT**. The system announces, "Record after the tone. Press STOP when you are done."
4. Speak towards the handset to record a memo.
5. Press **STOP** to stop recording. The system announces, "Recorded." and then returns to the previous menu.

Using the telephone base:

1. When the telephone is in idle mode, press **MENU** to enter the main menu.
2. Press **SELECT** to select **Answering sys**.
3. Press **▼ CID** or **▲** to scroll to **Record memo**, then press **SELECT**. The system announces, "Record after the tone. Press STOP when you are done."
4. Speak towards the telephone base to record a memo.
5. Press **STOP** to stop recording. The system announces, "Recorded." and then returns to the previous menu.

NOTES

- The system announces "Memory is full," if you attempt to record a memo when the memory is full.
- Each memo can be up to four minutes in length.
- Memos shorter than two seconds are not recorded.

Remote access

A two-digit security code is required to access the answering system remotely from any touch-tone telephone. The preset code is **19**. You can use this preset code, or set your own.

1. Dial your telephone number from any touch-tone telephone.
2. When the system plays your announcement, enter the two-digit security code.
3. Enter one of the following remote commands.

Command	Description
1	Play all messages.
2	Play only new messages.
3	Delete the current message (during playback).
33	Delete all old messages.
4	Repeat the current message (during playback).
5	Stop.
*5	Hear a list of remote commands.
6	Skip to the next message (during playback).
*7	Record a new announcement.
8	End the call.
0	Turn the answering system on or off.

4. Hang up or press **8** to end the call.

NOTES

- If you do not press any key after you enter the remote access code, all new messages play. If there are no new messages, all old messages play.
- Once the new messages have played, the telephone announces the help menu options. If you do not press any key within 20 seconds, the remote access call automatically disconnects.
- When the answering system is turned off, the telephone answers after 10 rings, and announces, "Please enter your remote access code."
- When the memory is full, the answering system answers incoming calls after 10 rings and announces, "Memory is full. Enter your remote access code."
- The telephone can respond to remote access code while it is playing the screening announcement or block announcement. This allows you to access your answering system from an unknown number remotely.

Set remote access code

To access your answering system remotely from any touch-tone phone, you need to enter a two-digit number (00-99).

To change the remote access code:

Using a cordless handset:

1. When the telephone is in idle mode, press **MENU** to enter the main menu.
2. Press **▼ CID** or **▲** to scroll to **Answering sys**, then press **SELECT**.
3. Press **▼ CID** or **▲** to scroll to **Ans sys setup**, then press **SELECT**.
4. Press **▼ CID** or **▲** to scroll to **Remote code**, then press **SELECT**.
5. Use the dialing keys to enter a two-digit number. Press **MUTE/DELETE** to backspace and delete a digit.
6. Press **SELECT** to save the setting. You hear a confirmation tone.

Using the telephone base:

1. When the telephone is in idle mode, press **MENU** to enter the main menu.
2. Press **SELECT** to select **Answering sys**.
3. Press **▼ CID** or **▲** to scroll to **Ans sys setup**, then press **SELECT**.
4. Press **▼ CID** or **▲** to scroll to **Remote code**, then press **SELECT**.
5. Use the dialing keys to enter a two-digit number. Press **DELETE** to backspace and delete a digit.
6. Press **SELECT** to save the setting. You hear a confirmation tone.

Record, play or delete memos

Memos are your own recorded messages used as reminders for yourself or others using the same answering system. You can record your own memos using a system handset. Playback and delete them in the same way as incoming messages.

1. Press **MENU** when the phone is not in use.
2. Press **▼** or **▲** to choose **Answering sys** and then press **SELECT**.
3. Press **▼** or **▲** to choose **Record memo** and then press **SELECT**. The handset displays **Record in 5 sec** (counting down) and then **Recording... Stop [5]** and announces, "Record after the tone. Press 5 when you are done."
4. Speak towards the handset microphone. Press **5** or **OFF** when you finish recording. The handset announces "Recorded."

NOTES

- If you record a memo when the answering system memory is full, the system announces, "Memory is full."
- Each memo can be up to three minutes in length. Memos shorter than two second are not recorded.
- When the answering system has less than three minutes of recording time left, the handset announces, "Less than three minutes to record," and displays **Rec mem low**.

Register a handset

When your handset is deregistered from the telephone base, follow the steps below to register it back to the telephone base.

Method 1:

1. Before you begin registration, make sure the handset is out of the telephone base or charger and shows **To register HS, see manual.**
2. Put the handset you wish to register on the telephone base cradle.
3. The handset shows **Registering... Please wait.** If the registration is successful, both the handset and the telephone base screens display **HANDSET X Registered (HANDSET** represents the handset name, **X** represents the handset number). Both the handset and the telephone base beep. The handset is now registered with the telephone base.

If registration fails, the system will automatically try to register again. If registration fails after the third try, **Registration failed** appears on both screens. The handset shows **To register HS, see manual.** and the telephone base returns to idle mode. This may take up to five minutes to occur. Please start again from Step 1.

Method 2:

1. Press and hold **FIND HS** on the telephone base for about four seconds and it shows **Registering... Please wait.**
2. Press **QUIET #** on the handset. The handset shows **Registering... Please wait.** If the registration is successful, both the handset and the telephone base screens display **HANDSET X Registered (HANDSET** represents the handset name, **X** represents the handset number). Both the handset and the telephone base beep. The handset is now registered with the telephone base.

If registration fails, **Registration failed** appears on both screens. The handset shows **To register HS, see manual.** and the telephone base returns to idle mode. This may take up to five minutes to occur. Please start again from Step 1.

Screen messages

Added to allow list	The telephone has just added an entry to the allow list.
Added to block list	The telephone has just added an entry to the block list.
Added to star name list	The telephone has just added an entry to the star name list.
Activating remote voice control...	The telephone is activating remote voice control.
BASE 0 is calling	The telephone base is calling.
BASE 0 is calling all	The telephone base is calling all devices (for intercom calls).
Block list is empty	There are no call block entries.
Blocked call	An incoming call was blocked.
Blocking call...	The Smart call blocker feature of the telephone is rejecting a call with block announcement.
Bluetooth system busy	You are trying to make a cell call or access the Bluetooth menu when the Bluetooth link is already being used.
Call transferred	You have transferred an outside call to another device.
Caller ID log empty	There are no entries in the caller ID log.
Calling BASE 0	The handset is calling the telephone base (for intercom calls).
Calling HANDSET X	The handset or telephone base is calling another handset (for intercom calls). The telephone base is transferring an outside call to a handset.
Cell	The cell line is on a call.
Cell call on hold	A call on the cell line has been put on hold.
Cell line in use	Another system handset is using the cell line.
Cell 1/2 alert: XXX	The Android phone that you paired with this telephone received a mobile notification.
Cell 1/2 low batt	Message received from Alerts manager that your cell phone's battery is low.
Connection failed	A Bluetooth device failed to establish a connection with your telephone system.
Connection timeout. Please check cell status.	The telephone has failed to activate remote voice control.
Contact deleted	A phonebook entry is deleted.

Phonebook empty	There are no phonebook entries.
Phonebook full	The phonebook is full. You cannot save any new entries unless you delete some current entries.
Downloading...	The system is downloading a directory from a cell phone.
Ended	You have just ended a call.
HANDSET X is calling	Another system handset is calling.
HANDSET X is calling all	The handset is calling all devices.
Home	The home line is on a call.
Home call on hold	A call on the home line has been put on hold.
Home & cell calls on hold	Calls on the home and cell lines have been put on hold.
Home & cell lines in use	Calls on the home and cell lines are being used.
Home line in use	A system handset or another telephone on the same home line is in use.
Incoming call	There is a call coming in.
Intercom	The device is on an intercom call.
Intercom ended	The intercom call has just ended.
Line in use	An extension phone, or one of the devices is in use.
Low battery	The battery is low. You should charge the battery.
Microphone ON	Mute is off so the other party can hear your voice.
Muted	The microphone is off. The other party cannot hear you.
New voicemail	There are new voicemail messages from your telephone service provider.
No answer. Try again.	The device(s) you are trying to transfer a call to is out of range, off hook, or has no power.
No battery	The handset in the charger has no battery installed.
No Bluetooth device is ready for connection	There is no Bluetooth device paired to the telephone system when you press CELL 1/CELL 2 on the telephone base or handset.
No caller info	The caller information is unavailable.
No home line	There is no telephone line connection.
No entries found. Download from SIM only ?	There are no entries found when you download a cell phone directory from the cell memory.

No entries found. Download from Phone only ?	There are no entries found when you download a cell phone directory from your SIM card. There are no entries found in either the cell or SIM card when you download a cell phone directory from both memories.
No messages	There are no messages in the answering system.
No PTT call	The incoming PTT function is turned off. The handset will not receive PTT calls.
No signal. Call ended.	The phone lost connection with the telephone base or did not have a strong enough signal and the phone call ended.
Not available at this time	Someone else is already using the phonebook or caller ID log. When a handset tries to access the answering system or Bluetooth menu during battery backup mode.
Number already saved	The telephone number you have entered is already in the phonebook, allow list or block list..
Out of range OR no power at base	The telephone base has lost power, or the handset is out of range.
** Paging **	The cordless handset is paged by the telephone base.
Paging all devices	The telephone base is paging all devices.
Place in charger	The battery is very low. The handset should be charged.
PTT From HANDSET X To devices: X	One handset has started a PTT session to another handset and telephone base.
PTT From HANDSET X To devices: X	One handset has started a PTT session to another handset.
PTT To HANDSET X	You have started the PTT process with a handset.
PTT To BASE 0	You have started the PTT process with the telephone base.
Push to talk Ended	The PTT session is ended.
Quiet mode on	QUIET mode is on.
Quiet mode is off	QUIET mode is turned off.
Rec mem full	The system recording time is full.
Rec mem low	The system recording time is low.
Registering... Please wait	The handset is registering to the telephone base.
Registration slots are full	The telephone base has the maximum of 12 handsets registered to it.
Registration failed	The handset registration is not successful.

Remote voice control ended.	The remote voice control operation is ended.
Ringer off	The ringer is turned off.
Ringer muted	The ringer is off temporarily while the device is ringing.
Saved to phonebook	An entry has been successfully saved in the phonebook.
Screened call	The Smart call blocker feature of the telephone has screened a call and is putting the call through to you.
Setting up Answering system...	The telephone is playing voice guide.
Smart call blk screening...	The Smart call blocker feature of the telephone is screening a call and playing the screening announcement to the caller.
To register HS, see manual.	Screen display before handset registration.
Unable to call. Try again	You try to join a call when there are already four handsets on that call. You try to make an outside call when another device is transferring a call with the intercom feature.
Start voice guide to set up Smart call blocker now?	After you install your telephone or power returns following a power outage, the telephone will prompt you to set the date and time. After the date and time setting is done or skipped, the telephone will then prompt if you want to set up the Smart call blocker feature via voice guide.
XX Missed calls	There are new calls in the caller ID log.
XX New msgs	Displays on handset screen when you have new messages in the answering system.
XX New messages	Displays on telephone base screen when you have new messages in the answering system.

General product care

Taking care of your telephone

Your cordless telephone contains sophisticated electronic parts, so it must be treated with care.

Avoid rough treatment

Place the handset down gently. Save the original packing materials to protect your telephone if you ever need to ship it.

Avoid water

Your telephone can be damaged if it gets wet. Do not use the handset outdoors in the rain, or handle it with wet hands. Do not install the telephone base near a sink, bathtub or shower.

Electrical storms

Electrical storms can sometimes cause power surges harmful to electronic equipment. For your own safety, take caution when using electrical appliances during storms.

Cleaning your telephone

Your telephone has a durable plastic casing that should retain its luster for many years. Clean it only with a dry non-abrasive cloth. Do not use dampened cloth or cleaning solvents of any kind.

Frequently asked questions

Below are the questions most frequently asked about the cordless telephone. If you cannot find the answer to your question, visit our website at

www.vtechphones.com or call

1 (800) 595-9511 for customer service. In Canada, go to phones.vtechcanada.com or call **1 (800) 267-7377**.

I cannot pair my cell phone to the telephone base.	<ul style="list-style-type: none"> Make sure you have cellular coverage. Make sure your cell phone is compatible with your telephone system. Check the Bluetooth compatibility list at www.vtechphones.com or phone.vtechcanada.com. Make sure the Bluetooth function of your cell phone is turned on. See the user's manual of your cell phone for more information. Make sure that you set your cell phone to search for devices. If the telephone systems in your cell phone device history list, delete it and try pairing again. Carefully follow the pairing instructions in Add a cell phone section and make sure that your cell phone is not connected to any other Bluetooth device. Turn off your cell phone, then turn it on again. Reset the telephone base. Unplug the unit's electrical power. Wait for approximately 15 seconds, then plug it back in. Repeat the suggestions mentioned above.
I cannot pair my headset to the telephone base.	<ul style="list-style-type: none"> Make sure that your Bluetooth headset is in discoverable mode when pairing with the telephone base. See the user's manual of your headset for more information on how to set your headset to discoverable mode. Make sure your headset is compatible with your telephone system. Check the Bluetooth compatibility list at www.vtechphones.com or phone.vtechcanada.com. Carefully follow the pairing instructions in Add a headset section and make sure that your headset is not connected to any other Bluetooth device. Reset the telephone base. Unplug the unit's electrical power. Wait for approximately 15 seconds, then plug it back in. Repeat the suggestions mentioned above.
I cannot connect my cell phone with the telephone base.	<ul style="list-style-type: none"> Make sure that the Bluetooth function of your cell phone is turned on. See the user's manual of your cell phone for more information. Make sure that your Bluetooth cell phone is not connected to any other Bluetooth device. Turn off your cell phone, then turn it on again. Make sure that your cell phone is on the active devices list. For some cell phones, you must authorize the IS8151/IS8251 device in your cell phone's Bluetooth feature. See the user's manual of your cell phone for more information. Manually connect your cell phone to your telephone system. Refer to the user's manual of your cell phone for more information.

I cannot connect my headset with the telephone base.	<ul style="list-style-type: none"> Make sure that your Bluetooth headset is not connected to any other Bluetooth device. Make sure that your headset is on the active devices list.
I cannot put my headset in discoverable mode.	<ul style="list-style-type: none"> Refer to the user's manual of your headset for information on how to set your headset to discoverable mode. Make sure that the headset is not connected to any other Bluetooth device in order to successfully pair and connect to the telephone base. Carefully follow the pairing process in the Add a headset section. Reset the telephone base. Unplug the unit's electrical power. Wait for approximately 15 seconds, then plug it back in. Repeat the suggestions mentioned above.
I don't know how to search for or add new devices on my cell phone.	<ul style="list-style-type: none"> Most cell phones have the Bluetooth feature in the connection or setup menus. Please refer to the user's manual of your cell phone. In general, press the menu key on your cell phone, then look for the Bluetooth menu in the settings or connection menu. In the Bluetooth menu, select the option to search for or add new devices.
My cell phone disconnects with the telephone base.	<ul style="list-style-type: none"> Turn off your cell phone, then turn it on again. Make sure that you are not using your cell phone when on a cell call.
My cell phone is connected to the telephone base, but I cannot make a cell call.	<ul style="list-style-type: none"> Make sure that your cell phone is not in use when you are trying to make a cell call. For some smartphones, make sure that the cellular function is turned on.
Bluetooth system busy appears on the display.	<ul style="list-style-type: none"> Make sure that your cell phone is not in use when connected and on the active devices list. Make sure that your cell phone or headset is not connected to any other Bluetooth device. Your telephone system can only use one Bluetooth device at a time.
I cannot hear any audio on my telephone system when on a cell call.	<ul style="list-style-type: none"> Make sure that your cell phone's volume is not too low or muted. Reset the telephone base. Unplug the unit's electrical power. Wait for approximately 15 seconds, then plug it back in. Turn off your cell phone, then turn it on again.
The listening volume of my cell call is too loud or quiet.	<ul style="list-style-type: none"> During a cell call, if the listening volume is too loud or quiet, try changing the volume on your cell phone. On some cell phones, changing the volume on the cell phone effects your cell call volume on the IS8151/IS8251.
I cannot download contacts from my cell phone to my IS8151/IS8251.	<ul style="list-style-type: none"> Make sure that your cell phone is paired and connected to the base. Make sure you place your cell phone next to the base while downloading. If your cell phone does not support the download, you can send the directory from your cell phone. The system can receive the directory automatically. See the user's manual of your cell phone for more information.

I see duplicate entries in my downloaded directory.	<ul style="list-style-type: none"> If you see duplicate directory entries, you can delete them manually. Another option is to download again either your SIM card or phone memory, but not both.
Some of my cell phone contacts were not imported to my IS8151/IS8251.	<ul style="list-style-type: none"> Try copying the contacts from your SIM card to your cell phone memory first, then download from your phone memory. If that doesn't work, try copying the contacts from your cell phone memory to your SIM card, then download from your SIM card. For more information on how to transfer contacts between your SIM card and your phone memory, refer to the user's manual of your cell phone.
Can the IS8151/IS8251 help the poor cell phone reception in my house?	<ul style="list-style-type: none"> If your cell phone has poor reception in your home, the IS8151/IS8251 cannot improve the reception. However, if you have a location in your house with better reception, you can leave your cell phone in that location while you use IS8151/IS8251 cell line. In order for this to work, the cell phone must be within 15 feet of the telephone base for optimal performance.
My telephone does not work at all.	Make sure the telephone base is installed properly, and battery is installed and charged correctly. For optimum daily performance, return the handset to the telephone base after use.
The display shows No home line. I cannot hear the dial tone.	<p>Disconnect the telephone line cord from your telephone and connect it to another telephone. If there is no dial tone on that other telephone either, then the telephone line cord may be defective. Try installing a new telephone line cord.</p> <p>If changing the telephone line cord does not help, the wall jack (or the wiring to this wall jack) may be defective. Contact your telephone service provider.</p> <p>You may be using a new cable or VoIP service, the existing telephone jacks in your home may no longer work. Contact your service provider for solutions.</p>
I cannot dial out.	<p>Make sure there is a dial tone before dialing. It is normal if the handset takes a second or two to synchronize with the telephone base before producing a dial tone. Wait an extra second before dialing.</p> <p>Eliminate any background noise. Mute the handset before dialing, or dial from another room in your home with less background noise.</p>
The display shows To register HS, See manual. The handset does not work at all.	The handset is deregistered from the telephone base. Follow the steps in Register a handset to register the handset back to the telephone base.
The display shows Low battery.	Place the handset in the telephone base or charger for charging.
The battery does not charge in the handset or the handset battery does not accept charge.	<p>Make sure the handset is placed in the telephone base or charger correctly.</p> <p>If the battery is completely depleted, charge the battery for at least 30 minutes before use.</p> <p>You may need to purchase a new battery.</p>
The telephone does not ring when there is an incoming call.	<p>Make sure the ringer volume is not set to off.</p> <p>The handset may be too far from the telephone base. Move it closer to the telephone base.</p>

My handset beeps and is not performing normally.	Move the handset closer to the telephone base. It may be out of range.
I hear noise on the cordless handset and the keys do not work.	Make sure the telephone line cord is plugged in securely.
I hear other calls when using the telephone.	Disconnect the telephone base from the telephone wall jack. Plug in a different telephone. If you still hear other calls, the problem is probably in the wiring or telephone service. Contact your telephone service provider.
There is interference during a telephone conversation. My calls fade out when I am using the cordless handset.	<p>The handset may be out of range. Move it closer to the telephone base.</p> <p>If you subscribe to high-speed Internet service (DSL - digital subscriber line) through your telephone line, you must install a DSL filter between the telephone line cord and the telephone wall jack. The filter prevents noise and caller ID problems caused by DSL interference. Contact your DSL service provider for more information about DSL filters.</p> <p>Appliances or other cordless telephones plugged into the same circuit as the telephone base can cause interference. Try moving the appliance or telephone base to another outlet.</p> <p>The location of your telephone base can impact the performance of your cordless phone. For better reception, install the telephone base in a centralized location within your home or office, away from walls or other obstructions. In many environments, elevating the telephone base improves overall performance.</p>
The telephone does not receive caller ID or the telephone does not show caller ID during call waiting.	<p>Caller ID is a subscription service. You must subscribe to this service from your telephone service provider for this feature to work on your telephone.</p> <p>Both your and the caller's telephone service providers must use equipment compatible with the caller ID service.</p> <p>The caller may not be calling from an area which supports caller ID.</p> <p>The caller ID information displays after the first or second ring.</p>
The display shows Out of range or no pwr at base.	<p>The handset may be out of range. Move it closer to the telephone base.</p> <p>Make sure the power cord is securely plugged into the telephone base. Use a working electrical outlet not controlled by a wall switch.</p>
I cannot hear any instruction from the handset when I try to record, play or delete my own announcement.	The handset does not have a speakerphone. When recording, playing or deleting your own announcement, the instructions are announced through the handset receiver. Make sure you place the handset receiver close to your ear.
The outgoing announcement is not clear.	<p>When recording the announcement, make sure you speak in a normal tone of voice towards the microphone of the handset.</p> <p>Make sure there is no background noise when recording.</p>

The answering system does not record messages.	<p>Make sure the answering system is on. When the answering system is on, ANS ON should display on the handset and the telephone base.</p> <p>When the answering machine memory is full, it does not record new messages until some old messages are deleted.</p> <p>If you subscribe to voicemail service, change the number of rings so that your answering system answers before your voicemail service answers. To determine how many rings activate your voicemail service, contact your telephone service provider.</p>
The messages on the answering system are very difficult to hear.	Press VOL+ on the telephone base or VOLA on the handset to increase the listening volume.
The answering system does not announce the correct day of the week for recorded messages time stamp.	Make sure you have set the date and time. See Configure your telephone section.
The messages on the answering system are incomplete.	<p>If a caller leaves a very long message, part of it may be lost when the answering system disconnects the call after the preset recording time.</p> <p>If the memory on the answering system becomes full during a message, the answering system stops recording and disconnects the call.</p> <p>If the caller's voice is very soft, the answering system may stop recording and disconnect the call.</p>
The answering system does not respond to remote commands.	<p>Make sure you enter the correct remote access code.</p> <p>Make sure you are calling from a touch-tone telephone. When dialing a number, there should be tones. If there are clicks, then it is not a touch-tone telephone and cannot activate the answering system.</p> <p>The answering system may not detect the remote access code when your announcement is playing. Wait until the announcement is over before entering the code.</p>
I subscribe to a nontraditional telephone service that uses my computer to establish connections, and my telephone doesn't work.	<p>Make sure your computer is powered on, and your Internet is working properly.</p> <p>Make sure to plug your USB telephone adapter into a dedicated USB port on your computer. Do not plug into a multiple port USB hub (USB splitter) that is not powered.</p> <p>In a few rare instances, the USB port on your computer may not have enough power. In these instances, try using a USB hub with its own external power supply.</p> <p>If you are using a firewall, it may prevent access to your nontraditional telephone service. Contact your service provider for more information.</p>
I accidentally set my LCD language to Spanish or French, and I don't know how to change it back to English.	While the handset is not in use, press MENU and then enter 364# to change the handset LCD language back to English.

The RBRC seal

The RBRC seal on the nickel-metal hydride battery indicates that VTech Communications, Inc. is voluntarily participating in an industry program to collect and recycle these batteries at the end of their useful lives, when taken out of service within the United States and Canada.

The program provides a convenient alternative to placing used nickel-metal hydride batteries into the trash or municipal waste, which may be illegal in your area.

VTech's participation makes it easy for you to drop off the spent battery at local retailers participating in the program or at authorized VTech product service centers. Please call **1 (800) 8 BATTERY®** for information on Ni-MH battery recycling and disposal bans/restrictions in your area. VTech's involvement in this program is part of its commitment to protecting our environment and conserving natural resources.

The RBRC seal and 1 (800) 8 BATTERY® are registered trademarks of Call2recycle, Inc.



FCC, ACTA and IC regulations

FCC Part 15

NOTE: This equipment has been tested and found to comply with the requirements for a Class B digital device under Part 15 of the Federal Communications Commission (FCC) rules. These requirements are intended to provide reasonable protection against harmful interference in a residential installation. This equipment generates, uses and can radiate radio frequency energy and, if not installed and used in accordance with the instructions, may cause harmful interference to radio communications. However, there is no guarantee that interference will not occur in a particular installation. If this equipment does cause harmful interference to radio or television reception, which can be determined by turning the equipment off and on, the user is encouraged to try to correct the interference by one or more of the following measures:

- Reorient or relocate the receiving antenna.
- Increase the separation between the equipment and receiver.
- Connect the equipment into an outlet on a circuit different from that to which the receiver is connected.
- Consult the dealer or an experienced radio/TV technician for help.

WARNING: Changes or modifications to this equipment not expressly approved by the party responsible for compliance could void the user's authority to operate the equipment.

This device complies with Part 15 of the FCC rules. Operation is subject to the following two conditions: (1) this device may not cause harmful interference, and (2) this device must accept any interference received, including interference that may cause undesired operation. Privacy of communications may not be ensured when using this telephone.

To ensure safety of users, the FCC has established criteria for the amount of radio frequency energy that can be safely absorbed by a user or bystander according to the intended usage of the product. This product has been tested and found to comply with the FCC criteria. The handset may be safely held against the ear of the user. The telephone base shall be installed and used such that parts of the user's body other than the hands are maintained at a distance of approximately 20 cm (8 inches) or more.

This Class B digital apparatus complies with Canadian requirement:
CAN ICES-3 (B)/NMB-3(B).

FCC Part 68 and ACTA

This equipment complies with Part 68 of the FCC rules and with technical requirements adopted by the Administrative Council for Terminal Attachments (ACTA). The label on the back or bottom of this equipment contains, among other things, a product identifier in the format US:AAAEQ##TXXXX. This identifier must be provided to your telephone service provider upon request.

The plug and jack used to connect this equipment to premises wiring and the telephone network must comply with applicable Part 68 rules and technical requirements adopted by ACTA. A compliant telephone cord and modular plug is

provided with this product. It is designed to be connected to a compatible modular jack that is also compliant. An RJ11 jack should normally be used for connecting to a single line and an RJ14 jack for two lines. See the installation instructions in the user's manual.

The Ringer Equivalence Number (REN) is used to determine how many devices you may connect to your telephone line and still have them ring when you are called. The REN for this product is encoded as the 6th and 7th characters following the US: in the product identifier (e.g., if ## is 03, the REN is 0.3). In most, but not all areas, the sum of all RENs should be five (5.0) or less. For more information, please contact your telephone service provider.

This equipment may not be used with Party Lines. If you have specially wired alarm dialing equipment connected to your telephone line, ensure the connection of this equipment does not disable your alarm equipment. If you have questions about what will disable alarm equipment, consult your telephone service provider or a qualified installer.

If this equipment is malfunctioning, it must be unplugged from the modular jack until the problem has been corrected. Replacement to this telephone equipment can only be made by the manufacturer or its authorized agents. For replacement procedures, follow the instructions outlined under the Limited warranty.

If this equipment is causing harm to the telephone network, the telephone service provider may temporarily discontinue your telephone service. The telephone service provider is required to notify you before interrupting service. If advance notice is not practical, you will be notified as soon as possible. You will be given the opportunity to correct the problem and the telephone service provider is required to inform you of your right to file a complaint with the FCC. Your telephone service provider may make changes in its facilities, equipment, operation, or procedures that could affect the proper functioning of this product. The telephone service provider is required to notify you if such changes are planned.

If this product is equipped with a corded or cordless handset, it is hearing aid compatible.

If this product has memory dialing locations, you may choose to store emergency telephone numbers (e.g., police, fire, medical) in these locations. If you do store or test emergency numbers, please:

Remain on the line and briefly explain the reason for the call before hanging up.

Perform such activities in off-peak hours, such as early morning or late evening.

Industry Canada

This device contains licence-exempt transmitter(s)/receiver(s) that comply with Innovation, Science and Economic Development Canada's licence-exempt RSS(s). Operation is subject to the following two conditions:

(1) This device may not cause interference.

(2) This device must accept any interference, including interference that may cause undesired operation of the device.

Privacy of communications may not be ensured when using this telephone.

The term "IC:" before the certification/registration number only signifies that the Industry Canada technical specifications were met.

The Ringer Equivalence Number (REN) for this terminal equipment is 1.0. The REN indicates the maximum number of devices allowed to be connected to a telephone interface. The termination on an interface may consist of any combination of devices subject only to the requirement that the sum of the RENs of all the devices not exceed five.

This product meets the applicable Innovation, Science and Economic Development Canada technical specifications.

California Energy Commission battery charging testing instructions

This telephone is set up to comply with the energy-conserving standards right out of the box. These instructions are intended for California Energy Commission (CEC) compliance testing only. When the CEC battery charging testing mode is activated, all telephone functions, except battery charging, will be disabled.

To activate the CEC battery charging testing mode:

1. Unplug the telephone base power adapter from the power outlet. Make sure all handsets are plugged with charged batteries before proceeding.
2. While you press and hold **FIND HS**, plug the telephone base power adapter back to the power outlet.
3. After about 20 seconds, when the **HOME** light starts flashing, release **FIND HS** and then press it again within two seconds. You hear a confirmation tone. The **HOME** light turns off and all handsets display **To register HS, see manual.** Allow up to one minute for the process to complete.

NOTE

- When the phone fails to enter this mode, repeat Step 1 through Step 3 above.

To deactivate the CEC battery charging testing mode:

1. Unplug the telephone base power adapter from the power outlet, then plug it back in. Then the telephone base is powered up as normal.
2. Register your handsets back to the telephone base. Refer to **Register a handset.**



For C-UL compliance only

Mesures de sécurité importantes

Afin de réduire les risques d'incendie, de blessures corporelles ou d'électrocution, suivez toujours ces mesures préventives de base lorsque vous utilisez votre téléphone :

1. Lisez et comprenez bien toutes les instructions.
2. Observez toutes les instructions et mises en garde inscrites sur l'appareil.
3. Débranchez ce téléphone de la prise murale avant de le nettoyer. N'utilisez pas de nettoyeurs liquides ni en aérosol. N'utilisez qu'un chiffon doux et légèrement humecté.
4. **ATTENTION:** Ne pas installer le socle téléphonique à une hauteur supérieure à 2 mètres.
5. N'utilisez pas ce produit près de l'eau, tel que près d'un bain, d'un lavabo, d'un évier de cuisine, d'un bac de lavage ou d'une piscine, ou dans un sous-sol humide ou sous la douche.
6. Ne déposez pas ce téléphone sur un chariot, support ou table chancelants. L'appareil pourrait tomber et être sérieusement endommagé.
7. Évitez d'installer le système téléphonique dans les endroits soumis à une température extrême, à la lumière directe du soleil ou à proximité immédiate d'autres appareils électriques ou électroniques. Protégez votre téléphone contre les sources d'humidité, la poussière, les vapeurs et les liquides corrosifs.
8. Le boîtier de l'appareil est doté de fentes et d'ouvertures d'aération situées à l'arrière ou en dessous. Afin d'empêcher la surchauffe, ces ouvertures ne doivent pas être obstruées en plaçant l'appareil sur un lit, divan, tapis ou autre surface similaires. Ne placez pas cet appareil à proximité d'un élément de chauffage ni d'une plinthe électrique. De plus, ne l'installez pas dans une unité murale ou un cabinet fermé qui ne possède pas d'aération adéquate.
9. Ne faites fonctionner cet appareil qu'avec le type d'alimentation indiqué sur les étiquettes de l'appareil. Si vous ne connaissez pas le voltage de votre maison, consultez votre marchand ou votre fournisseur d'électricité.
10. Ne déposez rien sur le cordon d'alimentation. Installez cet appareil dans un endroit sécuritaire, là où personne ne pourra trébucher sur la ligne d'alimentation ni le cordon téléphonique modulaire.
11. N'insérez jamais d'objets à travers les fentes et ouvertures de cet appareil, car ils pourraient toucher à des points de tension dangereux ou court-circuiter des pièces, ce qui constituerait un risque d'incendie ou d'électrocution. N'échappez pas de liquides dans l'appareil.
12. Afin de réduire les risques d'électrocution, ne démontez pas l'appareil, mais apportez-le plutôt à un centre de service qualifié s'il doit être réparé. En enlevant le couvercle, vous vous exposez à des tensions dangereuses ou autres dangers similaires. Un remontage inadéquat peut être à l'origine d'une électrocution lors d'une utilisation ultérieure de l'appareil. Débranchez l'appareil avant de procéder au nettoyage. Utilisez un chiffon humide et doux.
13. Ne surchargez pas les prises de courant et les rallonges.
14. Débranchez cet appareil de la prise de courant et

communiquez avec le département de service à la clientèle de VTech dans les cas suivants :

- Lorsque le cordon d'alimentation est endommagé ou écorché.
 - Si du liquide a été échappé dans l'appareil.
 - Si l'appareil a été exposé à une source d'humidité telle que la pluie ou l'eau.
 - Si le produit ne fonctionne pas normalement en respectant les instructions de fonctionnement. Réglez uniquement les commandes indiquées dans le les instructions de fonctionnement. Les réglages incorrects des autres commandes pourraient provoquer un dommage qui pourrait exiger un travail exhaustif de la part d'un technicien autorisé afin de rétablir le fonctionnement normal de l'appareil.
 - Si le produit a été échappé et que le socle et/ou le combiné a été endommagé.
 - Si le produit affiche une nette diminution de sa performance.
15. Évitez d'utiliser un téléphone (autre qu'un sans fil) pendant un orage. Les éclairs peuvent être à l'origine d'une électrocution.
 16. N'utilisez pas le téléphone pour rapporter une fuite de gaz à proximité de la fuite. En certaines circonstances, une flammèche pourrait être provoquée lorsque l'adaptateur est branché à une prise de courant, ou lorsque le combiné est déposé sur le socle. Ceci est un événement commun associé à la fermeture d'un circuit électrique. L'utilisateur ne devrait pas brancher le téléphone à une prise de courant, et ne devrait pas déposer le combiné chargé sur le socle, si le téléphone se trouve à proximité d'un endroit comportant des concentrations de gaz inflammables, à moins que la ventilation soit adéquate. Une flammèche dans un tel endroit pourrait provoquer un incendie ou une explosion. De tels environnements peuvent comprendre: des endroits où l'on utilise de l'oxygène médical sans ventilation adéquate; des gaz industriels (dissolvants de nettoyage, des vapeurs d'essence, etc.); une fuite de gaz naturel, etc.
 17. Ne placez que le combiné de votre téléphone près de votre oreille lorsqu'en mode de conversation.
 18. Ces adaptateurs ont été conçus pour être orientés en position verticale ou montés au sol. Les broches ne sont pas conçues pour maintenir l'adaptateur en place si celui-ci est branché dans une prise au plafond ou sous une table/ armoire.
 19. Pour le MATERIEL RACCORDE PAR PRISE DE COURANT, le socle de prise de courant doit être installé à proximité du matériel et doit être aisément accessible.
 20.   **MISE EN GARDE:** Il peut y avoir un risque d'explosion si vous utilisez le mauvais type de piles pour le téléphone. N'utilisez que les piles rechargeable inclus ou les piles de rechange (BT183342/BT283342). N'incinerez pas les piles. Celles-ci risqueraient d'exploser.
 21. N'utilisez que les adaptateurs inclus avec ce produit. L'utilisation d'un adaptateur dont la polarité ou la tension serait inadéquate risque d'endommager sérieusement le produit et mettre votre sécurité en péril.

CONSERVEZ CES INSTRUCTIONS

Pile

- MISE EN GARDE : N'utilisez que la pile incluse.
- Ne jetez pas la pile au feu. Vérifiez les instructions spécifiques de mise aux rebus auprès des autorités locales.
- N'ouvrez pas et ne mutilez pas la pile. L'électrolyte qui s'en échapperait est corrosif et pourrait causer des brûlures ou des blessures aux yeux ou à la peau. L'électrolyte est toxique si avalé.
- Soyez prudents lorsque vous manipulez les piles afin d'éviter les courts-circuits provoqués par des matériaux conducteurs.
- Rechargez la pile incluse avec cet appareil, selon les instructions et limites spécifiées dans ce guide d'utilisation.

Stimulateurs cardiaques implantés dans l'organisme

Les simulateurs cardiaques (s'applique uniquement aux téléphones numériques sans fil) :

L'organisme 'Wireless Technology Research, LLC (WTR)', une firme de recherche indépendante, a mené une évaluation pluridisciplinaire des interférences entre les téléphones sans fil portatifs et les stimulateurs cardiaques implantés dans l'organisme. Appuyée par l'Administration des aliments et drogues (FDA) des États-Unis, la firme WTR recommande aux médecins :

Avis aux détenteurs de stimulateurs cardiaques

- Ils doivent tenir le téléphone sans fil à une distance d'au moins six pouces du stimulateur cardiaque.
- Ils ne doivent PAS placer le téléphone sans fil directement sur le stimulateur cardiaque, tel que dans une poche de chemise, lorsque celui-ci est en marche.
- Ils doivent utiliser le téléphone sans fil en l'appuyant sur l'oreille qui se trouve dans la direction opposée au stimulateur cardiaque.

L'étude effectuée par l'organisme WRS n'a pas identifié de risque pour les détenteurs de simulateurs cardiaques causés par les gens qui utilisent un téléphone sans fil à proximité de ceux-ci.

À propos des téléphones sans fil

- **Confidentialité :** Les mêmes caractéristiques qui constituent des avantages pour les téléphones sans fil affichent également des restrictions. Les appels téléphoniques sont transmis entre le combiné sans fil et le socle par le biais d'ondes radio ; il y a donc la possibilité que vos conversations téléphoniques sans fil soient interceptées par des équipements de réception radio se trouvant dans la portée du combiné sans fil. Pour cette raison, vous ne devez pas percevoir les communications téléphoniques sans fil comme étant aussi confidentielles que celles des téléphones à cordons.
- **Alimentation électrique :** Le socle de ce téléphone sans fil doit être branché à une prise électrique fonctionnelle. La prise électrique ne doit pas être contrôlée par un

interrupteur mural. Les appels ne pourront pas être effectués du combiné sans fil si le socle est débranché ou mis hors tension ou si le courant est coupé.

- **Possibilité d'interférences aux téléviseurs :** Certains téléphones sans fil fonctionnent sur des fréquences pouvant causer des interférences aux téléviseurs et aux magnétoscopes. Pour réduire ou prévenir de telles interférences, ne placez pas le socle du téléphone sans fil près ou sur un téléviseur ou magnétoscope. S'il y a présence de parasites, il est conseillé d'éloigner le téléphone sans fil du téléviseur ou du magnétoscope afin de réduire possiblement les interférences.
- **Piles rechargeables :** Manipulez les piles avec soin afin de ne pas les court-circuiter avec des bagues, bracelets ou clés. Les piles ou le conducteur peut surchauffer et causer des blessures. Respectez la polarité adéquate entre la pile et le chargeur.
- **Les bloc-piles rechargeables à l'hydrure métallique de nickel :** Jetez ces blocs-piles de manière écologique et sécuritaire. Ne les incinerez pas et ne les percez pas. Tel que les autres piles de ce type, elles pourraient dégager une matière toxique qui peut causer des blessures corporelles si elles sont brûlées ou percées.

Limited warranty

What does this limited warranty cover?

The manufacturer of this VTech product, VTech Communications, Inc. ("VTech"), warrants to the holder of a valid proof of purchase ("Consumer" or "you") that the Product and all accessories provided by VTech in sales package ("Product") are free from material defects in material and workmanship, pursuant to the following terms and conditions, when installed and used normally and in accordance with operating instructions. This limited warranty extends only to the Consumer for Products purchased and used in the United States of America and Canada.

What will VTech Communications do if the Product is not free from material defects in materials and workmanship during the limited warranty period ("Materially Defective Product")?

During the limited warranty period, VTech's authorized service representative will replace at VTech's option, without charge, a Materially Defective Product. If we choose to replace the Product, we may replace it with a new or refurbished Product of the same or similar design. VTech will return replacement products to you in working condition. VTech will retain defective parts, modules, or equipment. Replacement of the Product, at VTech's option, is your exclusive remedy. You should expect the replacement to take approximately 30 days.

How long is the limited warranty period?

The limited warranty period for the product extends for ONE (1) YEAR from date of purchase (90 days on products purchased as Refurbished*). This limited warranty also applies to replacement Products for a period of either (a) 90 days from the date the replacement Product is shipped to you or (b) the time remaining on the original one-year limited warranty (90-day limited warranty on products that are purchased as Refurbished*). Whichever is longer.

*Refurbished products purchased from our online store carry a 90-day replacement warranty.

What is not covered by this limited warranty?

This limited warranty does not cover:

1. Product that has been subjected to misuse, accident, shipping or other physical damage, improper installation, abnormal operation or handling, neglect, inundation, fire, water or other liquid intrusion; or
2. Product that has been damaged due to repair, alteration or modification by anyone other than an authorized service representative of VTech; or
3. Product to the extent that the problem experienced is caused by signal conditions, network reliability, or cable or antenna systems; or
4. Product to the extent that the problem is caused by use with non-VTech electrical accessories; or
5. Product whose warranty/quality stickers, product serial number plates or electronic serial numbers have been removed, altered or rendered illegible; or
6. Product purchased, used, serviced, or shipped for repair from outside the United States, or used for commercial or institutional purposes (including but not limited to Products used for rental purposes); or
7. Product returned without valid proof of purchase (see 2 below); or

8. Charges for installation or set up, adjustment of customer controls, and installation or repair of systems outside the unit.

How do you get warranty service?

To obtain warranty service in the United States of America, please visit our website at www.vtechphones.com or call 1 (800) 595-9511 for instructions regarding where to return the Product. In Canada, go to phones.vtechcanada.com or dial 1 (800) 267-7377.

NOTE: Before calling for service, please review the user's manual - a check of the Product's controls and features may save you a service call.

Except as provided by applicable law, you assume the risk of loss or damage during transit and transportation and are responsible for delivery or handling charges incurred in the transport of Product(s) to the service location. VTech will return replaced product under this limited warranty to you, transportation, delivery or handling charges prepaid. VTech assumes no risk for damage or loss of the Product in transit.

What must you return with the Product to get warranty service?

1. Return the entire original package and contents including the Product to the VTech service location along with a description of the malfunction or difficulty;
2. Include "valid proof of purchase" (sales receipt) identifying the Product purchased (Product model) and the date of purchase or receipt; and
3. Provide your name, complete and correct mailing address, and telephone number.

Other limitations

This warranty is the complete and exclusive agreement between you and VTech. It supersedes all other written or oral communications related to this Product. VTech provides no other warranties for this Product. The warranty exclusively describes all of VTech's responsibilities regarding the Product.

There are no other express warranties. No one is authorized to make modifications to this warranty and you should not rely on any such modification.

State Law Rights: This warranty gives you specific legal rights, and you also have other rights which vary from state to state.

Limitations: Implied warranties, including those of fitness for a particular purpose and merchantability (an unwritten warranty that the Product is fit for ordinary use) are limited to one year from date of purchase. Some states do not allow limitations on how long an implied warranty lasts, so the above limitation may not apply to you.

In no event shall VTech be liable for any indirect, special, incidental, consequential, or similar damages (including, but not limited to lost profits or revenue, inability to use the product, or other associated equipment, the cost of substitute equipment, and claims by third parties) resulting from the use of this product. Some states do not allow the exclusion or limitation of incidental or consequential damages, so the above limitation or exclusion may not apply to you.

Please retain your original sales receipt as proof of purchase.

Disclaimer and Limitation of Liability

VTech Communications, Inc. and its suppliers assume no responsibility for any damage or loss resulting from the use of this user's manual. VTech Communications, Inc. and its suppliers assume no responsibility for any loss or claims by third parties that may arise through the use of this product.

Company: VTech Communications, Inc.

Address: 9020 SW Washington Square Road - Ste 555 Tigard, OR 97223, United States

Phone: 1 (800) 595-9511 in the U.S. or 1 (800) 267-7377 in Canada

Technical specifications

Frequency control	Crystal controlled PLL synthesizer
Transmit frequency	1921.536-1928.448 MHz
Channels	5
Nominal effective range	Maximum power allowed by FCC and IC. Actual operating range may vary according to environmental conditions at the time of use.
Power requirements	Handset: 2.4 VDC, AAAx2, Ni-MH battery pack Telephone base: 6V DC @ 600mA Charger: 6V DC @ 400mA
Memory	Phonebook: 200 memory locations; up to 30 digits and 15 characters Caller ID log: 50 memory locations; up to 24 digits and 15 characters



Designed to fit your home.
And your life.

VTech Communications, Inc. | VTech Technologies Canada Ltd.
A member of THE VTECH GROUP OF COMPANIES.
VTech is a registered trademark of VTech Holdings Limited.
Specifications are subject to change without notice.
© 2021 VTech Communications, Inc. | © 2021 VTech Technologies Canada Ltd.
All rights reserved. 05/21. IS8151-X_IS8152-X_WEBCIB_V1.0

