

Go to www.vtechphones.com
to register your product for
enhanced warranty support and
the latest VTech product news.

CS6648-2
CS6648-3
CS6648-4
CS6649
CS6649-2
CS6649-3

DECT 6.0 cordless telephone



vtech[®]
User's manual

Congratulations

on purchasing your new VTech product. Before using this telephone, please read **Important safety instructions**.

This manual has all the feature operations and troubleshooting necessary to install and operate your new VTech telephone. Please review this manual thoroughly to ensure proper installation and operation of this innovative and feature rich VTech product.

For support, shopping, and everything new at VTech, visit our website at **www.vtechphones.com**. In Canada, please visit **www.vtechcanada.com**.

Compatible with
Hearing Aid T-Coil



Telephones identified with this logo have reduced noise and interference when used with most T-coil equipped hearing aids and cochlear implants. The TIA-1083 Compliant Logo is a trademark of the Telecommunications Industry Association. Used under license.

Important safety instructions

When using your telephone equipment, basic safety precautions should always be followed to reduce the risk of fire, electric shock and injury, including the following:

1. Read and understand all instructions.
2. Follow all warnings and instructions marked on the product.
3. Unplug this product from the wall outlet before cleaning. Do not use liquid or aerosol cleaners. Use a damp cloth for cleaning.
4. Do not use this product near water such as near a bath tub, wash bowl, kitchen sink, laundry tub or swimming pool, or in a wet basement or shower.
5. Do not place this product on an unstable table, shelf, stand or other unstable surfaces.
6. Avoid placing the telephone system in places with extreme temperature, direct sunlight, or other electrical devices. Protect your phone from moisture, dust, corrosive liquids and fumes.
7. Slots and openings in the back or bottom of the telephone base and handset are provided for ventilation. To protect them from overheating, these openings must not be blocked by placing the product on a soft surface such as a bed, sofa or rug. This product should never be placed near or over a radiator or heat register. This product should not be placed in any area where proper ventilation is not provided.
8. This product should be operated only from the type of power source indicated on the marking label. If you are not sure of the type of power

- supply in your home or office, consult your dealer or local power company.
9. Do not allow anything to rest on the power cord. Do not install this product where the cord may be walked on.
 10. Never push objects of any kind into this product through the slots in the telephone base or handset because they may touch dangerous voltage points or create a short circuit. Never spill liquid of any kind on the product.
 11. To reduce the risk of electric shock, do not disassemble this product, but take it to an authorized service facility. Opening or removing parts of the telephone base or handset other than specified access doors may expose you to dangerous voltages or other risks. Incorrect reassembling can cause electric shock when the product is subsequently used.
 12. Do not overload wall outlets and extension cords.
 13. Unplug this product from the wall outlet and refer servicing to an authorized service facility under the following conditions:
 - When the power supply cord or plug is damaged or frayed.
 - If liquid has been spilled onto the product.
 - If the product has been exposed to rain or water.
 - If the product does not operate normally by following the operating instructions. Adjust only those controls that are covered by the operation instructions. Improper adjustment of other controls may result in damage and often requires extensive work by an authorized technician to restore the product to normal operation.
 - If the product has been dropped and the telephone base and/or handset has been damaged.
 - If the product exhibits a distinct change in performance.
 14. Avoid using a telephone (other than cordless) during an electrical storm. There is a remote risk of electric shock from lightning.
 15. Do not use the telephone to report a gas leak in the vicinity of the leak. Under certain circumstances, a spark may be created when the adapter is plugged into the power outlet, or when the handset is replaced in its cradle. This is a common event associated with the closing of any electrical circuit. The user should not plug the phone into a power outlet, and should not put a charged handset into the cradle, if the phone is located in an environment containing concentrations of flammable or flame-supporting gases, unless there is adequate ventilation. A spark in such an environment could create a fire or explosion. Such environments might include: medical use of oxygen without adequate ventilation; industrial gases (cleaning solvents; gasoline vapors; etc.); a leak of natural gas; etc.
 16. Only put the handset of your telephone next to your ear when it is in normal talk mode.
 17. The power adapters are intended to be correctly oriented in a vertical or floor mount position. The prongs are not designed to hold the plug in place if it is plugged into a ceiling, under-the-table or cabinet outlet.

SAVE THESE INSTRUCTIONS

Battery

- **CAUTION:** Use Only Supplied Battery.
- Do not dispose of the battery in a fire. Check with local waste management codes for special disposal instructions.
- Do not open or mutilate the battery. Released electrolyte is corrosive and may cause burns or injury to the eyes or skin. The electrolyte may be toxic if swallowed.
- Exercise care in handling batteries in order not to create a short circuit with conductive materials.
- Charge the battery provided with this product only in accordance with the instructions and limitations specified in this manual.

Precautions for users of implanted cardiac pacemakers

Cardiac pacemakers (applies only to digital cordless telephones):

Wireless Technology Research, LLC (WTR), an independent research entity, led a multidisciplinary evaluation of the interference between portable wireless telephones and implanted cardiac pacemakers. Supported by the U.S. Food and Drug Administration, WTR recommends to physicians that:

Pacemaker patients

- Should keep wireless telephones at least six inches from the pacemaker.
- Should NOT place wireless telephones directly over the pacemaker, such as in a breast pocket, when it is turned ON.
- Should use the wireless telephone at the ear opposite the pacemaker.

WTR's evaluation did not identify any risk to bystanders with pacemakers from other persons using wireless telephones.

About cordless telephones

- **Privacy:** The same features that make a cordless telephone convenient create some limitations. Telephone calls are transmitted between the telephone base and the cordless handset by radio waves, so there is a possibility that the cordless telephone conversations could be intercepted by radio receiving equipment within range of the cordless handset. For this reason, you should not think of cordless telephone conversations as being as private as those on corded telephones.
- **Electrical power:** The telephone base of this cordless telephone must be connected to a working electrical outlet. The electrical outlet should not be controlled by a wall switch. Calls cannot be made from the cordless handset if the telephone base is unplugged, switched off or if the electrical power is interrupted.
- **Potential TV interference:** Some cordless telephones operate at frequencies that may cause interference to televisions and VCRs. To minimize or prevent such interference, do not place the telephone base of the cordless telephone near or on top of a TV or VCR. If interference is experienced, moving the cordless telephone farther away from the TV or VCR often reduces or eliminates the interference.

- **Rechargeable batteries:** Exercise care in handling batteries in order not to create a short circuit with conducting material such as rings, bracelets and keys. The battery or conductor may overheat and cause harm. Observe proper polarity between the battery and the battery charger.
- **Nickel-metal hydride rechargeable batteries:** Dispose of these batteries in a safe manner. Do not burn or puncture the battery. Like other batteries of this type, if burned or punctured, they could release caustic material which could cause injury.

Table of contents

| | |
|--|----|
| What's in the box | 1 |
| Overview | 2 |
| Telephone base overview | 2 |
| Handset overview..... | 4 |
| Charger overview | 5 |
| Display icons overview..... | 5 |
| Handset and telephone base indicators | 6 |
| Connect | 6 |
| Connect the telephone base | 6 |
| Mount the telephone base..... | 6 |
| Install and charge the battery..... | 7 |
| Before use | 8 |
| Set date and time | 8 |
| Check for dial tone | 8 |
| Operating range | 9 |
| Configure your telephone | 9 |
| Using the telephone base/ handset menu | 9 |
| Set language | 9 |
| Set date and time | 10 |
| Home area code..... | 10 |
| Dial mode | 10 |
| Temporary tone dialing..... | 10 |
| Telephone operations | 11 |
| Make a call | 11 |
| Predial a call..... | 11 |
| Answer a call | 12 |
| End a call..... | 12 |
| Speakerphone..... | 12 |
| Volume | 12 |
| Mute | 12 |
| Transfer a call..... | 13 |
| Join a call in progress | 13 |
| Call waiting | 13 |
| Chain dialing..... | 14 |
| Find handset..... | 14 |
| Multiple handset use | 15 |
| Intercom | 15 |
| Answer an incoming call during an intercom call..... | 16 |
| Call transfer using intercom | 16 |
| Redial list | 18 |
| Review a redial list entry | 18 |
| Dial a redial list entry | 18 |
| Delete a redial list entry..... | 18 |
| Directory | 19 |
| Add a directory entry | 19 |
| Review a directory entry..... | 20 |
| Alphabetical search..... | 20 |
| Dial a directory entry | 20 |
| Edit a directory entry | 20 |
| Delete a directory entry | 21 |
| Speed dial | 21 |
| Assign a speed dial number..... | 21 |
| Reassign a speed dial number | 21 |
| Dial a speed dial number | 22 |
| Delete a speed dial number | 22 |
| Caller ID | 23 |
| Review a caller ID log entry | 23 |
| Missed call indicator..... | 23 |
| View dialing options..... | 23 |
| Dial a caller ID log entry | 24 |
| Save a caller ID log entry to the directory .. | 24 |
| Delete caller ID log entries | 24 |
| Sound settings | 25 |
| Key tone | 25 |
| Ringer tone..... | 25 |
| Telephone base ringer volume..... | 26 |
| Handset ringer volume..... | 26 |
| Temporary ringer silencing | 26 |
| Quiet mode..... | 26 |
| About the built-in answering system and voicemail service | 27 |
| Set your built-in answering system | 28 |
| Turn the answering system on or off..... | 28 |
| Default announcement..... | 29 |
| Record your own announcement..... | 29 |
| Play your announcement | 29 |
| Delete your announcement..... | 30 |
| Set number of rings..... | 30 |
| Set recording time | 30 |
| Turn the call screening on or off..... | 30 |
| Turn the message alert tone on or off | 31 |

| | |
|--|-----------|
| Using your built-in answering system.... | 31 |
| Message capacity | 31 |
| New message indication | 31 |
| Message playback | 32 |
| Delete all old messages | 32 |
| Remote access | 33 |
| Set your remote access code | 33 |
| Call screening..... | 34 |
| Call intercept | 34 |
| Temporarily turn off the message alert tone | 34 |
| Record, play and delete memos | 34 |
| Use the built-in answering system and voicemail service | 35 |
| Retrieve voicemail from telephone service | 35 |
| Retrieve voicemail | 35 |
| Voicemail number..... | 35 |
| Turn off the new voicemail indicators..... | 36 |
| Other information | 37 |
| Website | 37 |
| Expand your telephone system | 37 |
| Screen messages | 38 |
| General product care | 40 |
| Frequently asked questions | 40 |
| The RBRC® seal | 43 |
| FCC, ACTA and IC regulations..... | 44 |
| California Energy Commission battery charging testing instructions..... | 46 |
| For C-UL compliance only | 47 |
| Limited warranty..... | 51 |
| Disclaimer and Limitation of Liability..... | 53 |
| Technical specifications | 53 |

What's in the box

Your telephone package contains the following items. Save your sales receipt and original packaging in case it is necessary to ship your telephone for warranty service.

NOTE

To purchase a replacement battery or power adapter, visit our website at

www.vtechphones.com or call

1 (800) 595-9511. In Canada, go to

www.vtechcanada.com or call

1 (800) 267-7377.

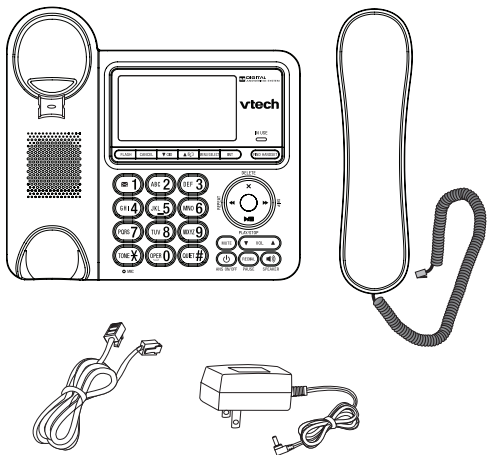

1 set for CS6648-2/CS6648-3/
CS6648-4/CS6649/CS6649-2/
CS6649-3

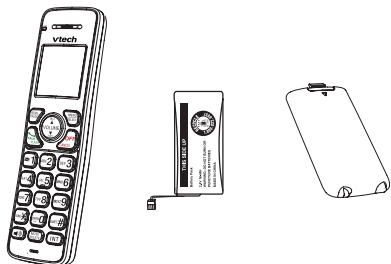

1 set for CS6649;
2 sets for CS6648-2/CS6649-2;
3 sets for CS6648-3/CS6649-3
4 sets for CS6648-4

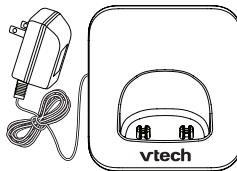

1 set for CS6648-2/CS6649-2;
2 sets for CS6648-3/CS6649-3
3 sets for CS6648-4

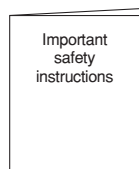
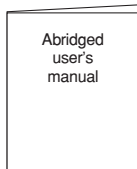

1 set for CS6648-2/CS6648-3/
CS6648-4/CS6649/CS6649-2/
CS6649-3

Overview

Telephone base overview



1 – LCD display

2 – IN USE light

- On when the phone is in use, or when the answering system is answering an incoming call.
- On when a handset is being registered.
- Flashes when there is an incoming call.
- Flashes when handsets are being deregistered.
- Flashes when another telephone on the same line is in use.

3 – FLASH

- During a call, press to answer an incoming call when you receive a call waiting alert.

CANCEL

- While in a menu, press to cancel an operation, back up to the previous menu or exit the menu display.

- Press and hold to erase the missed call indicator when the phone is not in use.
- While the phone is ringing, press to silence the base ringer temporarily.

▼ CID

- Press to scroll down while in menus and lists.
- While entering or modifying names or numbers, press to move the cursor to the left.
- Press to view the caller ID log when the base is not in use.

▲

- Press to scroll up while in menus and lists.
- While entering or modifying names or numbers, press to move the cursor to the right.
- Press to review the directory when the base is not in use.

MENU/SELECT

- Press to show a menu.
- While in a menu, press to select an item, or save an entry or setting.

INT

- Press to initiate or answer an intercom call, or to transfer a call.

FIND HANDSET

- Press to page all handsets when the phone is not in use.

4 – ►/■/PLAY/STOP

- Press to start or stop message playback.
- Flashes when there are new messages or memos in the answering system.

X/DELETE

- Press to delete the playing message or playing announcement.
- While reviewing the redial list, directory or caller ID log, press to delete an individual entry.
- While entering names or numbers, press to delete a character or digit.

◀/REPEAT

- Press once to repeat the playing message.
- Press twice to play the previous message.

▶▶/SKIP

- Press to skip to the next message during message playback.

5 – MUTE

- During a call, press to mute the microphone.
- While the phone is ringing, press to silence the base ringer temporarily.

▼ VOL ▲

- During a call or message playback, press to adjust the listening volume.
- Press to adjust the telephone base ringer volume when the base is not in use.

⏻/ANS ON/OFF

- Press to turn the built-in answering system on or off.

REDIAL/PAUSE

- Press repeatedly to view the last 10 numbers dialed.
- Press and hold to insert a dialing pause while dialing or entering numbers.

🔊/SPEAKER

- Press to make, answer or end a call.
- During a call, press to switch between the corded handset and the base speakerphone.

6 – QUIET #

- Press and hold to set and turn on the quiet mode, or turn it off.
- Press repeatedly to display other dialing options when reviewing a caller ID log entry.

7 – OPER 0

- Press to enter space during text editing.

8 – TONE ✕

- Press to switch to tone dialing during a call if you have pulse service.

9 – MIC

- Microphone.

10 – 1

- While reviewing a caller ID log entry, press repeatedly to add or remove 1 in front of the telephone number before dialing or saving it in the directory.
- Press and hold to set or dial your voicemail number.

11 – Speakerphone

12 – Corded handset

Handset overview

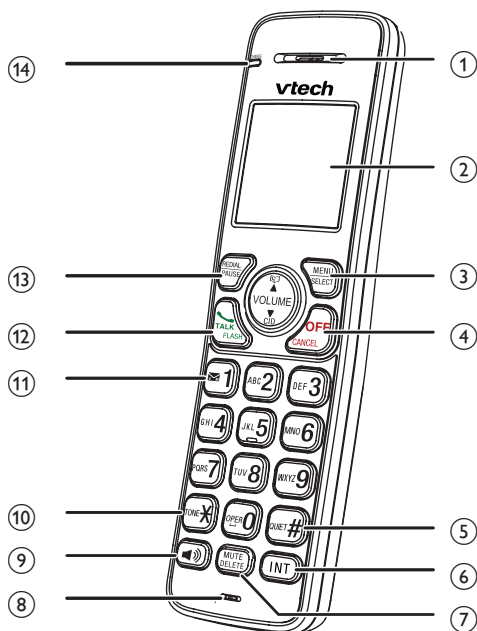

1 – Handset earpiece

2 – LCD display

3 – MENU SELECT

- Show the menu.
- While in a menu, press to select an item or save an entry or setting.

4 – OFF CANCEL

- Hang up a call.
- Return to the previous menu or idle mode without making changes.
- Delete digits while predialing.
- Silence the handset ringer temporarily while the phone is ringing.
- Press and hold to erase the missed call indicator when the phone is not in use.

5 – QUIET

- Press and hold to turn on quiet mode, or turn it off.
- Press repeatedly to display other dialing options when reviewing a caller ID log entry.

6 – INT

- Press to initiate or answer an intercom call, or to transfer a call.

7 – MUTE/DELETE

- Mute the microphone during a call.
- Silence the handset ringer temporarily while the phone is ringing.
- Delete the displayed entry while reviewing the directory, caller ID log or redial list.
- Delete digits or characters when entering numbers or names.
- Delete the playing message or playing announcement.

8 – Microphone

9 – Speaker

- Press to make or answer a call.
- During a call, press to switch between the handset speakerphone and the handset earpiece.

10 – TONE X

- Press to switch to tone dialing during a call if you have pulse service.

11 – Envelope 1

- While reviewing a caller ID log entry, press repeatedly to add or remove 1 in front of the telephone number before dialing or saving it in the directory.
- Press and hold to set or dial your voicemail number.

12 – TALK FLASH



- Press to make or answer a call.
- During a call, press to answer an incoming call when you receive a call waiting alert.

13 – REDIAL/PAUSE

- Review the redial list.
- Press and hold to insert a dialing pause while dialing or entering numbers.

14 – CHARGE light

- On when the handset is charging in the handset charger.

| | |
|---|--|
|  | There are new voicemail received from your telephone service provider. |
| ANS ON | The answering system is turned on. |
| ECO | The ECO mode activates automatically to reduce power consumption when the handset is within range from the telephone base. |
| NEW | The entry you are reviewing is new in the caller ID log. |
|  | The number of current playing message and the total number of messages recorded. |



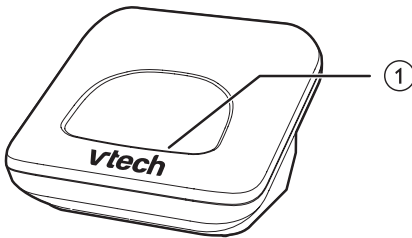

Charger overview





1 – Charging pole

Display icons overview

Handset display icons

| | |
|--|--|
|  | The battery icon flashes when the battery is low and needs charging. |
|  | The battery icon animates when the battery is charging. |
|  | The battery icon becomes solid when the battery is fully charged. |
|  | The handset ringer is off. |

Telephone base display icons



| | |
|---|--|
|  | The telephone base ringer is off. |
|  | There are new voicemail received from your telephone service provider. |
| NEW | The entry you are reviewing is new in the caller ID log. |
|  | <ul style="list-style-type: none"> • The total number of messages recorded when the telephone base is not in use. • The number of the playing message. |

Handset and telephone base indicators

Handset lights overview

| | |
|---|---|
|  | On when the handset speakerphone is in use. |
| CHARGE | On when the handset is charging in the handset charger. |

Telephone base lights overview

| | |
|---|--|
| IN USE | <ul style="list-style-type: none"> On when the telephone line is in use. On when the answering system is answering a call. On when you are registering a handset. Flashes quickly when there is an incoming call. Flashes when another telephone sharing the same line is in use. Flashes when you are deregistering all handsets. |
|  ANS ON/OFF | On when the answering system is turned on. |
|  / SPEAKER | On when the base speakerphone is on. |
|  / PLAY/ STOP | Flashes when there are new memos or messages in the answering system. |
| MUTE | On when mute function is on. |

Connect

You can choose to connect the telephone base for desktop usage or wall mounting.

NOTES

- Use only the adapters provided.
- Make sure the electrical outlets are not controlled by wall switches.
- The adapters are intended to be correctly oriented in a vertical or floor mount position. The prongs are not designed to hold the plug in place if it is plugged into a ceiling, under-the-table or cabinet outlet.

TIP

- If you subscribe to digital subscriber line (DSL) high-speed Internet service through your telephone line, make sure you install a **DSL filter** (not included) between the telephone line cord and telephone wall jack. Contact your DSL service provider for more information.

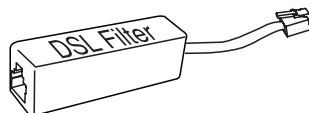

Connect the telephone base

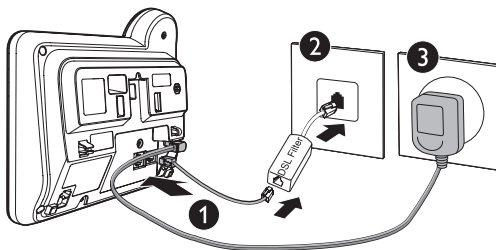

Mount the telephone base

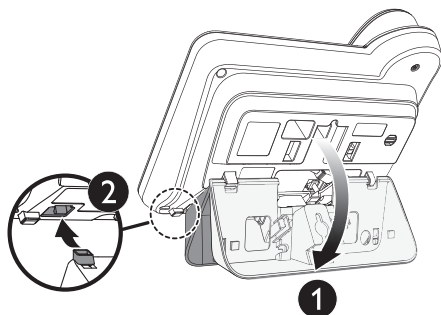

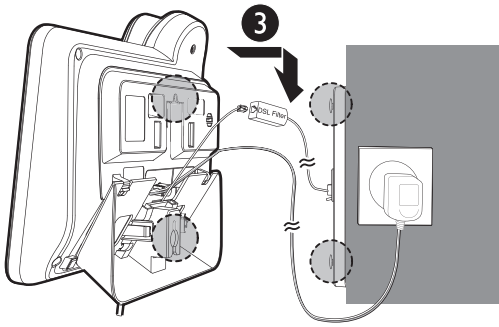

Install and charge the battery

Install the battery

Install the battery as shown below.

NOTES

- Use only supplied battery.
- Charge the battery provided with this product only in accordance with the instructions and limitations specified in this manual.
- If the handset will not be used for a long time, disconnect and remove the battery to prevent possible leakage.

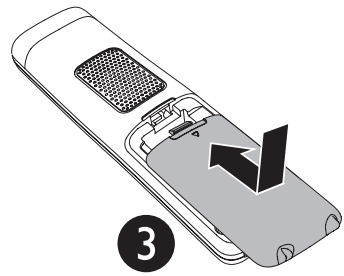
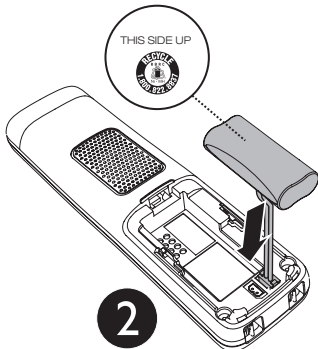
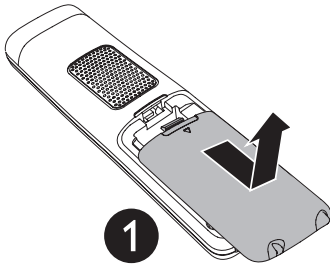

Connect the charger and charge the battery

Place the handset in the telephone base or handset charger to charge.

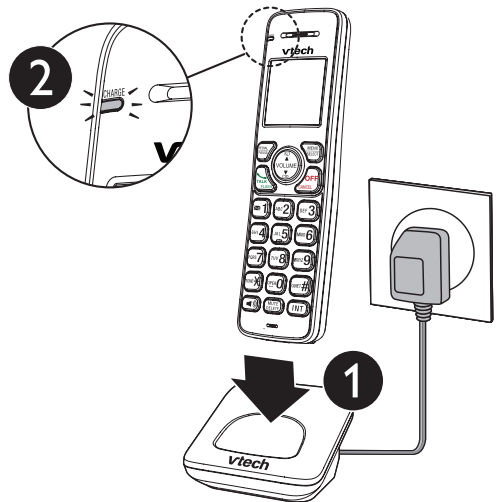



Once you have installed the battery, the handset LCD display indicates the battery status (see the table on next page).

NOTES

- For best performance, keep the handset in the telephone base or charger when not in use.
- The battery is fully charged after 11 hours of continuous charging.
- If you place the handset in the telephone base or the charger without plugging in the battery, the screen displays

NO BATTERY.

| Battery indicators | Battery status | Action |
|---|---|---|
| The screen is blank, or displays Put in charger and  flashes. | The battery has no or very little charge. The handset cannot be used. | Charge without interruption (about 30 minutes). |
| The screen displays Low battery and  flashes. | The battery has enough charge to be used for a short time. | Charge without interruption (about 30 minutes). |
| The screen displays HANDSET X. | The battery is charged. | To keep the battery charged, place it in the handset charger when not in use. |

When the battery is fully charged, you can expect the following performance:

| Operation | Operating time |
|---------------------------------------|-----------------|
| While in handset use (talking*) | Up to 7 hours |
| While in speakerphone mode (talking*) | Up to 3.5 hours |
| While not in use (standby**) | Up to 5 days |

* Operating times vary depending on your actual use and the age of the battery.

** Handset is not charging or in use.

Before use

After you install your telephone or power returns following a power outage, the handset will prompt you to set the date and time.

Set date and time

NOTE

Make sure you set the date and time including the year correctly; otherwise the answering system does not announce the correct day of the week for your recorded messages time stamp.

1. Use the dialing keys **(0-9)** to enter the month **(MM)**, date **(DD)** and year **(YY)**. Then press **SELECT**.
2. Use the dialing keys **(0-9)** to enter the hour **(HH)** and minute **(MM)**. Then press **▼** or **▲** to choose **AM** or **PM**.
3. Press **SELECT** to save.

Check for dial tone

Press  **TALK**. If you hear a dial tone, the installation is successful.



If you do not hear a dial tone:

- Make sure the installation procedures described above are properly done.
- It may be a wiring problem. If you have changed your telephone service to digital service from a cable company or a VoIP service provider, the telephone line may need to be rewired to allow all existing telephone jacks to work. Contact your cable/VoIP service provider for more information.

Operating range

This cordless telephone operates with the maximum power allowed by the Federal Communications Commission (FCC). Even so, this handset and telephone base can communicate over only a certain distance - which can vary with the locations of the telephone base and handset, the weather, and the layout of your home or office.

When the handset is out of range, the handset displays **Out of range or no pwr at base**.

If there is a call while the handset is out of range, it may not ring, or if it does ring, the call may not connect well when you press . Move closer to the telephone base, then press  to answer the call.

If the handset moves out of range during a telephone conversation, there may be interference. To improve reception, move closer to the telephone base.

Configure your telephone

Using the telephone base/handset menu

You can use the telephone base or a cordless handset to change your telephone settings.

1. Press **MENU** when the phone is not in use.
2. Press **▼** or **▲** until the screen displays the desired feature menu.
3. Press **SELECT** to enter that menu.
 - To return to the previous menu, press **CANCEL**.
 - To return to idle mode, press and hold **CANCEL**.

Set language

The LCD language is preset to English. You can select English, French or Spanish to be used in all screen displays.

1. Press **MENU** when the handset/telephone base is not in use.
2. Press **▼** or **▲** to scroll to **Settings**, and then press **SELECT** twice.
3. Press **▼** or **▲** to choose **English**, **Français** or **Español**, then press **SELECT**.
4. Press **SELECT** twice to save your setting. You hear a confirmation tone.

NOTE

If you accidentally change the LCD language to French or Spanish, you can reset it to English easily by pressing **MENU** then entering ***364#**.

Set date and time



Make sure you set the date and time including the year correctly; otherwise the answering system does not announce the correct day of the week for your recorded messages time stamp.

1. Press **MENU** when the handset/ telephone base is not in use.
2. Press ▼ or ▲ to scroll to **Set date/ time**, then press **SELECT**.
3. Use the dialing keys (0-9) to enter the month (MM), date (DD) and year (YY). Then press **SELECT**.
4. Use the dialing keys (0-9) to enter the hour (HH) and minute (MM). Then press ▼ or ▲ to choose **AM** or **PM**.
5. Press **SELECT** to save the settings. You hear a confirmation tone.

Home area code

If you dial your local calls using only seven digits (area code not required), you can program your home area code so that when you receive a call within your local area, the telephone number is automatically stored without the area code in the caller ID log.

1. Press **MENU** when the handset/ telephone base is not in use.
2. Press ▼ or ▲ to scroll to **Settings**, then press **SELECT**.
3. Press ▼ or ▲ to scroll to **Home area code**, then press **SELECT**.
4. Use the dialing keys (0-9) to enter a three-digit home area code.
 - Press **DELETE** on the handset to delete a digit.
 - Press and hold **DELETE** on the handset to delete all digits. Press **X/DELETE** on the telephone base to delete all digits.

5. Press **SELECT** to confirm. You hear a confirmation tone.



If, in the future, your telephone service provider requires you to dial the area code when making a local call, or, if you move to a location that requires it, follow the steps above to delete the home area code you have already programmed. After you have deleted the home area code, ___ will appear on the screen.

Dial mode

The dial mode is preset to touch-tone dialing. If you have pulse (rotary) service, you must change the dial mode to pulse dialing before using the telephone to make a call.

1. Press **MENU** when the handset/ telephone base is not in use.
2. Press ▼ or ▲ to scroll to **Settings**, then press **SELECT**.
3. Press ▼ or ▲ to choose **Dial mode**, then press **SELECT**.
4. Press ▼ or ▲ to choose **Touch-tone** or **Pulse**, then press **SELECT** to save your selection. You hear a confirmation tone.

Temporary tone dialing

If you have pulse (rotary) service only, you can switch from pulse to tone dialing temporarily during a call. This is useful if you need to send touch-tone signals to access your telephone banking or long distance services.

1. During a call, press **TONEX**.
2. Use the dialing keys to enter the number you wish to dial. The telephone sends touch-tone signals. It automatically returns to pulse dialing mode after you end the call.

Telephone operations

Telephone base control key panel:

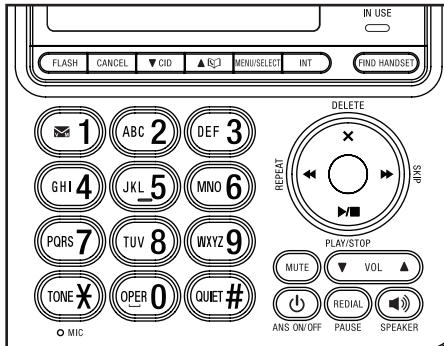

Handset control key panel:

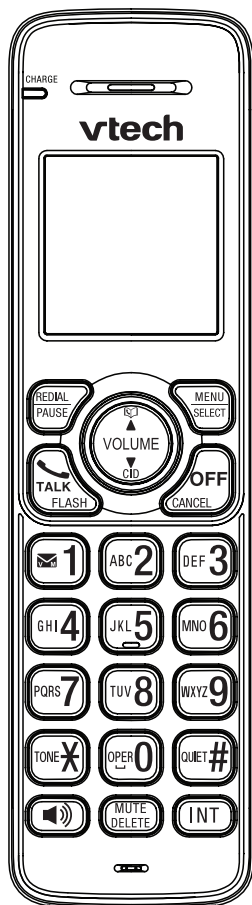

Make a call

Using a cordless handset:

1. Press **TALK** or **SPEAKER**.
2. When you hear a dial tone, dial the number.

Using the telephone base:

1. Lift the corded handset, or press **SPEAKER**.
2. When you hear a dial tone, dial the number.

NOTE

- The screen displays the elapsed time as you talk (in hours, minutes and seconds).

Predial a call

Using a cordless handset:

1. Enter the telephone number using the dialing keys (0-9).
 - Press **DELETE** or **CANCEL** to make corrections.
2. Press **TALK** or **SPEAKER** to dial.

NOTE



- While entering numbers, press and hold PAUSE to insert a dialing pause (a **P** appears).

Using the telephone base:

1. Enter the telephone number using the dialing keys (0-9).
 - Press **X/DELETE** to make corrections.
2. Lift the corded handset, or press **SPEAKER** to dial.
 - While entering numbers, press and hold PAUSE to insert a dialing pause (a **P** appears).
 - If you make a predial call while the telephone line is in use, the screen displays **Unable to call**.

Answer a call

Using a cordless handset:

- Press  **TALK**,  or any of the dialing keys.

Using the telephone base:

- Lift the corded handset, or press  **SPEAKER** or any of the dialing keys.

End a call

Using a cordless handset:

- Press **OFF** or place the handset in the handset charger.

Using the telephone base:

1. When you are using the corded handset, place it on the telephone base.
2. When you are using the base speakerphone, press  **SPEAKER**.

Speakerphone

Handset speakerphone:

When the cordless handset is on a call, press  to switch between the handset speakerphone and the handset earpiece.

When the speakerphone is active, the handset displays **Speaker** and the  light turns on.

Telephone base speakerphone:

When the corded handset is on a call, press  **SPEAKER** to switch between the telephone base speakerphone and the corded handset.

When the speakerphone is active, the telephone base displays **Speaker** and the  **SPEAKER** light turns on.

Volume

To adjust the listening volume on a cordless handset:

- During a call, press **▲/VOLUME** or **▼/VOLUME**.

To adjust the listening volume at the telephone base:

- During a call, press **▼ VOL** or **VOL ▲**.

NOTES

- The handset earpiece volume and speakerphone volume settings are independent.
- When the volume reaches the minimum or maximum setting, you hear two beeps.

Mute

The mute function allows you to hear the other party but the other party cannot hear you.

To mute a call on a cordless handset:

1. During a call, press **MUTE**. The handset displays **Muted** until the mute function is turned off.
2. Press **MUTE** again to resume the conversation. The handset displays **Microphone on** briefly.

To mute a call at the telephone base:

1. During a call, press **MUTE**. The telephone base displays **Muted** and the **MUTE** light turns on until the mute function is turned off.
2. Press **MUTE** again to resume the conversation. The telephone base displays **Microphone on** briefly.



Transfer a call

While on an outside call, you can transfer the call from a cordless handset to another handset or to the telephone base.

1. During a call, press **MENU**.
2. Press ▼ or ▲ to scroll to **Transfer**, then press **SELECT**.
3. Your handset shows **Transfer to:** Press **7** for the telephone base or **1-5** for **HANDSET 1** to **HANDSET 5**.

The outside call is put on hold and your handset shows **Calling HS X/ Calling base**, and then **Transferred**.

The destination device rings and shows **Incoming call**.

4. To answer the call on the destination handset, press ,  or any of the dialing keys.

-OR-

To answer the call on the telephone base, lift the corded handset, or press /SPEAKER or any of the dialing keys.

NOTES



- If the destination device does not answer the call within 30 seconds, the call will be reverted to the originating device. If the originating device does not answer the reverted call within 30 seconds, the call ends.
- If the destination device is in the directory or caller ID log, or is out of range, the originating device displays **Unable to call** and then reconnects to the outside call.

Join a call in progress



Another handset or the telephone base can join you on an outside call. That call continues until all parties hang up. You can use the telephone base and a cordless handset, or two cordless handsets at a time on an outside call.

You can buy additional expansion handsets (**CS6609**) for this telephone base. You can register up to five handsets to the telephone base.

To join a call with a cordless handset:

- When a handset or the telephone base is already on a call, press  or  on another handset to join the call.
- Press **OFF** or place the handset in the handset charger to exit the call. The call continues until both devices hang up.

To join a call with the telephone base:

- Lift the corded handset or press /SPEAKER.
- Place the corded handset back to the telephone base or press /SPEAKER to exit the call. The call continues until both devices hang up.

Call waiting

If you subscribe to call waiting service from your telephone service provider, you hear an alert tone when there is an incoming call while you are already on a call.

- Press **FLASH** to put your current call on hold and take the new call.
- Press **FLASH** to switch back and forth between calls.

If you also subscribe to caller ID service, it will let you see the name and telephone number of the caller during call waiting.

It may be necessary to change your telephone service to use this feature.

Contact your telephone service provider if:

- You have both caller ID and call waiting, but as separate service (you may need to combine these services);
- You have only caller ID service, or only call waiting service; or
- You do not subscribe to caller ID or call waiting services.

There are fees for caller ID services. In addition, services may not be available in all areas.

Chain dialing

Use this feature on the cordless handsets to initiate a dialing sequence from numbers stored in the directory, caller ID log or redial list while you are on a call.

Chain dialing can be useful if you wish to access other numbers (such as bank account numbers or access codes) from the directory, caller ID log or redial list.

To access a number from the directory while on a call:

1. Press **MENU**.
2. Press **SELECT** to choose **Directory**.
3. Press **▼** or **▲** to scroll to the desired entry.
4. Press **SELECT** to dial the displayed number.

To access a number from the caller ID log while on a call:

1. Press **MENU**.
2. Press **▼** or **▲** to scroll to **Caller ID log**, then press **SELECT**.
3. Press **▼** or **▲** to scroll to the desired entry.
4. Press **SELECT** to dial the displayed number.

To access a number from the redial list while on a call:

1. Press **REDIAL** to enter the redial list.
2. Press **▼**, **▲** or **REDIAL** repeatedly to browse to the desired entry.
3. Press **SELECT** to dial the displayed number.

NOTE

Press **CANCEL** to exit the directory, caller ID log or redial list while on a call.

Find handset

This feature helps you find misplaced handsets.

To start paging:

- Press **FIND HANDSET** on the telephone base and its screen displays **** Paging ****. All idle handsets ring and display **** Paging ****.

To stop paging:

- Press **TALK**, **OFF** or any of the dialing keys on the cordless handset.

-OR-

- Place the cordless handset to the handset charger.

-OR-

- Press **FIND HANDSET** on the telephone base.

NOTES

- Press **MUTE** to turn off the ringer of that handset temporarily. Paging tone continues on all other idle handsets.
- Do not press and hold **FIND HANDSET** for more than four seconds. It may lead to handset deregistration. If the handset displays **To register HS** and **See manual**, refer to the **Frequently asked questions** section to register the handset back to the telephone base.

Multiple handset use



Intercom

Use the intercom feature for conversations between the telephone base and a cordless handset, or two cordless handsets.

When you have two or more handsets, use the handset number to initiate an intercom call or to transfer a call.

- Press **7** for the telephone base or **1-5** for **HANDSET 1** to **HANDSET 5**.

To initiate an intercom call with a cordless handset:

1. Press **INT** on the cordless handset when it is not in use.
 - If you have only one handset, the telephone base shows **Calling base**. The telephone base rings and shows **HS 1 is calling**.
 - If you have two or more handsets, your handset shows **Intercom to**. Use the dialing keys to enter a device number. Your handset shows **Calling HS X/Calling base**. The destination device rings and shows **HS X is calling**.
2. To answer the intercom call on the destination handset, press , **INT**,  or any of the dialing keys. Both handsets now show **Intercom**.

-OR-

To answer the intercom call at the telephone base, press , **INT**, any of the dialing keys, or lift the corded handset. Both devices now show **Intercom**.

3. To end the intercom call on either handset, one party presses **OFF**, or places the handset back in the handset charger. Both handsets display **Intercom ended**.



-OR-

To end the intercom call at the telephone base, press **INT** or  **SPEAKER** when using the base speakerphone, or place the corded handset back to the telephone base. Both screens display **Intercom ended**.

NOTES

- You can cancel the intercom call before it is answered by pressing **CANCEL** or **INT**.
- If the destination handset is not powered, out of range, on a call, or does not answer the intercom call within 100 seconds, your handset displays **Unable to call** and then returns to idle mode.
- If the telephone base is on a call, or does not answer the intercom call within 100 seconds, your handset displays **Unable to call** and then returns to idle mode.
- You can press **OFF** or **MUTE** on the cordless handset, or **CANCEL** or **MUTE** on the telephone base to temporarily silence the intercom ringer.
- Two intercom calls can be established at a time.

To initiate an intercom call at the telephone base:

1. Press **INT** on the telephone base when it is not in use.
 - If you have only one handset, the telephone base shows **Calling HS 1**. The handset rings and shows **Base is calling**.
 - If you have two or more handsets, the telephone base shows **Intercom to**. Use the dialing keys to enter a handset number. The telephone base shows **Calling HS X**. The destination handset rings and shows **Base is calling**.
2. To answer the intercom call on the destination handset, press , **INT**,  or any of the dialing keys. Both devices now show **Intercom**.

3. To end the intercom call at the telephone base, press **INT**, or **📞/SPEAKER** when using the base speakerphone, or place the corded handset back to the telephone base. Both screens display **Intercom ended**.

-OR-

To end the intercom call on the destination handset, press **OFF**, or place the handset back in the handset charger. Both screens display **Intercom ended**.

NOTES

- If you do not have any cordless handset registered to the telephone base, you will hear two beeps when you press **INT** on the base.
- You can cancel the intercom call before it is answered by pressing **CANCEL** or **INT**.
- If the destination handset is not powered, out of range, on a call, or does not answer the intercom call within 100 seconds, your telephone base displays **Unable to call** and then returns to idle mode.

Answer an incoming call during an intercom call

If you receive an incoming outside call during an intercom call, you will hear an alert tone.

To answer on a cordless handset:

- To answer the call, press **TALK**. The intercom call ends automatically.
- To end the intercom call without answering or canceling the incoming call, press **OFF**. The telephone continues to ring.

To answer at the telephone base:

- Press **📞/SPEAKER**, or place the corded handset back to the base. The intercom call ends automatically. Then

press **📞/SPEAKER**, or lift up the corded handset to answer the call.

- To end the intercom call without answering or canceling the incoming call, press **📞/SPEAKER**, or place the corded handset back to the base. The telephone continues to ring.

Call transfer using intercom

Use the intercom feature to transfer an outside call to another cordless handset or the telephone base.

To transfer a call with a cordless handset:

1. During a call, press **INT**.
 - If you have only one handset, the outside call is put on hold and your handset shows **Calling base**. The telephone base rings and shows **HS 1 is calling**.
 - If you have two or more handsets, your handset shows **Intercom to**. Use the dialing keys to enter a device number. The outside call is put on hold and your handset shows **Calling HS X/Calling base**. The destination device rings and shows **HS X is calling**.

2. To answer the call on the destination handset, press **TALK**, **INT**, **📞**, or any of the dialing keys. The outside call is still on hold and both handsets display **Intercom**. You can now have a private intercom conversation.

-OR-

To answer the call at the telephone base, press **INT**, **📞/SPEAKER**, any of the dialing keys or lift the corded handset. The outside call is still on hold and both devices display **Intercom**. You can now have a private intercom conversation.



- To cancel the intercom call before it is answered, press **OFF**,  or **INT** on your handset.
- If the destination handset is not powered, out of range, on a call, or does not answer the intercom call within 100 seconds, your handset displays **Unable to call** and then automatically returns to the external call.
- If the telephone base is on a call, or does not answer the intercom call within 100 seconds, your handset displays **Unable to call** and then automatically returns to the external call.

Options during intercom call:

- You can transfer the call. Press **OFF** on the originating handset or return it to the handset charger. Your handset shows **Transferred**. The destination device is then connected to the outside call.
- You can press **INT** on your handset to alternate between the outside call (**Outside call** appears) and the intercom call (**Intercom** appears).
- You can end the intercom call and continue the outside call with the originating handset.
 - Press  on your handset, or the other party can press **OFF** on the handset or **INT** on the telephone base, or place the handset back in the handset charger, or place the corded handset back to the base.
- You can let the other device join you on the outside call in a three-way conversation. Press and hold **INT** on the originating handset.

To transfer a call at the telephone base:

1. During a call, press **INT**.
 - If you have only one handset, the outside call is put on hold and the telephone base shows **Calling HS 1**. The handset rings and shows **Base is calling**.

- If you have two or more handsets, the telephone base shows **Intercom to**. Use the dialing keys to enter a handset number. The outside call is put on hold and the telephone base shows **Calling HS X**. The destination handset shows **Base is calling**.
2. To answer the call on the destination handset, press , **INT**, , or any of the dialing keys. The outside call is still on hold and both devices display **Intercom**. You can now have a private intercom conversation.

 NOTES

- To cancel the intercom call before it is answered, press **CANCEL** or **INT** on the telephone base.
- If the destination handset is not powered, out of range, on a call, or does not answer the intercom call within 100 seconds, your telephone base displays **Unable to call** and then automatically returns to the external call.

Options during intercom call:

- You can transfer the call. Press / **SPEAKER** or place the corded handset back to the telephone base. Both screens display **Intercom ended**. The destination handset is then connected to the outside call.
- The other party can press **OFF** on the handset to end the intercom call. The telephone base is still connected to the outside call.
- You can let the other handset join you on the outside call in a three-way conversation. Press **SELECT** on the telephone base.

Redial list



Each handset and the telephone base store the last 10 telephone numbers dialed (up to 30 digits) independently. When there are already 10 entries, the oldest entry is deleted to make room for the new entry.

Review a redial list entry



1. Press **REDIAL** on the handset or the telephone base when the phone is not in use.
2. Press **▼**, **▲** or **REDIAL** repeatedly until the desired entry displays.

Dial a redial list entry

Using a cordless handset:

1. Press **REDIAL** on the handset when the phone is not in use.
2. Press **▼**, **▲** or **REDIAL** repeatedly to browse.
3. When the desired entry displays, press  or  to dial.

-OR-

1. Press  or  when the phone is not in use.
2. Press **REDIAL**.
3. Press **▼**, **▲** or **REDIAL** repeatedly to browse.
4. When the desired entry displays, press **SELECT** to dial.

Using the telephone base:

1. Press **REDIAL** when the phone is not in use.
2. Press **▼**, **▲** or **REDIAL** repeatedly to browse.
3. When the desired entry displays, lift the corded handset or press **SPEAKER** to dial.

-OR-

1. Lift the corded handset or press **SPEAKER** when the phone is not in use.
2. Press **REDIAL**.
3. Press **▼**, **▲** or **REDIAL** repeatedly to browse.
4. When the desired entry displays, press **SELECT** to dial.

Delete a redial list entry

Using a cordless handset:

While the screen displays the desired number, press **DELETE** to delete the redial number.

Using the telephone base:

While the screen displays the desired number, press **X/DELETE** to delete the redial number.

Directory

The directory can store up to 50 entries, which are shared by all handsets and the telephone base. Any modifications made on one device apply to all. Each entry may consist of a telephone number with up to 30 digits and a name with up to 15 characters.

If the telephone number in the directory exceeds 15 digits, a dash appears after the 14th digit and then the remaining digits are shown beginning with a dash, alternately.

Only one system device can review the directory at a time. When a device tries to enter the directory while another device is already in it, **Not available** appears.

Add a directory entry

1. Enter the number when the phone is not in use. Press **MENU**, then go to Step 3.

-OR-

- Press **MENU** on the cordless handset when the phone is not in use, or press **MENU** on the telephone base when the telephone base is not in use.
- Press ▼ or ▲ to scroll to **Directory**, then press **SELECT**.
- Press ▼ or ▲ to scroll to **Add contact**, then press **SELECT**.

2. When **Enter number** displays, use the dialing keys to enter the number.

-OR-

Copy a number from the redial list by pressing **REDIAL**. Then press ▼, ▲ or **REDIAL** repeatedly to find the desired number. Press **SELECT** to copy the number.

3. Press **SELECT** to move on to the name. The screen displays

Enter name.

4. Use the dialing keys to enter the name. Additional key presses show other characters of that particular key. The first character of each word is capitalized.
5. Press **SELECT** to save. The screen displays **Saved** and you hear a confirmation tone.

-OR-

1. Use the dialing keys to enter a number (up to 30 digits) on the cordless handset or on the telephone base when the phone is not in use. Press **SELECT** and then the screen displays **Enter number**.

-OR-

Copy a number from the redial list by pressing **REDIAL**. Then press ▼, ▲ or **REDIAL** repeatedly to find the desired number.

Press **SELECT** to copy the number.

2. Press **SELECT** to move on to the name.
3. When **Enter name** displays, use the dialing keys to enter the name. Additional key presses show other characters of that particular key. The first character of each word is capitalized.
4. Press **SELECT** to save. The screen displays **Saved** and you hear a confirmation tone.

While entering names and numbers, you can:





- Press **DELETE** to backspace and erase a digit or character.
- Press and hold **DELETE** to erase the entire entry.
- Press ▼ or ▲ to move the cursor to the left or right.
- Press and hold **PAUSE** to insert a

dialing pause (for entering numbers only).







- Press **0** to add a space (for entering names only).

Review a directory entry



Entries are sorted alphabetically.

1. Press  on the cordless handset when the phone is not in use, or  on the telephone base when the telephone base is not in use to show the first entry in the directory.
2. Press  or  to browse through the directory, or use the dialing keys to start a name search.

-OR-



1. Press **MENU** on the cordless handset or on the telephone base when the phone is not in use.
2. Press  or  to scroll to **†Directory**, then press **SELECT**.
3. Press  or  to scroll to **†Review**, then press **SELECT**.
4. Press  or  to browse through the directory.

Alphabetical search

1. Follow the steps in **Review a directory entry** above to enter the directory.
2. Use the dialing keys to enter the letter associated with the name. For example, if you have the entries named Jennifer, Jessie, Kevin and Linda in your directory, press **5** (JKL) once to see **Jennifer** (when **Jennifer** displays, press  to see **Jessie**), twice to see **Kevin**, or three times to see **Linda**. If there is no name entry matching your search, the next closest match in alphabetical order appears. If necessary, press  or 

browse.





Dial a directory entry

1. Search for the desired entry in the directory (see **Review a directory entry** or **Alphabetical search**).
2. To dial the displayed entry on the cordless handset, press  or .

-OR-

To dial the displayed entry on the telephone base, press /SPEAKER, or lift the corded handset.

-OR-

1. Press  or  on the cordless handset.
2. Press **MENU**.
3. Press **SELECT** to select **†Directory**.
4. Press  or  or start an alphabetical search to browse to the desired entry, then press **SELECT** to dial the displayed number.

Edit a directory entry

1. Search for the desired entry in the directory (see **Review a directory entry** or **Alphabetical search**).
2. When the desired entry displays, press **SELECT**. The screen displays **Edit number** and the stored number.
3. Use the dialing keys to edit the number, then press **SELECT**. The screen displays **Edit name** and then the stored name.
4. Use the dialing keys to edit the name. Additional key presses show other characters of that particular key. The first character of each word is capitalized.
5. Press **SELECT** to save. The screen displays **Saved** and then the revised

entry. You hear a confirmation tone.

While entering names and numbers, you can:

- Press **DELETE** to backspace and erase a digit or character.
- Press and hold **DELETE** to erase the entire entry.
- Press **▼** or **▲** to move the cursor to the left or right.
- Press and hold **PAUSE** to insert a dialing pause (for entering numbers only).
- Press **0** to add a space (for entering names only).

Delete a directory entry

1. Search for the desired entry in the directory (see **Review a directory entry** or **Alphabetical search**).
2. When the desired entry appears, press **DELETE**. The screen displays **Delete contact?** with the telephone number.
3. Press **SELECT** to confirm. The screen displays **Contact deleted**. You hear a confirmation tone.

Speed dial

You can copy up to nine directory entries into the speed dial locations (**0** and **2-9**) so that you can dial these numbers more quickly.

The speed dial memory locations are stored at the telephone base and are shared by all system devices. Changes made to the speed dial entries on one system device apply to all.

Assign a speed dial number

1. Press **MENU** when the phone is not in use.
2. Press **▼** or **▲** to scroll to **◆Directory**, then press **SELECT**.
3. Press **▼** or **▲** to scroll to **◆Speed dial**, then press **SELECT**.
4. Press **▼**, **▲** or a dialing key (**0** or **2-9**) to choose the desired speed dial location.
5. Press **SELECT**. The screen displays **Copy from DIR...** and then the first entry in the directory.
6. Press **▼** or **▲** to scroll to desired entry.
7. Press **SELECT** to save your selection. You hear a confirmation tone.

Reassign a speed dial number



1. Press **MENU** when the phone is not in use.
2. Press **▼** or **▲** to scroll to **◆Directory**, then press **SELECT**.
3. Press **▼** or **▲** to scroll to **◆Speed dial**, then press **SELECT**.
4. Press **▼**, **▲** or a dialing key (**0** or **2-9**) to choose the speed dial location you want to reassign.
5. Press **SELECT** twice. The screen displays **◆Reassign SD**.

6. Press **SELECT**. The screen briefly shows **Copy from DIR...** then the first entry of the directory.
7. Press ▼ or ▲ to scroll to the desired entry.
8. Press **SELECT** to save your selection. You hear a confirmation tone.

Dial a speed dial number

- When the phone is not in use, press and hold a dialing key (**0** or **2-9**) to dial the number stored in the corresponding speed dial location.

-OR-

1. Press **MENU** when the phone is not in use.
2. Press ▼ or ▲ to scroll to **Directory**, then press **SELECT**.
3. Press ▼ or ▲ to scroll to **Speed dial**, then press **SELECT**.
4. Press ▼, ▲ or a dialing key (**0** or **2-9**) to choose the desired speed dial location.
5. When you are using a cordless handset, press  **TALK** or .

-OR-

When you are using the telephone base, press  **SPEAKER** or lift the corded handset.

Delete a speed dial number

1. Press **MENU** when the phone is not in use.
2. Press ▼ or ▲ to scroll to **Directory**, then press **SELECT**.
3. Press ▼ or ▲ to scroll to **Speed dial**, then press **SELECT**.
4. Press ▼, ▲ or a dialing key (**0** or **2-9**) to choose the desired speed dial location, then press **SELECT** to show

the speed dial entry.

5. Press **SELECT** again. Then press ▼ or ▲ to scroll to **Clear SD** and then press **SELECT**. The screen shows **Clear SD #X?**

-OR-

Press **DELETE**. The screen shows **Clear SD #X?**

6. Press **SELECT** to confirm. You hear a confirmation tone.

 **NOTE**

Deleting the speed dial entries does not affect the entries in the directory.

Caller ID

If you subscribe to caller ID service, information about each caller will appear after the first or second ring. If you answer a call before the caller's information appear on the screen, it will not be saved in the caller ID log.

The caller ID log stores up to 50 entries. Each entry has up to 24 digits for the phone number and 15 characters for the name.

If the phone number has more than 15 digits, only the last 15 digits appear. If the name has more than 15 characters, only the first 15 characters are shown and saved in the caller ID log.

Entries appear in reverse chronological order. When the caller ID log is full, the oldest entry is deleted to make room for new incoming call information.

Caller ID log entries are shared by all system devices. Any modifications made on one device apply to all.

NOTES

- Only one system device can review the caller ID log at a time. If a system device tries to enter the caller ID log while another system device is already in it, its screen displays **Not available**.
- This product can provide information only if both you and the caller are in areas offering caller ID service and if both telephone service providers use compatible equipment. The time and date are sent by your telephone service provider along with the call information.

Review a caller ID log entry

1. Press **CID** on the cordless handset or on the telephone base when the phone is not in use.
2. Press **▼** or **▲** to browse through the caller ID log.

-OR-

1. Press **MENU** on the cordless handset or on the telephone base when the phone is not in use.
2. Press **▼** or **▲** to scroll to **⇧Caller ID log**, then press **SELECT**.
3. Press **SELECT** to select **⇧Review**.
4. Press **▼** or **▲** to browse.

Missed call indicator

When there are calls that have not been reviewed in the caller ID log, the screens display **XX missed calls**.

Each time you review a caller ID log entry marked **NEW** on the handset or **NEW** on the telephone base, the number of missed calls decreases by one.

When you have reviewed all the missed calls, the missed call indicator no longer displays.

If you do not want to review the missed calls one by one, press and hold **CANCEL** when in idle mode to clear the missed call indicator. All the entries are then considered old and kept in the caller ID log.



View dialing options

Although the caller ID log entries received have 10 digits (the area code plus the seven-digit number), in some areas, you may need to dial only the seven digits, or 1 plus the seven digits, or 1 plus the area code plus the seven digits. You can change the number of digits that you dial from the caller ID

log and store the new number to the directory.

While reviewing the caller ID log, press **QUIET#** repeatedly to display different dialing options for local and long distance numbers before dialing or saving the telephone number in the directory.

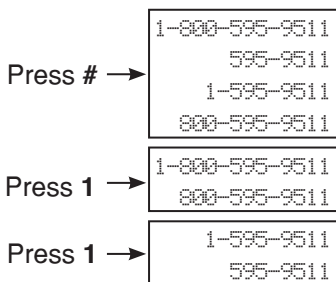

Press **☑ 1** repeatedly if you need to add or remove 1 in front of the telephone number before dialing or saving it in the directory.

When the number is displayed in the correct format for dialing, press  or  on a cordless handset, or press  **SPEAKER** or lift the corded handset on the telephone base to dial.



Dial a caller ID log entry

To dial on a cordless handset:

- When the number is shown in the correct format for dialing, press  or  to dial.

To dial at the telephone base:

- When the number is shown in the correct format for dialing, press  **SPEAKER** or lift the corded handset to dial.

Save a caller ID log entry to the directory

1. When in the caller ID log, press ▼ or ▲ to browser.
2. When the desired caller ID log entry displays, press **SELECT**. The screen displays **Edit number** and the stored number.
3. Use the dialing keys to edit the number, if necessary. Then press **SELECT**. The screen displays **Edit name** and the stored name.
4. Use the dialing keys to edit the name, if necessary. Then press **SELECT**. The screen shows **Saved**. You hear a confirmation tone.

While entering names and numbers, you can:

- Press **DELETE** to backspace and erase a digit or character.
- Press and hold **DELETE** to erase the entire entry.
- Press ▼ or ▲ to move the cursor to the left or right.
- Press and hold **PAUSE** to insert a dialing pause (for entering numbers only).
- Press **0** to add a space (for entering names only).

Delete caller ID log entries

1. When in the caller ID log, press ▼ or ▲ to browser.
2. When the desired caller ID log entry displays, press **DELETE**. The handset displays **Deleting...** and you hear a confirmation tone.

To delete all caller ID log entries:

1. Press **MENU** on the cordless handset or on the telephone base when the phone is not in use.

2. Press ▼ or ▲ to scroll to **⇨Caller ID log**, then press **SELECT**.
3. Press ▼ or ▲ to scroll to **⇨Del all calls**, then press **SELECT**.
4. When the screen shows **Delete all?**, press **SELECT** to confirm. You hear a confirmation tone.

Sound settings

Key tone

You can turn the key tone on or off for each handset and the telephone base. If you turn the key tone on, the handset/telephone base beeps with each key press. If you turn the key tone off, there are no beeps when you press the handset/telephone base keys.

1. Press **MENU** when the handset/telephone base is not in use.
2. Press ▼ or ▲ to scroll to **⇨Settings**, then press **SELECT**.
3. Press ▼ or ▲ to scroll to **⇨Key tone**, then press **SELECT**.
4. Press ▼ or ▲ to select **⇨Key tone:On** or **⇨Key tone:Off**.
5. Press **SELECT** to save your selection. You hear a confirmation tone.

Ringer tone

You can choose from different ringer tones for each handset and the telephone base.

1. Press **MENU** when the handset/telephone base is not in use.
2. Press ▼ or ▲ to scroll to **⇨Ringers**, then press **SELECT**.
3. Press ▼ or ▲ to scroll to **⇨Ringer tone**, then press **SELECT**.
4. Press ▼ or ▲ to sample each ringer tone.
5. Press **SELECT** to save your selection. You hear a confirmation tone.

NOTE

If you turn off the ringer volume on a cordless handset, you will not hear ringer tone samples.

Telephone base ringer volume

Press **▼ VOL** or **VOL ▲** on the telephone base to adjust the ringer volume when the telephone base is not in use.

When you set the ringer volume to zero, the base ringer is off. The telephone base announces, “*Base ring is off,*” and displays **Ringer off** and .

Handset ringer volume

You can set the ringer volume or turn the ringer off. When the ringer is off, **Ringer off** and  appear on the screen.

1. Press **MENU** when the handset/telephone base is not in use.
2. Press **▼** or **▲** to scroll to **↑Ringers**, then press **SELECT**.
3. Press **SELECT** to select **↑Ringer volume**.
4. Press **▼** or **▲** to sample each volume level.
5. Press **SELECT** to save your selection. You hear a confirmation tone.

NOTE

When the ringer volume is set to off, the handset still rings when you press **FIND HANDSET** at the telephone base.

Temporary ringer silencing

When the telephone is ringing, you can temporarily silence the handset ringer/telephone base ringer without disconnecting the call. The next call rings normally at the preset volume.

To silence the handset ringer:

- Press **MUTE** or **CANCEL** on the handset and it displays **Ringer muted** and .

To silence the telephone base ringer:

- Press **MUTE** or **CANCEL** on the telephone base and it displays .

Quiet mode

You can turn on quiet mode for a period of time (1-12 hours). During this period, all tones (except paging tone) and call screening are muted.

When you turn on the quiet mode, the answering system turns on automatically. When the quiet mode duration expires, the answering system remains on.

To set and turn the quiet mode on:

1. Press and hold **QUIET#** when the handset/telephone base is not in use. The screen shows **Quiet: _ _ hours (1-12)**.
2. Use the dialing keys to enter the desired duration (1-12), then press **SELECT**. All screens display **Quiet mode on** and . The **Ⓞ/ANS ON/OFF** light on the telephone base turns on.

To turn the quiet mode off:

- While the quiet mode is on, press and hold **QUIET#**. The screen displays **Quiet mode off** briefly and then returns to idle.

NOTE

When you change the settings of the ringer tone or ringer volume, you can still hear the samples even if the quiet mode is on.

About the built-in answering system and voicemail service

For message recording, your telephone has a built-in answering system, and it also supports voicemail service offered by your telephone service provider (subscription is required, and fee may apply).

The main differences between them are:

| Category | Built-in answering system | Voicemail from telephone service |
|----------|---|---|
| Storage | Messages are stored in the telephone base. | Messages are stored in a server or system provided by your telephone service provider. |
| | You messages will not be deleted automatically. You have to delete your message manually. | Your messages may be automatically deleted after a period of time. Contact your telephone service provider for more details. |

| Category | Built-in answering system | Voicemail from telephone service |
|-----------------------------|---|--|
| Method to retrieve messages | When you received new messages, the handset and the telephone base both display XX new messages , and the ►/■/PLAY/STOP light on the telephone base flashes. | When you receive new messages, the handset and the telephone base display  and New voicemail . |
| | To retrieve messages, usually there are two ways: <ul style="list-style-type: none"> • Press ►/■/PLAY/STOP on the telephone base; or • Access remotely with an access code. | To retrieve messages, you need an access number and/or a password provided by your telephone service provider. |

Telephone base control key panel:

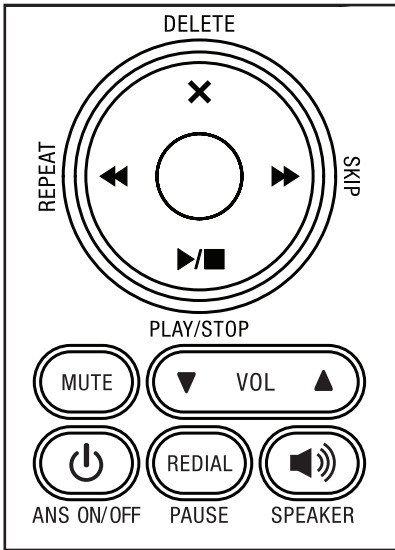

Set your built-in answering system

The answering system can record and store up to 99 messages. Each message can be up to three minutes in length. The total storage capacity for the announcement, messages and memos is approximately 14 minutes. The actual recording time depends on individual message characteristics.

Your answering system allows you to set your announcement, to save and delete messages, activate call screening, to set number of rings before pick up, to access remotely, and to control the recording time.

Turn the answering system on or off

The answering system must be turned on to answer and record messages.

When the answering system is turned on, the /ANS ON/OFF light on the telephone base turns on and **ANS ON** displays on the handset.

To turn on or off with the telephone base:

- Press /ANS ON/OFF to turn the built-in answering system on or off. When the answering system is turned on, the base displays **Ans sys on** and announces, “Calls will be answered.” When the answering system is turned off, the base displays **Ans sys off** and announces, “Calls will not be answered.”

To turn on or off with the handset:

1. Press **MENU** when the phone is not in use.
2. Press ▼ or ▲ to scroll to **Answering sys**, then press **SELECT**.
3. Press ▼ or ▲ to scroll to **Answer on/off**, then press **SELECT**.
4. Press ▼ or ▲ to scroll to **Answer: On** or **Answer: Off**, then press **SELECT** to confirm. You hear a confirmation tone.

NOTES

- When you turn on the answering system at the telephone base with no memory capacity left, **Memory full** displays on the cordless handset and telephone base.
- If the memory capacity is less than 3 minutes, the telephone announces, *“Less than three minutes to record.”*

Default announcement

The telephone is preset with a greeting that answers calls with, *“Hello. Please leave a message after the tone.”* You can use this preset announcement, or replace it with your own.

Record your own announcement

The announcement can be up to 90 seconds in length.

1. Press **MENU** when the phone is not in use.
2. Press ▼ or ▲ to scroll to **Answering sys**, then press **SELECT**.
3. Press **SELECT** again to select **Announcement**. The system announces, *“To play, press 2. To record, press 7.”*
4. Press **7** to record an announcement. The system announces, *“Record after the tone. Press 5 when you are done.”*

5. After the tone, speak towards the microphone.
6. Press **5** when done. The answering system automatically plays back the newly recorded announcement, then returns to the previous menu.

-OR-

Press **CANCEL** to return to the previous menu.

NOTE

Announcement shorter than two seconds will not be recorded.

Play your announcement

1. Press **MENU** when the phone is not in use.
2. Press ▼ or ▲ to scroll to **Answering sys**, then press **SELECT**.
3. Press **SELECT** again to select **Announcement**. The system announces, *“To play, press 2. To record, press 7.”*
4. Press **2** to play the current announcement.

Options during playback:

- Press ▼/**VOLUME** or ▲/**VOLUME** on the cordless handset, or ▼ **VOL** or **VOL** ▲ on the telephone base to adjust the listening volume.
- Press **5** to stop playback.
- Press **⏮** on the cordless handset to switch between speakerphone mode and handset mode.

Delete your announcement

1. Press **MENU** when the phone is not in use.
2. Press **▼** or **▲** to scroll to **◆Answering sys**, then press **SELECT**.
3. Press **SELECT** again to select **◆Announcement**. The system announces, *"To play, press 2. To record, press 7."*
4. Press **3** or **DELETE** to delete your recorded announcement. The screen displays **Annnc deleted**. You hear a long beep.

NOTE

When your announcement is deleted, calls are answered with the default announcement.

Set number of rings

You can set the answering system to answer an incoming call after two, three, four, five or six rings; or toll saver.

If you choose toll saver, the answering system answers a call after two rings if you have new messages, or after four rings when there are no new messages. This enables you to check for new messages and avoid paying unnecessary long distance charges when you are calling from outside your local area.

1. Press **MENU** when the phone is not in use.
2. Press **▼** or **▲** to scroll to **◆Answering sys**, then press **SELECT**.
3. Press **▼** or **▲** to scroll to **◆Ans sys setup**, then press **SELECT**.
4. Press **▼** or **▲** to scroll to **◆# of rings**, then press **SELECT**.
5. Press **▼** or **▲** to select **◆2**, **◆3**, **◆4**, **◆5**, **◆6** or **◆Toll saver**.

6. Press **SELECT** to save and you hear a confirmation tone.

NOTE

If you subscribe to voicemail service from your telephone service provider, see **Answering system and voicemail**.

Set recording time

You can set the recording time allowed for each incoming message. The message length is three minutes by default.

1. Press **MENU** when the phone is not in use.
2. Press **▼** or **▲** to scroll to **◆Answering sys**, then press **SELECT**.
3. Press **▼** or **▲** to scroll to **◆Ans sys setup**, then press **SELECT**.
4. Press **▼** or **▲** to scroll to **◆Recording time**, then press **SELECT**.
5. Press **▼** or **▲** to select **◆3 minutes**, **◆2 minutes** or **◆1 minute**.
6. Press **SELECT** to save and you hear a confirmation tone.

Turn the call screening on or off

You can hear incoming messages at the telephone base while they are being recorded.

1. Press **MENU** when the phone is not in use.
2. Press **▼** or **▲** to scroll to **◆Answering sys**, then press **SELECT**.
3. Press **▼** or **▲** to scroll to **◆Ans sys setup**, then press **SELECT**.
4. Press **SELECT** to select **◆Call screening**.
5. Press **▼** or **▲** to select **◆Screening: On** or **◆Screening: Off**.
6. Press **SELECT** to save and you hear a confirmation tone.

Turn the message alert tone on or off

When the message alert tone is set to on, and there is at least one new message, the telephone base beeps every 10 seconds. The message alert tone is preset to off.

There is no audible alert at the handset.

1. Press **MENU** when the phone is not in use.
2. Press **▼** or **▲** to scroll to **◆Answering sys**, then press **SELECT**.
3. Press **▼** or **▲** to scroll to **◆Ans sys setup**, then press **SELECT**.
4. Press **▼** or **▲** to scroll to **◆Msg alert tone**, then press **SELECT**.
5. Press **▼** or **▲** to select **◆Tone: On** or **◆Tone: Off**.
6. Press **SELECT** to save and you hear a confirmation tone.

NOTES

- The answering system must be turned on for the message alert tone to be functional.
- Press any key on the telephone base (except **FIND HANDSET**) to temporarily silence the message alert tone.

Using your built-in answering system

Message capacity

The answering system can record and store up to 99 messages. Each message can be up to three minutes. The total storage capacity for the announcement, messages and memos is approximately 14 minutes. The actual recording time depends on individual message characteristics. Messages remain available for replay until you delete them.

New message indication

When there are new answering system messages, the handset and the telephone base display **XX new messages**, and the **▶/■/PLAY/STOP** light on the telephone base flashes.

If the message alert tone is turned on, the telephone base beeps every 10 seconds when there are messages that have not been reviewed.

NOTE

After reviewing all new messages, the total number of messages displays on the telephone base screen.

Message playback

If you have new messages, the telephone plays only the new messages (oldest first). If there are no new messages, the telephone plays back all messages (oldest first).

When playback begins, you hear the total number of messages followed by the day and time of the message.

After the last message, the telephone announces, *"End of messages."*

To play messages at the telephone base:

- Press **▶/■/PLAY** when the phone is not in use. When you have no message in the answering system, the telephone base announces, *"You have no message."*

-OR-

1. Press **MENU** when the phone is not in use.
2. Press **SELECT** to select **▶Play messages**. The system plays the messages.

Options during playback:

- Press **▼VOL** or **VOL▲** to adjust the message playback volume.
- Press **▶/SKIP** to skip to the next message.
- Press **◀/REPEAT** to repeat the message. Press **◀/REPEAT** twice to hear the previous message.
- Press **X/DELETE** to delete the playing message. The telephone base displays **Message deleted**. The system announces, *"Message deleted,"* and then advances to the next message.
- Press **STOP** or **5** to stop the playback.

To play messages on a cordless handset:

1. Press **MENU** when the phone is not in use.
2. Press **SELECT** to select **▶Play messages**. The system plays the messages.

Options during playback:

- Press **▼/VOLUME** or **▲/VOLUME** to adjust the message playback volume.
- Press **6** to skip to the next message.
- Press **4** to repeat the message. Press **4** twice to hear the previous message.
- Press **3** or **DELETE** to delete the playing message. The cordless handset displays **Message deleted**. The system announces, *"Message deleted,"* and then advances to the next message.
- Press **OFF** to stop the playback.
- Press **📞** to switch between the speakerphone and the handset earpiece.

Delete all old messages

You can only delete old (reviewed) messages. You cannot delete new messages until you review them. You cannot retrieve deleted messages.

To delete all messages with the telephone base:

1. Press **X/DELETE** when the phone is not in use. The system announces, *"To delete all old messages, press DELETE again."*
2. Press **X/DELETE** immediately. The system announces, *"All old messages deleted."* If you do not have old messages, the system announces, *"You have no old message."*

To delete all old messages with a handset:

1. Press **MENU** when the phone is not in use.
2. Press **▼** or **▲** to scroll to **◆Answering sys**, then press **SELECT**.
3. Press **▼** or **▲** to scroll to **◆Delete all old**, then press **SELECT**. The screen shows **Delete all msg?** If you do not have old messages, the screen displays **No old messages**.
4. Press **SELECT** again to confirm. The screen displays **Deleting...** then **No old messages**. You hear a confirmation tone.

Remote access

A two-digit security code is required to access the answering system remotely from any touch-tone telephone. The preset code is **19**. You can use this preset code, or set your own.

1. Dial your telephone number from any touch-tone telephone.
2. When the system plays your announcement, enter the two-digit security code.
3. Then you can enter one of the following remote commands.

| Command | Description |
|-----------|---|
| 1 | Play all messages. |
| 2 | Play only new messages. |
| 3 | Delete the current message (during playback). |
| 33 | Delete all old messages. |
| 4 | Repeat the current message (during playback). |
| 5 | Stop. |
| *5 | Hear a list of remote commands. |

| Command | Description |
|-----------|---|
| 6 | Skip to the next message (during playback). |
| *7 | Record a new announcement. |
| 8 | End the call. |
| 0 | Turn the answering system on or off. |

4. Hang up or press **8** to end the call.

NOTES

- If you do not press any keys after you enter the remote access code, all new messages play. If there are no new messages, all old messages play.
- Once the new messages have played, the telephone announces the help menu options. If you do not press any key within 20 seconds, the remote access call automatically disconnects.
- When the answering system memory is full, the telephone announces, "*Memory is full. Enter the remote access code.*"
- When the answering system is off, the telephone answers after 10 rings, and announces, "*Please enter your remote access code.*"

Set your remote access code

You can set your own remote access code from **00** to **99**.

1. Press **MENU** when the phone is not in use.
2. Press **▼** or **▲** to scroll to **◆Answering sys**, then press **SELECT**.
3. Press **▼** or **▲** to scroll to **◆Ans sys setup**, then press **SELECT**.
4. Press **▼** or **▲** to scroll to **◆Remote code**, then press **SELECT**.
5. Press **▼** or **▲**, or use the dialing keys (**0-9**) to enter a two-digit number.
6. Press **SELECT** to save and you hear a confirmation tone.

Call screening

If the answering system and call screening are on, the announcement and the incoming message broadcast at the telephone base while the call is answered by the answering system.

Options while a message is being recorded:

- Press **▼ VOL** or **VOL ▲** to adjust the call screening volume.
- Press **▶/■/STOP** to temporarily silence the call screening.
- Press **▶/■/PLAY** or **VOL ▲** to temporarily turn on the call screening if call screening is set to off.

Call intercept

If you want to talk to the caller whose message is being recorded, press **TALK** or **📞** on a cordless handset, or **📞/SPEAKER** on the telephone base, or lift the corded handset from the telephone base.

Temporarily turn off the message alert tone

If the message alert tone is turned on, the telephone base beeps every 10 seconds when there are new messages. Pressing any telephone base key (except **FIND HANDSET** and **📞/ANS ON/OFF**) temporarily silences the message alert tone.

The message alert tone resumes when you receive a new message.

Record, play and delete memos

Memos are your own recorded messages used as reminders for yourself or others using the same answering system. You can record your own memos using a system handset or the telephone base. Play and delete them in the same way as incoming messages.

1. Press **MENU** when the phone is not in use.
2. Press **▼** or **▲** to scroll to **📞Answering sys**, then press **SELECT**.
3. Press **▼** or **▲** to scroll to **📞Record memo**, then press **SELECT**.
4. The system announces, "*Record after the tone. Press 5 when you are done.*" After the tone, speak towards the microphone.
5. To stop recording, press **5** or **OFF** on the cordless handset, or press **5** or **▶/■/STOP** on the telephone base. The system announces, "*Recorded.*"

📞NOTES

- "*Memory is full*" is announced if you record a memo when the memory is full.
- Each memo can be up to three minutes in length.
- Memos shorter than two seconds are not recorded.

Use the built-in answering system and voicemail service

You can use your answering system and voicemail service together by setting your answering system to answer before voicemail service answers as described below. To learn how to program your voicemail settings, contact your telephone service provider.

If you are on a call, or if the answering system is busy recording a message and you receive another call, the second caller can leave a voicemail message.

Set your answering system to answer calls at least two rings earlier than your voicemail is set to answer. For example, if your voicemail answers after six rings, set your answering system to answer after four rings. Some voicemail providers may program the delay before answering calls in seconds instead of rings. In this case, allow six seconds per ring when determining the appropriate setting.

Retrieve voicemail from telephone service

Voicemail is a feature available from most telephone service providers. It may be included with your telephone service, or may be optional. Fees may apply.



Retrieve voicemail

When you received a voicemail, the handset displays  and **New voicemail**. To retrieve, you typically dial an access number provided by your telephone service provider, and then enter a security code. Contact your telephone service provider for instructions on how to configure the voicemail settings and listen to messages.

NOTE

After you have listened to all new voicemail messages, the indicators on the handset turn off automatically.

Voicemail number

If you subscribe to voicemail service offered by your telephone service provider, you can save the voicemail number to  **1** on each handset and the telephone base for easy access. When you want to retrieve voicemail messages, press and hold  **1**.

To save and dial your voicemail number:

1. Press and hold  **1** when the phone is not in use.
2. Use the dialing keys to enter the voicemail access number provided by your telephone service provider (up to 30 digits) when prompted.
 - Press **▼** or **▲** to move the cursor to the left or right.
 - Press **DELETE** to erase a digit.

- Press and hold **DELETE** on the handset to erase all digits.
 - Press and hold **PAUSE** to enter a dialing pause (a **P** appears).
3. Press **SELECT** to save. Then, the handset/telephone base dials the saved voicemail number.

To save your voicemail number:

1. Press **MENU** when the handset/telephone base is not in use.
2. Press ▼ or ▲ to scroll to **Settings**, then press **SELECT**.
3. Press ▼ or ▲ to scroll to **Voicemail #**, then press **SELECT**.
4. Use the dialing keys to enter the voicemail number (up to 30 digits).
 - Press ▼ or ▲ to move the cursor to the left or right.
 - Press **DELETE** to erase a digit.
 - Press and hold **DELETE** on the handset to erase all digits.
 - Press and hold **PAUSE** to enter a dialing pause (a **P** appears).
5. Press **SELECT** to save your selection and return to the previous menu. You hear a confirmation tone and the screen displays **VM # saved**.

Turn off the new voicemail indicators

If you have retrieved your voicemail while away from home, and the handset still displays the new voicemail indicators, use this feature to turn off the indicators.

NOTE

This feature turns off the indicators only, it does not delete your voicemail messages.

1. Press **MENU** when the handset/telephone base is not in use.
2. Press ▼ or ▲ to scroll to **Settings**, then press **SELECT**.
3. Press ▼ or ▲ to scroll to **Clear voicemail #**, then press **SELECT**. The screen displays **Reset VM Icon?**
4. Press **SELECT** to save your selection and return to the previous menu. You hear a confirmation tone.

Other information

Website

Use this feature to view the VTech website address.

1. Press **MENU** when the handset/telephone base is not in use.
2. Press ▼ or ▲ to scroll to **Web address**, then press **SELECT**. The screen displays the VTech website address.

Expand your telephone system

You can add new handsets (**CS6609**, purchased separately) to your telephone system. Your telephone base supports a maximum of five handsets.

For more details, refer to the user's manual that comes with your **CS6609** new handset.

Screen messages

| | |
|-----------------|---|
| Ans sys off | The answering system is turned off and will not answer calls. |
| Ans sys on | The answering system is turned on and will answer calls. |
| Base is calling | The telephone base is calling the handset. |
| Call log empty | There are no caller ID log entries. |
| Calling base | The handset is calling the base (for intercom calls). The handset is transferring an outside call to the base. |
| Calling HS X | The handset/telephone base is calling another handset (for intercom calls). The handset/telephone base is transferring an outside call to another handset. |
| Check AC Power | The corded handset is in use while the telephone base is in line power mode. |
| Contact deleted | A directory entry is deleted. |
| Directory empty | There are no directory entries. |
| Directory full | The directory is full. You cannot save any new entries unless you delete some current entries. |
| Ended | You have just ended a call. |
| Failed | The handset registration is not successful. |
| HS X is calling | Another system handset is calling (for intercom calls). |

| | |
|-----------------|--|
| Incoming call | There is a call coming in. |
| Intercom | The system device is on an intercom call. |
| Intercom ended | The intercom call has just ended. |
| Intercom to | You have started the intercom process, and need to enter the device number you wish to call. |
| Line in use | An extension phone, or one of the handsets is in use. |
| Low battery | The handset battery needs to be recharged. |
| Microphone on | The mute function is turned off and the other party can hear you. |
| Muted | The microphone is off. The other party cannot hear you but you can hear them. |
| New voicemail | There are new voicemail messages from your telephone service provider. |
| NO BATTERY | The handset in the handset charger has no battery installed. |
| No line | There is no telephone line connected. |
| No message | There is no message recorded in the answering system. |
| Not available | Someone else is using the directory, caller ID log history or the answering system. |
| Number repeated | The telephone number you have entered is already in the directory. |

| | |
|--------------------------------|---|
| Out of range or no PWR at base | The handset has lost connection to the telephone base. |
| Outside call | You are on the external call during call transfer. |
| Phone | The handset/ telephone base is on a call. |
| PRIVATE CALLER | The caller is blocking the name and number information. |
| PRIVATE NAME | The caller is blocking the name information. |
| PRIVATE NUMBER | The caller is blocking the telephone number information. |
| Put in charger | The handset battery is very low. Put the handset in the handset charger for recharging. |
| Quiet mode on | The quiet mode is turned on. |
| Quiet mode off | The quiet mode is turned off. |
| Rec mem full | The system recording time is full. |
| Recording... | The answering system is recording a message or memo. |
| Registered | The handset is successfully registered to the telephone base. |
| Registering... | The handset is registering to the telephone base. |
| Ringer muted | The ringer is muted temporarily when it is ringing. |
| Ringer off | The ringer is turned off. |

| | |
|------------------------------|--|
| Saved | Your selection has been saved. |
| Speaker | The speakerphone is in use. |
| To register HS See manual | Screen display on a non-registered handset. |
| Transferred | You have transferred an outside call to another cordless handset or the telephone base. |
| Unable to call | Failed phone call (the telephone line is in use). Failed intercom or conference call (there are already two handsets being used). The handset is out of range while on a call. |
| UNKNOWN CALLER | No information is available about this caller. |
| UNKNOWN NAME | This caller's name is unavailable. |
| UNKNOWN NUMBER | This caller's number is unavailable. |
| XX missed calls | There are new calls in the caller ID log. |
| XX new messages | There are new messages in the answering system. |
| ** Paging ** | The telephone base is paging all handsets. |

General product care

Taking care of your telephone

Your cordless telephone contains sophisticated electronic parts, so it must be treated with care.

Avoid rough treatment

Place the handset down gently. Save the original packing materials to protect your telephone if you ever need to ship it.

Avoid water

Your telephone can be damaged if it gets wet. Do not use the handset outdoors in the rain, or handle it with wet hands. Do not install the telephone base near a sink, bathtub or shower.

Electrical storms

Electrical storms can sometimes cause power surges harmful to electronic equipment. For your own safety, take caution when using electrical appliances during storms.

Cleaning your telephone

Your telephone has a durable plastic casing that should retain its luster for many years. Clean it only with a dry non-abrasive cloth. Do not use dampened cloth or cleaning solvents of any kind.

Frequently asked questions

Below are the questions most frequently asked about the cordless telephone. If you cannot find the answer to your question, visit our website at

www.vtechphones.com or call

1 (800) 595-9511 for customer service.

In Canada, go to

www.vtechcanada.com or dial

1 (800) 267-7377.

| | |
|---|---|
| My telephone does not work at all. | Make sure the telephone base is installed properly, and battery is installed and charged correctly. For optimum daily performance, return the handset to the telephone base after use. |
| The display shows No line . I cannot hear the dial tone. | Disconnect the telephone line cord from your telephone and connect it to another telephone. If there is no dial tone on that other telephone either, then the telephone line cord may be defective. Try installing a new telephone line cord. If changing the telephone line cord does not help, the wall jack (or the wiring to this wall jack) may be defective. Contact your telephone service provider. You may be using a new cable or VoIP service, the existing telephone jacks in your home may no longer work. Contact your service provider for solutions. |
| I cannot dial out. | Make sure there is a dial tone before dialing. It is normal if the handset takes a second or two to synchronize with the telephone base before producing a dial tone. Wait an extra second before dialing. |

| | | | |
|--|---|--|--|
| I cannot dial out. | Eliminate any background noise. Mute the handset before dialing, or dial from another room in your home with less background noise. | I hear other calls when using the telephone. | Disconnect the telephone base from the telephone wall jack. Plug in a different telephone. If you still hear other calls, the problem is probably in the wiring or telephone service. Contact your telephone service provider. |
| The display shows To register HS and See manual alternately. The handset does not work at all. | <p>The handset is deregistered from the telephone base. To register it back:</p> <ol style="list-style-type: none"> 1. Press and hold FIND HANDSET on the telephone base for about four seconds until the IN USE light turns on and it shows Registering... 2. Press QUIET# on the handset. The handset shows Registering... Both the telephone base and cordless handset show Registered, and you hear a beep when the registration process completes. This process takes about 60 seconds. <p>If registration fails, the handset displays Failed. Repeat steps 1 to 2 again.</p> | I hear noise on the cordless handset and the keys do not work. | Make sure the telephone line cord is plugged in securely. |
| The display shows Low battery . | Place the handset in the telephone base or charger for charging. | There is interference during a telephone conversation. My calls fade out when I am using the cordless handset. | The handset may be out of range. Move it closer to the telephone base. |
| The battery does not charge in the handset or the handset battery does not accept charge. | <p>Make sure the handset is placed in the telephone base or charger correctly.</p> <p>If the battery is completely depleted, charge the battery for at least 30 minutes before use.</p> <p>You may need to purchase a new battery.</p> | | If you subscribe to high-speed Internet service (DSL - digital subscriber line) through your telephone line, you must install a DSL filter between the telephone line cord and the telephone wall jack. The filter prevents noise and caller ID problems caused by DSL interference. Contact your DSL service provider for more information about DSL filters. |
| The telephone does not ring when there is an incoming call. | <p>Make sure the ringer volume is not set to off.</p> <p>The handset may be too far from the telephone base. Move it closer to the telephone base.</p> | | Appliances or other cordless telephones plugged into the same circuit as the telephone base can cause interference. Try moving the appliance or telephone base to another outlet. |
| My handset beeps and is not performing normally. | Move the handset closer to the telephone base. It may be out of range. | | The location of your telephone base can impact the performance of your cordless phone. For better reception, install the telephone base in a centralized location within your home or office, away from walls or other obstructions. In many environments, elevating the telephone base improves overall performance. |

| | |
|--|---|
| The telephone does not receive caller ID or the telephone does not show caller ID during call waiting. | Caller ID is a subscription service. You must subscribe to this service from your telephone service provider for this feature to work on your telephone. |
| | Both your and the caller's telephone service providers must use equipment compatible with the caller ID service. |
| | The caller may not be calling from an area which supports caller ID. |
| | The caller ID information displays after the first or second ring. |
| The display shows Out of range or no pwr at base. | The handset may be out of range. Move it closer to the telephone base. |
| | Make sure the power cord is securely plugged into the telephone base. Use a working electrical outlet not controlled by a wall switch. |
| I cannot hear any instruction from the handset when I try to record, play or delete my own announcement. | The handset does not have a speakerphone. When recording, playing or deleting your own announcement, the instructions are announced through the handset receiver. Make sure you place the handset receiver close to your ear. |
| The outgoing announcement is not clear. | When recording the announcement, make sure you speak in a normal tone of voice towards the microphone of the handset. |
| | Make sure there is no background noise when recording. |

| | |
|--|--|
| The answering system does not record messages. | Make sure the answering system is on. When the answering system is on, ANS ON should display on the handset and the telephone base. |
| | When the answering machine memory is full, it does not record new messages until some old messages are deleted. |
| | If you subscribe to voicemail service, change the number of rings so that your answering system answers before your voicemail service answers. To determine how many rings activate your voicemail service, contact your telephone service provider. |
| The answering system does not announce the correct day of the week for recorded messages time stamp. | Make sure you have set the date and time. See Configure your telephone section. |
| The messages on the answering system are very difficult to hear. | Press VOL+ on the handset or ▲/VOLUME on the telephone base to increase the listening volume. |
| The messages on the answering system are incomplete. | If a caller leaves a very long message, part of it may be lost when the answering system disconnects the call after the preset recording time. |
| | If the memory on the answering system becomes full during a message, the answering system stops recording and disconnects the call. |
| | If the caller's voice is very soft, the answering system may stop recording and disconnect the call. |

| | |
|--|---|
| The answering system does not respond to remote commands. | Make sure you enter the correct remote access code. |
| | Make sure you are calling from a touch-tone telephone. When dialing a number, there should be tones. If there are clicks, then it is not a touch-tone telephone and cannot activate the answering system. |
| | The answering system may not detect the remote access code when your announcement is playing. Wait until the announcement is over before entering the code. |
| I subscribe to a nontraditional telephone service that uses my computer to establish connections, and my telephone doesn't work. | Make sure your computer is powered on, and your Internet is working properly. |
| | Make sure to plug your USB telephone adapter into a dedicated USB port on your computer. Do not plug into a multiple port USB hub (USB splitter) that is not powered. |
| | In a few rare instances, the USB port on your computer may not have enough power. In these instances, try using a USB hub with its own external power supply. |
| | If you are using a firewall, it may prevent access to your nontraditional telephone service. Contact your service provider for more information. |
| I accidentally set my LCD language to Spanish or French, and I don't know how to change it back to English. | While the handset is not in use, press MENU and then enter X 364# to change the handset LCD language back to English. |

The RBRC® seal

The RBRC® seal on the nickel-metal hydride battery indicates that VTech Communications, Inc. is voluntarily participating in an industry program to collect and recycle these batteries at the end of their useful lives, when taken out of service within the United States and Canada.

The RBRC® program provides a convenient alternative to placing used nickel-metal hydride batteries into the trash or municipal waste, which may be illegal in your area.

VTech's participation in RBRC® makes it easy for you to drop off the spent battery at local retailers participating in the RBRC® program or at authorized VTech product service centers. Please call **1 (800) 8 BATTERY®** for information on Ni-MH battery recycling and disposal bans/restrictions in your area. VTech's involvement in this program is part of its commitment to protecting our environment and conserving natural resources.

RBRC® and 1 (800) 8 BATTERY® are registered trademarks of the Rechargeable Battery Recycling Corporation.



FCC, ACTA and IC regulations

FCC Part 15

This equipment has been tested and found to comply with the requirements for a Class B digital device under Part 15 of the Federal Communications Commission (FCC) rules. These requirements are intended to provide reasonable protection against harmful interference in a residential installation. This equipment generates, uses and can radiate radio frequency energy and, if not installed and used in accordance with the instructions, may cause harmful interference to radio communications. However, there is no guarantee that interference will not occur in a particular installation. If this equipment does cause harmful interference to radio or television reception, which can be determined by turning the equipment off and on, the user is encouraged to try to correct the interference by one or more of the following measures:

- Reorient or relocate the receiving antenna.
- Increase the separation between the equipment and receiver.
- Connect the equipment into an outlet on a circuit different from that to which the receiver is connected.
- Consult the dealer or an experienced radio/TV technician for help.

Changes or modifications to this equipment not expressly approved by the party responsible for compliance could void the user's authority to operate the equipment.

This device complies with Part 15 of the FCC rules. Operation is subject to the following two conditions: (1) this device

may not cause harmful interference, and (2) this device must accept any interference received, including interference that may cause undesired operation. Privacy of communications may not be ensured when using this telephone.

To ensure safety of users, the FCC has established criteria for the amount of radio frequency energy that can be safely absorbed by a user or bystander according to the intended usage of the product. This product has been tested and found to comply with the FCC criteria. The handset may be safely held against the ear of the user. The telephone base shall be installed and used such that parts of the user's body other than the hands are maintained at a distance of approximately 20 cm (8 inches) or more.

This Class B digital apparatus complies with Canadian requirement:
CAN ICES-3 (B)/NMB-3(B).

FCC Part 68 and ACTA

This equipment complies with Part 68 of the FCC rules and with technical requirements adopted by the Administrative Council for Terminal Attachments (ACTA). The label on the back or bottom of this equipment contains, among other things, a product identifier in the format US:AAAEQ##TXXXX. This identifier must be provided to your telephone service provider upon request.

The plug and jack used to connect this equipment to premises wiring and the telephone network must comply with applicable Part 68 rules and technical requirements adopted by ACTA. A compliant telephone cord and modular

plug is provided with this product. It is designed to be connected to a compatible modular jack that is also compliant. An RJ11 jack should normally be used for connecting to a single line and an RJ14 jack for two lines. See the installation instructions in the user's manual.

The Ringer Equivalence Number (REN) is used to determine how many devices you may connect to your telephone line and still have them ring when you are called. The REN for this product is encoded as the 6th and 7th characters following the US: in the product identifier (e.g., if ## is 03, the REN is 0.3). In most, but not all areas, the sum of all RENs should be five (5.0) or less. For more information, contact your telephone service provider.

This equipment may not be used with Party Lines. If you have specially wired alarm dialing equipment connected to your telephone line, ensure the connection of this equipment does not disable your alarm equipment. If you have questions about what will disable alarm equipment, consult your telephone service provider or a qualified installer.

If this equipment is malfunctioning, it must be unplugged from the modular jack until the problem has been corrected. Repairs to this telephone equipment can only be made by the manufacturer or its authorized agents. For repair procedures, follow the instructions outlined under the Limited warranty.

If this equipment is causing harm to the telephone network, the telephone service provider may temporarily discontinue your telephone service. The telephone service provider is required to notify you before interrupting service. If advance notice is not practical, you will be notified

as soon as possible. You will be given the opportunity to correct the problem and the telephone service provider is required to inform you of your right to file a complaint with the FCC. Your telephone service provider may make changes in its facilities, equipment, operation, or procedures that could affect the proper functioning of this product. The telephone service provider is required to notify you if such changes are planned.

If this product is equipped with a corded or cordless handset, it is hearing aid compatible.

If this product has memory dialing locations, you may choose to store emergency telephone numbers (e.g., police, fire, medical) in these locations. If you do store or test emergency numbers, please:

Remain on the line and briefly explain the reason for the call before hanging up. Perform such activities in off-peak hours, such as early morning or late evening.

Industry Canada

This device complies with Industry Canada licence-exempt RSS standard(s).

Operation is subject to the following two conditions: (1) this device may not cause harmful interference, and (2) this device must accept any interference received, including interference that may cause undesired operation.

Privacy of communications may not be ensured when using this telephone.

The term "IC:" before the certification/ registration number only signifies that the Industry Canada technical specifications were met.

The Ringer Equivalence Number (REN) for this terminal equipment is 1.0. The

REN is an indication of the maximum number of devices allowed to be connected to a telephone interface. The termination on an interface may consist of any combination of devices subject only to the requirement that the sum of the RENs of all the devices does not exceed five.

This product meets the applicable Industry Canada technical specifications.

California Energy Commission battery charging testing instructions

This telephone is set up to comply with the energy-conserving standards right out of the box. These instructions are intended for California Energy Commission (CEC) compliance testing only. When the CEC battery charging testing mode is activated, all telephone functions, except battery charging, will be disabled.

To activate the CEC battery charging testing mode:

1. Unplug the telephone base power adapter from the power outlet. Make sure all handsets are plugged with charged batteries before proceeding.
2. While you press and hold **FIND HANDSET**, plug the telephone base power adapter back to the power outlet.
3. After about 10 seconds, when the **IN USE** light starts flashing and the telephone base shows **Registering...** and then **De-register?**, release **FIND HANDSET** and immediately press and release **SELECT**. The telephone base displays **Please wait**.

NOTE

- When the phone successfully enters the CEC battery charging testing mode, all handsets display **To register HS** and **See manual** alternatively.
- When the phone fails to enter this mode, repeat Step 1 through Step 3 above.

To deactivate the CEC battery charging testing mode:

1. Unplug the telephone base power adapter from the power outlet, then plug it back in. Then, the telephone base is powered up as normal.
2. Press and hold **FIND HANDSET** on the telephone base for about four seconds until the **IN USE** light turns on and it shows **Registering...**

3. Press **QUIET#** on the handset. The handset shows **Registering...** Both the telephone base and cordless handset show **Registered**, and you hear a beep when the registration process completes. This process takes about 60 seconds.

 **NOTE**

- If registration fails, the handset displays **Failed**. Repeat steps 1 to 3 again.

For C-UL compliance only

Mesures de sécurité importantes

Afin de réduire les risques d'incendie, de blessures corporelles ou d'électrocution, suivez toujours ces mesures préventives de base lorsque vous utilisez votre téléphone :

1. Lisez et comprenez bien toutes les instructions.
2. Observez toutes les instructions et mises en garde inscrites sur l'appareil.
3. Débranchez ce téléphone de la prise murale avant de le nettoyer. N'utilisez pas de nettoyeurs liquides ni en aérosol. N'utilisez qu'un chiffon doux et légèrement humecté.
4. N'utilisez pas ce produit près de l'eau, tel que près d'un bain, d'un lavabo, d'un évier de cuisine, d'un bac de lavage ou d'une piscine, ou dans un sous-sol humide ou sous la douche.
5. Ne déposez pas ce téléphone sur un chariot, support ou table chancelants. L'appareil pourrait tomber et être sérieusement endommagé.
6. Évitez d'installer le système téléphonique dans les endroits soumis à une température extrême, à la lumière directe du soleil ou à proximité immédiate d'autres appareils électriques ou électroniques. Protégez votre téléphone contre les sources d'humidité, la poussière, les vapeurs et les liquides corrosifs.
7. Le boîtier de l'appareil est doté de fentes et d'ouvertures d'aération situées à l'arrière ou en dessous. Afin d'empêcher la surchauffe, ces

- ouvertures ne doivent pas être obstruées en plaçant l'appareil sur un lit, divan, tapis ou autre surface similaires. Ne placez pas cet appareil à proximité d'un élément de chauffage ni d'une plinthe électrique. De plus, ne l'installez pas dans une unité murale ou un cabinet fermé qui ne possède pas d'aération adéquate.
8. Ne faites fonctionner cet appareil qu'avec le type d'alimentation indiqué sur les étiquettes de l'appareil. Si vous ne connaissez pas le voltage de votre maison, consultez votre marchand ou votre fournisseur d'électricité.
 9. Ne déposez rien sur le cordon d'alimentation. Installez cet appareil dans un endroit sécuritaire, là où personne ne pourra trébucher sur la ligne d'alimentation ni le cordon téléphonique modulaire.
 10. N'insérez jamais d'objets à travers les fentes et ouvertures de cet appareil, car ils pourraient toucher à des points de tension dangereux ou court-circuiter des pièces, ce qui constituerait un risque d'incendie ou d'électrocution. N'échappez pas de liquides dans l'appareil.
 11. Afin de réduire les risques d'électrocution, ne démontez pas l'appareil, mais apportez-le plutôt à un centre de service qualifié s'il doit être réparé. En enlevant le couvercle, vous vous exposez à des tensions dangereuses ou autres dangers similaires. Un remontage inadéquat peut être à l'origine d'une électrocution lors d'une utilisation ultérieure de l'appareil. Débranchez l'appareil avant de procéder au nettoyage. Utilisez un chiffon humide et doux.
 12. Ne surchargez pas les prises de courant et les rallonges
 13. Débranchez cet appareil de la prise de courant et communiquez avec le département de service à la clientèle de VTech dans les cas suivants :
 - Lorsque le cordon d'alimentation est endommagé ou écorché.
 - Si du liquide a été échappé dans l'appareil.
 - Si l'appareil a été exposé à une source d'humidité telle que la pluie ou l'eau.
 - Si le produit ne fonctionne pas normalement en respectant les instructions de fonctionnement. Réglez uniquement les commandes indiquées dans les instructions de fonctionnement. Les réglages incorrects des autres commandes pourraient provoquer un dommage qui pourrait exiger un travail exhaustif de la part d'un technicien autorisé afin de rétablir le fonctionnement normal de l'appareil.
 - Si le produit a été échappé et que le socle et/ou le combiné a été endommagé.
 - Si le produit affiche une nette diminution de sa performance.
 14. Évitez d'utiliser un téléphone (autre qu'un sans fil) pendant un orage. Les éclairs peuvent être à l'origine d'une électrocution.
 15. N'utilisez pas le téléphone pour rapporter une fuite de gaz à proximité de la fuite. En certaines circonstances, une flammèche pourrait être provoquée lorsque l'adaptateur est branché à une prise de courant, ou lorsque le combiné est déposé sur le socle.

Ceci est un événement commun associé à la fermeture d'un circuit électrique. L'utilisateur ne devrait pas brancher le téléphone à une prise de courant, et ne devrait pas déposer le combiné chargé sur le socle, si le téléphone se trouve à proximité d'un endroit comportant des concentrations de gaz inflammables, à moins que la ventilation soit adéquate. Une flammèche dans un tel endroit pourrait provoquer un incendie ou une explosion. De tels environnements peuvent comprendre: des endroits où l'on utilise de l'oxygène médical sans ventilation adéquate; des gaz industriels (dissolvants de nettoyage, des vapeurs d'essence, etc.); une fuite de gaz naturel, etc.

16. Ne placez que le combiné de votre téléphone près de votre oreille lorsqu'en mode de conversation.
17. Ces adaptateurs ont été conçus pour être orientés en position verticale ou montés au sol. Les broches ne sont pas conçues pour maintenir l'adaptateur en place si celui-ci est barché dans une prise au plafond ou sous une table/ armoire.

CONSERVEZ CES INSTRUCTIONS

Pile

- **MISE EN GARDE** : N'utilisez que la pile incluse.
- Ne jetez pas la pile au feu. Vérifiez les instructions spécifiques de mise aux rebus auprès des autorités locales.
- N'ouvrez pas et ne mutilez pas la pile. L'électrolyte qui s'en échapperait est corrosif et pourrait causer des brûlures ou des blessures aux yeux ou à la peau. L'électrolyte est toxique si avalé.

- Soyez prudents lorsque vous manipulez les piles afin d'éviter les courts-circuits provoqués par des matériaux conducteurs.
- Rechargez la pile incluse avec cet appareil, selon les instructions et limites spécifiées dans ce guide d'utilisation.

Stimulateurs cardiaques implantés dans l'organisme

Les simulateurs cardiaques (s'applique uniquement aux téléphones numériques sans fil) :

L'organisme 'Wireless Technology Research, LLC (WTR)', une firme de recherche indépendante, a mené une évaluation pluridisciplinaire des interférences entre les téléphones sans fil portatifs et les stimulateurs cardiaques implantés dans l'organisme. Appuyée par l'Administration des aliments et drogues (FDA) des États-Unis, la firme WTR recommande aux médecins :

Avis aux détenteurs de stimulateurs cardiaques

- Ils doivent tenir le téléphone sans fil à une distance d'au moins six pouces du stimulateur cardiaque.
- Ils ne doivent PAS placer le téléphone sans fil directement sur le stimulateur cardiaque, tel que dans une poche de chemise, lorsque celui-ci est en marche.
- Ils doivent utiliser le téléphone sans fil en l'appuyant sur l'oreille qui se trouve dans la direction opposée au stimulateur cardiaque.

L'étude effectuée par l'organisme WRS n'a pas identifié de risque pour les détenteurs de simulateurs cardiaques causés par les gens qui utilisent un téléphone sans fil à proximité de ceux-ci.

À propos des téléphones sans fil

- **Confidentialité** : Les mêmes caractéristiques qui constituent des avantages pour les téléphones sans fil affichent également des restrictions. Les appels téléphoniques sont transmis entre le combiné sans fil et le socle par le biais d'ondes radio ; il y a donc la possibilité que vos conversations téléphoniques sans fil soient interceptées par des équipements de réception radio se trouvant dans la portée du combiné sans fil. Pour cette raison, vous ne devez pas percevoir les communications téléphoniques sans fil comme étant aussi confidentielles que celles des téléphones à cordons.
- **Alimentation électrique** : Le socle de ce téléphone sans fil doit être branché à une prise électrique fonctionnelle. La prise électrique ne doit pas être contrôlée par un interrupteur mural. Les appels ne pourront pas être effectués du combiné sans fil si le socle est débranché ou mis hors tension ou si le courant est coupé.
- **Possibilité d'interférences aux téléviseurs** : Certains téléphones sans fil fonctionnent sur des fréquences pouvant causer des interférences aux téléviseurs et aux magnétoscopes. Pour réduire ou prévenir de telles interférences, ne placez pas le socle du téléphone sans fil près ou sur un téléviseur ou magnétoscope. S'il y a présence de parasites, il est conseillé d'éloigner le téléphone sans fil du téléviseur ou du magnétoscope afin de réduire possiblement les interférences.
- **Piles rechargeables** : Manipulez les piles avec soin afin de ne pas les court-circuiter avec des bagues, bracelets ou clés. Les piles ou le conducteur peut surchauffer et causer des blessures. Respectez la polarité adéquate entre la pile et le chargeur.
- **Les bloc-piles rechargeables à l'hydrure métallique de nickel** : Jetez ces blocs-piles de manière écologique et sécuritaire. Ne les incinerez pas et ne les percez pas. Tel que les autres piles de ce type, elles pourraient dégager une matière toxique qui peut causer des blessures corporelles si elles sont brûlées ou percées.

Limited warranty

What does this limited warranty cover?

The manufacturer of this VTech Product warrants to the holder of a valid proof of purchase (“Consumer” or “you”) that the Product and all accessories provided in the sales package (“Product”) are free from defects in material and workmanship, pursuant to the following terms and conditions, when installed and used normally and in accordance with the Product operating instructions. This limited warranty extends only to the Consumer for Products purchased and used in the United States of America and Canada.

What will VTech do if the Product is not free from defects in materials and workmanship during the limited warranty period (“Materially Defective Product”)?

During the limited warranty period, VTech’s authorized service representative will repair or replace at VTech’s option, without charge, a Materially Defective Product. If we repair the Product, we may use new or refurbished replacement parts. If we choose to replace the Product, we may replace it with a new or refurbished Product of the same or similar design. We will retain defective parts, modules, or equipment. Repair or replacement of the Product, at VTech’s option, is your exclusive remedy. VTech will return the repaired or replacement Products to you in working condition. You should expect the repair or replacement to take approximately 30 days.

How long is the limited warranty period?

The limited warranty period for the Product extends for ONE (1) YEAR from the date of purchase. If VTech repairs or

replaces a Materially Defective Product under the terms of this limited warranty, this limited warranty also applies to repaired or replacement Product for a period of either (a) 90 days from the date the repaired or replacement Product is shipped to you or (b) the time remaining on the original one-year warranty; whichever is longer.

What is not covered by this limited warranty?

This limited warranty does not cover:

1. Product that has been subjected to misuse, accident, shipping or other physical damage, improper installation, abnormal operation or handling, neglect, inundation, fire, water or other liquid intrusion;
2. Product that has been damaged due to repair, alteration or modification by anyone other than an authorized service representative of VTech;
3. Product to the extent that the problem experienced is caused by signal conditions, network reliability, or cable or antenna systems;
4. Product to the extent that the problem is caused by use with non-VTech accessories;
5. Product whose warranty/quality stickers, product serial number plates or electronic serial numbers have been removed, altered or rendered illegible;
6. Product purchased, used, serviced, or shipped for repair from outside the United States of America or Canada, or used for commercial or institutional purposes (including but not limited to Products used for rental purposes);
7. Product returned without a valid proof of purchase (see item 2 on the next page); or
8. Charges for installation or set up, adjustment of customer controls,

and installation or repair of systems outside the unit.

How do you get warranty service?

To obtain warranty service in the USA, please visit our website at www.vtechphones.com or call 1 (800) 595-9511. In Canada, go to www.vtechcanada.com or call 1 (800) 267-7377.

NOTE: Before calling for service, please review the user's manual - a check of the Product's controls and features may save you a service call.

Except as provided by applicable law, you assume the risk of loss or damage during transit and transportation and are responsible for delivery or handling charges incurred in the transport of the Product(s) to the service location. VTech will return repaired or replaced Product under this limited warranty. Transportation, delivery or handling charges are prepaid. VTech assumes no risk for damage or loss of the Product in transit. If the Product failure is not covered by this limited warranty, or proof of purchase does not meet the terms of this limited warranty, VTech will notify you and will request that you authorize the cost of repair prior to any further repair activity. You must pay for the cost of repair and return shipping costs for the repair of Products that are not covered by this limited warranty.

What must you return with the Product to get warranty service?

1. Return the entire original package and contents including the Product to the VTech service location along with a description of the malfunction or difficulty; and
2. Include a "valid proof of purchase" (sales receipt) identifying the Product purchased (Product model) and the date of purchase or receipt; and

3. Provide your name, complete and correct mailing address, and telephone number.

Other limitations

This warranty is the complete and exclusive agreement between you and VTech. It supersedes all other written or oral communications related to this Product. VTech provides no other warranties for this Product. The warranty exclusively describes all of VTech's responsibilities regarding the Product. There are no other express warranties. No one is authorized to make modifications to this limited warranty and you should not rely on any such modification.

State/Provincial Law Rights: This warranty gives you specific legal rights, and you may also have other rights, which vary from state to state or province to province.

Limitations: Implied warranties, including those of fitness for a particular purpose and merchantability (an unwritten warranty that the Product is fit for ordinary use) are limited to one year from the date of purchase. Some states/provinces do not allow limitations on how long an implied warranty lasts, so the above limitation may not apply to you. In no event shall VTech be liable for any indirect, special, incidental, consequential, or similar damages (including, but not limited to lost profits or revenue, inability to use the Product or other associated equipment, the cost of substitute equipment, and claims by third parties) resulting from the use of this Product. Some states/provinces do not allow the exclusion or limitation of incidental or consequential damages, so the above limitation or exclusion may not apply to you.

Please retain your original sales receipt as proof of purchase.

Disclaimer and Limitation of Liability

VTech Communications, Inc. and its suppliers assume no responsibility for any damage or loss resulting from the use of this user's manual. VTech Communications, Inc. and its suppliers assume no responsibility for any loss or claims by third parties that may arise through the use of this product.

Company: VTech Communications, Inc.

Address: 9020 SW Washington Square Road - Ste 555 Tigard, OR 97223, United States

Phone: 1 (800) 595-9511 in the U.S. or 1 (800) 267-7377 in Canada

Technical specifications

| | |
|-------------------------|--|
| Frequency control | Crystal controlled PLL synthesizer |
| Transmit frequency | Handset: 1921.536-1928.448 MHz Telephone base: 1921.536-1928.448 MHz |
| Channels | 5 |
| Nominal effective range | Maximum power allowed by FCC and IC. Actual operating range may vary according to environmental conditions at the time of use. |
| Power requirements | Handset: 2.4V Ni-MH battery Telephone base: 6V DC @ 400mA Charger: 6V DC @ 400mA |
| Memory | Directory: 50 memory locations; up to 30 digits and 15 characters Caller ID log: 50 memory locations; up to 24 digits and 15 characters |



Designed to fit your home.
And your life.

VTech Communications, Inc.
A member of THE VTECH GROUP OF COMPANIES.
VTech is a registered trademark of VTech Holdings Limited.
Specifications are subject to change without notice.
© 2019 VTech Communications, Inc.
All rights reserved. 11/19. CS6649-X_WEBCIB_V11.0

