

Go to www.vtechphones.com to register your product for enhanced warranty support and the latest VTech product news.

CS5119
CS5119-15
CS5119-16
CS5119-17
CS5119-18
CS5119-2
CS5119-23

DECT 6.0 cordless telephone



vtech[®]
User's manual

Congratulations

on purchasing your new VTech product. Before using this telephone, please read **Important safety instructions**.

This manual has all the feature operations and troubleshooting necessary to install and operate your new VTech telephone. Please review this manual thoroughly to ensure proper installation and operation of this innovative and feature rich VTech product.

For support, shopping, and everything new at VTech, visit our website at **www.vtechphones.com**. In Canada, please visit **www.vtechcanada.com**.



Telephones identified with this logo have reduced noise and interference when used with most T-coil equipped hearing aids and cochlear implants. The TIA-1083 Compliant Logo is a trademark of the Telecommunications Industry Association. Used under license.



The ENERGY STAR® program (www.energystar.gov) recognizes and encourages the use of products that save energy and help protect our environment. We are proud to mark this product with the ENERGY STAR® label indicating it meets the latest energy efficiency guidelines.

Important safety instructions

When using your telephone equipment, basic safety precautions should always be followed to reduce the risk of fire, electric shock and injury, including the following:

1. Read and understand all instructions.
2. Follow all warnings and instructions marked on the product.
3. Unplug this product from the wall outlet before cleaning. Do not use liquid or aerosol cleaners. Use a damp cloth for cleaning.
4. Do not use this product near water such as near a bath tub, wash bowl, kitchen sink, laundry tub or a swimming pool, or in a wet basement or shower.
5. Do not place this product on an unstable table, shelf, stand or other unstable surfaces.
6. Avoid placing the telephone system in places with extreme temperature, direct sunlight, or other electrical devices. Protect your phone from moisture, dust, corrosive liquids and fumes.
7. Slots and openings in the back or bottom of the telephone base and handset are provided for ventilation. To protect them from overheating, these openings must not be blocked by placing the product on a soft surface such as a bed, sofa or rug. This product should never be placed near or over a radiator or heat register. This product should not be placed in any area where proper ventilation is not provided.
8. This product should be operated only from the type of power source indicated on the marking label. If you

- are not sure of the type of power supply in your home or office, consult your dealer or local power company.
9. Do not allow anything to rest on the power cord. Do not install this product where the cord may be walked on.
 10. Never push objects of any kind into this product through the slots in the telephone base or handset because they may touch dangerous voltage points or create a short circuit. Never spill liquid of any kind on the product.
 11. To reduce the risk of electric shock, do not disassemble this product, but take it to an authorized service facility. Opening or removing parts of the telephone base or handset other than specified access doors may expose you to dangerous voltages or other risks. Incorrect reassembling can cause electric shock when the product is subsequently used.
 12. Do not overload wall outlets and extension cords.
 13. Unplug this product from the wall outlet and refer servicing to an authorized service facility under the following conditions:
 - When the power supply cord or plug is damaged or frayed.
 - If liquid has been spilled onto the product.
 - If the product has been exposed to rain or water.
 - If the product does not operate normally by following the operating instructions. Adjust only those controls that are covered by the operation instructions. Improper adjustment of other controls may result in damage and often requires extensive work by an authorized technician to restore the product to normal operation.
 14. Avoid using a telephone (other than cordless) during an electrical storm. There is a remote risk of electric shock from lightning.
 15. Do not use the telephone to report a gas leak in the vicinity of the leak. Under certain circumstances, a spark may be created when the adapter is plugged into the power outlet, or when the handset is replaced in its cradle. This is a common event associated with the closing of any electrical circuit. The user should not plug the phone into a power outlet, and should not put a charged handset into the cradle, if the phone is located in an environment containing concentrations of flammable or flame-supporting gases, unless there is adequate ventilation. A spark in such an environment could create a fire or explosion. Such environments might include: medical use of oxygen without adequate ventilation; industrial gases (cleaning solvents; gasoline vapors; etc.); a leak of natural gas; etc.
 16. Only put the handset of your telephone next to your ear when it is in normal talk mode.
 17. The power adapter is intended to be correctly oriented in a vertical or floor mount position. The prongs are not designed to hold the plug in place if it is plugged into a ceiling, under-the-table or cabinet outlet.

SAVE THESE INSTRUCTIONS

Battery

- **CAUTION:** Use Only Supplied Battery.
- Do not dispose of the battery in a fire. Check with local waste management codes for special disposal instructions.
- Do not open or mutilate the battery. Released electrolyte is corrosive and may cause burns or injury to the eyes or skin. The electrolyte may be toxic if swallowed.
- Exercise care in handling batteries in order not to create a short circuit with conductive materials.
- Charge the battery provided with this product only in accordance with the instructions and limitations specified in this manual.

Precautions for users of implanted cardiac pacemakers

Cardiac pacemakers (applies only to digital cordless telephones):

Wireless Technology Research, LLC (WTR), an independent research entity, led a multidisciplinary evaluation of the interference between portable wireless telephones and implanted cardiac pacemakers. Supported by the U.S. Food and Drug Administration, WTR recommends to physicians that:

Pacemaker patients

- Should keep wireless telephones at least six inches from the pacemaker.
- Should NOT place wireless telephones directly over the pacemaker, such as in a breast pocket, when it is turned ON.
- Should use the wireless telephone at the ear opposite the pacemaker.

WTR's evaluation did not identify any risk to bystanders with pacemakers from other persons using wireless telephones.

About cordless telephones

- **Privacy:** The same features that make a cordless telephone convenient create some limitations. Telephone calls are transmitted between the telephone base and the cordless handset by radio waves, so there is a possibility that the cordless telephone conversations could be intercepted by radio receiving equipment within range of the cordless handset. For this reason, you should not think of cordless telephone conversations as being as private as those on corded telephones.
- **Electrical power:** The telephone base of this cordless telephone must be connected to a working electrical outlet. The electrical outlet should not be controlled by a wall switch. Calls cannot be made from the cordless handset if the telephone base is unplugged, switched off or if the electrical power is interrupted.
- **Potential TV interference:** Some cordless telephones operate at frequencies that may cause interference to televisions and VCRs. To minimize or prevent such interference, do not place the telephone base of the cordless telephone near or on top of a TV or VCR. If interference is experienced, moving the cordless telephone farther away from the TV or VCR often reduces or eliminates the interference.
- **Rechargeable batteries:** Exercise care in handling batteries in order not to create a short circuit with conducting material such as rings, bracelets and keys. The battery or conductor may overheat and cause harm. Observe proper polarity between the battery and the battery charger.

- **Nickel-metal hydride rechargeable batteries:** Dispose of these batteries in a safe manner. Do not burn or puncture the battery. Like other batteries of this type, if burned or punctured, they could release caustic material which could cause injury.

Table of contents

What's in the box	1	Call waiting	10
Overview	2	Chain dialing.....	10
Telephone base overview	2	Find handset.....	11
Handset overview.....	2	Redial list	11
Charger overview	3	Review a redial list entry	11
Display icons overview	3	Dial a redial list entry	11
Telephone base lights overview	3	Delete a redial list entry.....	11
Handset lights overview	3	Multiple handset use	12
Connect	4	Intercom	12
Connect the telephone base	4	Answer an incoming call during an intercom call.....	12
Connect the charger.....	4	Transfer a call.....	12
Mount the telephone base.....	4	Phonebook	13
Install the battery	5	Add a phonebook entry	13
Check the battery level.....	5	Review a phonebook entry	14
Charge the battery	5	Alphabetical search.....	14
Before use	6	Delete the phonebook entries	14
Set date and time	6	Edit a phonebook entry	15
Check for dial tone	6	Dial a phonebook entry	15
Operating range	7	Caller ID	15
Configure your telephone	7	Review a caller ID log entry	15
Use the handset menu	7	Memory match.....	16
Set language	7	Missed call indicator.....	16
Set date and time	7	View dialing options.....	16
Home area code.....	8	Dial a caller ID log entry	17
Dial mode	8	Save a caller ID log entry to the phonebook	17
Temporary tone dialing.....	8	Delete the caller ID log entries	17
Telephone operations	9	Call block	18
Make a call	9	Block unknown calls.....	18
Predial a call.....	9	Add a call block list entry.....	18
Answer a call.....	9	Review call block list	18
End a call.....	9	Edit a call block list entry.....	18
Speakerphone.....	9	Save a caller ID log entry to the call block list.....	19
Volume	9	Delete a call block list entry.....	19
Mute	10	Mute first ring.....	19
Join a call in progress (for multiple handset models only)	10		

Sound settings.....	20
Key tone	20
Ringer tone.....	20
Ringer volume	20
Temporary ringer silencing	20
Quiet mode.....	20
Retrieve voicemail from telephone service.....	21
Retrieve voicemail	21
Set your voicemail number.....	21
Turn off the new voicemail indicators	21
Expand your telephone system	22
Screen messages	22
ECO mode	24
General product care	24
Frequently asked questions.....	25
The RBRC® seal	27
FCC, ACTA and IC regulations.....	28
California Energy Commission battery charging testing instructions	30
For C-UL compliance only.....	31
Limited warranty.....	34
Technical specifications.....	37

What's in the box

Your telephone package contains the following items. Save your sales receipt and original packaging in the event warranty service is necessary.

NOTE

- To purchase a replacement battery or power adapter, visit our website at www.vtechphones.com or call 1 (800) 595-9511. In Canada, go to www.vtechcanada.com or call 1 (800) 267-7377.

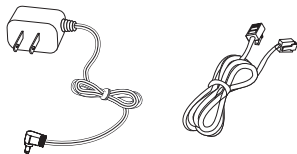
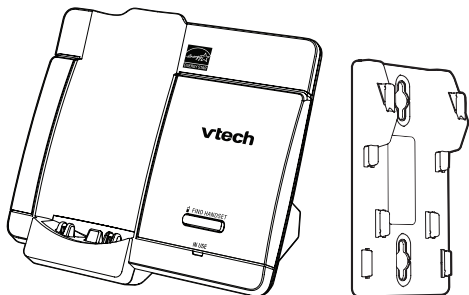

1 set for CS5119/CS5119-15/
CS5119-16/CS5119-17/
CS5119-18/CS5119-2/
CS5119-23

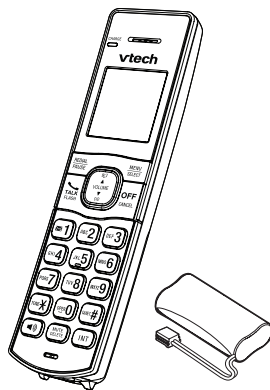

1 set for CS5119/CS5119-15/
CS5119-16/CS5119-17/
CS5119-18
2 sets for CS5119-2/CS5119-23

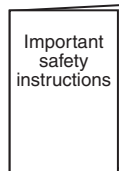
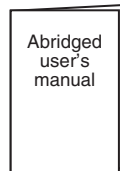

1 set for CS5119/CS5119-15/
CS5119-16/CS5119-17/
CS5119-18/CS5119-2/
CS5119-23

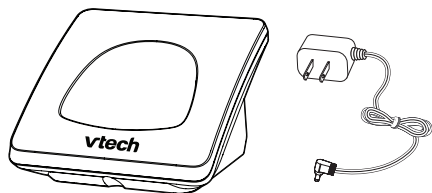

1 set for CS5119-2/CS5119-23

Overview

Telephone base overview

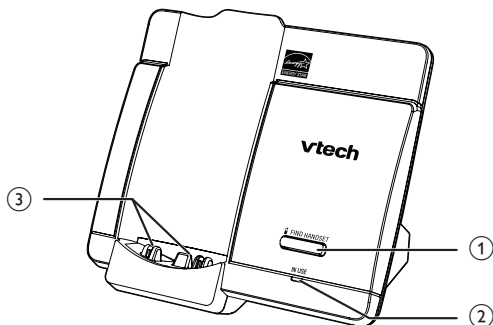

1 – FIND HANDSET

- Page all system handsets.

2 – IN USE light

- Flashes when there is an incoming call, or another telephone sharing the same line is in use.
- On when the telephone is in use.

3 – Charging pole

Handset overview

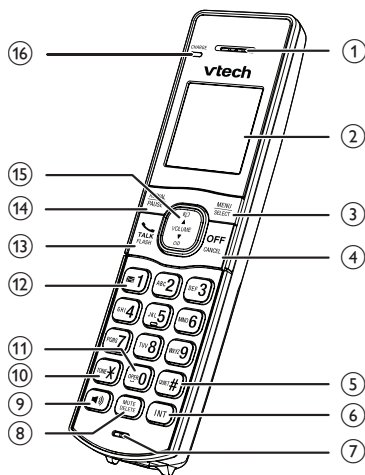

1 – Handset earpiece

2 – LCD display

3 – MENU/SELECT

- Show the menu.
- While in a menu, press to select an item, or save an entry or setting.

4 – OFF/CANCEL

- Hang up a call.
- Return to the previous menu or idle mode without making changes.
- Delete digits while predialing.
- Silence the handset ringer temporarily while the phone is ringing.
- Erase the missed call indicator while the handset is not in use.

5 – QUIET#

- Turn on or off the quiet mode.
- Show other dialing options when reviewing a caller ID log entry.

6 – INT

- Start an intercom conversation or transfer a call (for multi-handset models only).

7 – Microphone

8 – MUTE/DELETE

- Mute the microphone during a call.
- Silence the handset ringer temporarily while the phone is ringing.
- Delete the displayed entry while reviewing the phonebook, caller ID log, call block list or redial list.
- Delete digits or characters when entering numbers or names.

9 –

- Make or answer a call using the handset speakerphone.
- Switch between the handset speakerphone and the handset earpiece during a call.

10 – TONE

- Switch to tone dialing temporarily during a call.

11 – OPER 0

- Enter space character during text editing.

12 – 1

- Press repeatedly to add or remove 1 in front of the caller ID log entry before dialing or saving it to the phonebook.
- Press and hold to set or dial your voicemail number.

13 – TALK/FLASH

- Make or answer a call.
- Answer an incoming call when you receive a call waiting alert.

14 – REDIAL/PAUSE

- Review the redial list.
- Insert a dialing pause while dialing or entering numbers into the phonebook.

15 – ▲/VOLUME/▼ CID

- Review the phonebook or caller ID log when the telephone is not in use.
- Scroll up or down while in a menu, or in the phonebook, caller ID log, call block list or redial list.
- Move the cursor to the left or right when entering numbers or names.
- Adjust the listening volume during a call.

16 – CHARGE light



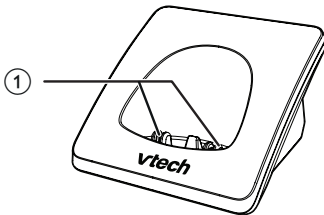

- On when the handset is charging in the telephone base or charger.

Charger overview



1 – Charging pole

Display icons overview

	The battery icon flashes when the battery is low and needs charging.
	The battery icon animates when the battery is charging.
	The battery icon becomes solid when the battery is fully charged.
	The handset ringer is turned off.
	There are new voicemail received from your telephone service provider.
NEW	There are new caller ID log entries.
ECO	The ECO mode activates automatically to reduce power consumption whenever the handset is synchronized with the telephone base.

Telephone base lights overview

IN USE	<ul style="list-style-type: none">• On when the telephone line is in use.• On when you are registering a handset.• Flashes quickly when there is an incoming call.• Flashes when another telephone sharing the same line is in use.• Flashes when you are deregistering all handsets.
---------------	---

Handset lights overview

	On when the handset speakerphone is in use.
CHARGE	On when the handset is charging in the telephone base or charger.

Connect

You can choose to connect the telephone base for desktop usage or wall mounting.

NOTES

- Use only the adapters provided.
- Make sure the electrical outlets are not controlled by wall switches.
- The adapters are intended to be correctly oriented in a vertical or floor mount position. The prongs are not designed to hold the plug in place if it is plugged into a ceiling, under-the-table or cabinet outlet.

TIP

- If you subscribe to digital subscriber line (DSL) high-speed Internet service through your telephone line, make sure you install a **DSL filter** (not included) between the telephone line cord and telephone wall jack. Contact your DSL service provider for more information.

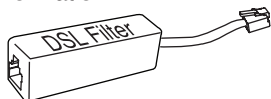

Connect the telephone base

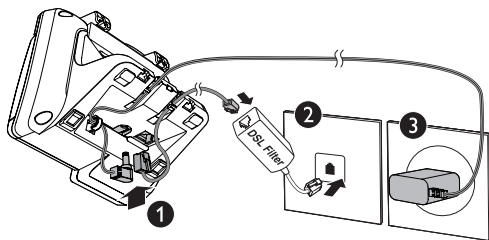

Connect the charger

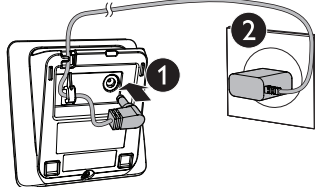

Mount the telephone base

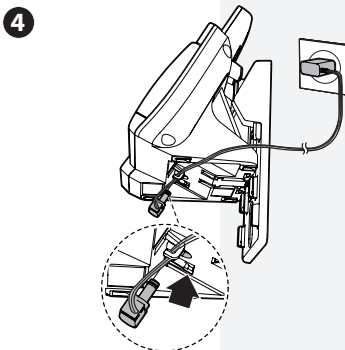
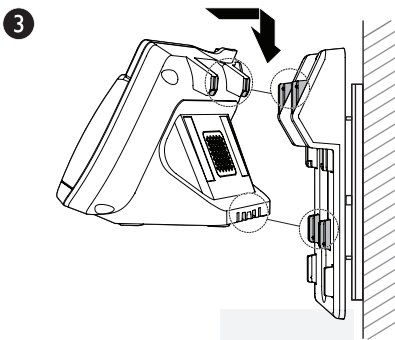
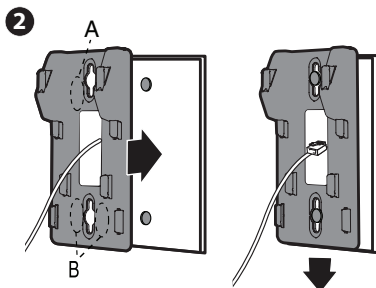
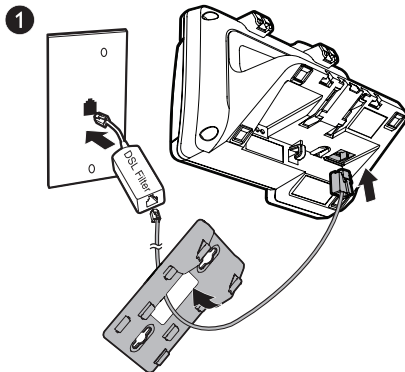

Install the battery

Install the battery as shown below.

NOTES

- Use only supplied battery.
- Charge the battery provided with this product only in accordance with the instructions and limitations specified in this manual.
- If the handset will not be used for a long time, disconnect and remove the battery to prevent possible leakage.

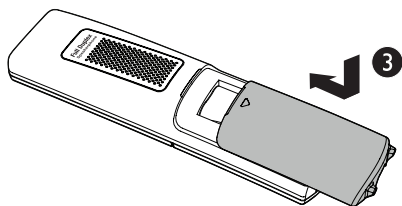
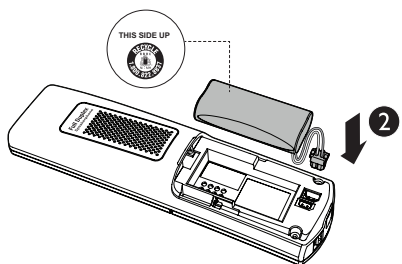
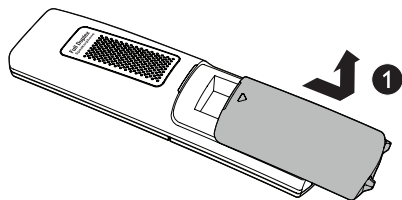

Check the battery level

After you have installed the battery, check the battery level on the handset screen.

- If the battery icon is or or , then go to **Before use** section to set the date and time.
- If the screen is blank, or flashes, then the battery needs to be charged. Go to **Charge the battery** section before you do any setting or operation.

Charge the battery

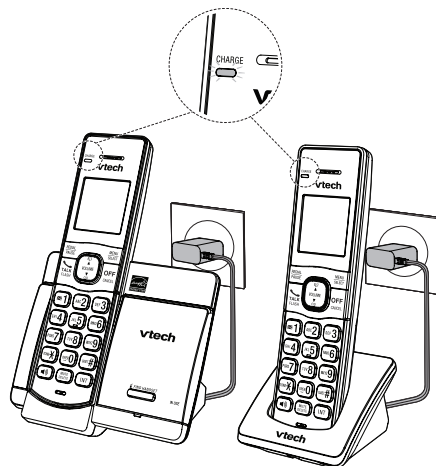

Place the handset in the telephone base or the charger to charge.



Once you have installed the battery, the handset LCD display indicates the battery status (see the table on the next page).

NOTES

- Press **CANCEL** or place the handset in the charger will bypass the set date and time.
- For best performance, keep the handset in the telephone base or charger when not in use.
- The battery is fully charged after 12 hours of continuous charging.
- If you place the handset in the telephone base or the charger without plugging in the battery, the screen displays **No battery**.

Battery indicators	Battery status	Action
The screen is blank, or displays Put in charger and  flashes.	The battery has no or very little charge. The handset cannot be used.	Charge without interruption (at least 30 minutes).
The screen displays Low battery and  flashes.	The battery has enough charge to be used for a short time.	Charge without interruption (about 30 minutes).
The screen displays HANDSET X .	The battery is charged.	To keep the battery charged, place it in the telephone base or charger when not in use.

When the battery is fully charged, you can expect the following performance:

Operation	Operating time
While in use (talking*)	Seven hours
While in speakerphone mode (talking*)	Three and a half hours
While not in use (standby**)	Five days

* Operating times vary depending on your actual use and the age of the battery.

** Handset is not charging nor in use.

To manually set the date and time, refer to **Configure your telephone** section.

Before use

After you install your telephone or power returns following a power outage, the handset will prompt you to set the date and time.

Set date and time

1. Use the dialing keys (**0-9**) to enter the month (**MM**), date (**DD**) and year (**YY**). Then press **SELECT**.
2. Use the dialing keys (**0-9**) to enter the hour (**HH**) and minute (**MM**). Then press **▼** or **▲** to choose **AM** or **PM**.
3. Press **SELECT** to save.

Check for dial tone

Press . If you hear a dial tone, the installation is successful.



If you do not hear a dial tone:

- Make sure the installation procedures described above are properly done.
- It may be a wiring problem. If you have changed your telephone service to digital service from a cable company or a VoIP service provider, the telephone line may need to be rewired to allow all existing telephone jacks to work. Contact your cable/VoIP service provider for more information.

Operating range

This cordless telephone operates with the maximum power allowed by the Federal Communications Commission (FCC). Even so, this handset and telephone base can communicate over only a certain distance - which can vary with the locations of the telephone base and handset, the weather, and the layout of your home or office.

When the handset is out of range, the handset displays **Out of range or no pwr at base**.

If there is a call while the handset is out of range, it may not ring, or if it does ring, the call may not connect well when you press . Move closer to the telephone base, then press  to answer the call.

If the handset moves out of range during a telephone conversation, there may be interference. To improve reception, move closer to the telephone base.

Configure your telephone

Use the handset menu

1. Press **MENU** when the phone is not in use.
2. Press **▼** or **▲** until the screen displays the desired feature menu.
3. Press **SELECT**.
 - To return to the previous menu, press **CANCEL**.
 - To return to idle mode, press and hold **CANCEL**.

Set language

The LCD language is preset to English. You can select English, French or Spanish to be used in all screen displays.

1. Press **MENU** when the handset is not in use.
2. Press **▼** or **▲** to choose **Settings** and then press **SELECT** twice.
3. Press **▼** or **▲** to choose **English**, **Français** or **Español**.
4. Press **SELECT** to save your setting. You hear a confirmation tone.

Set date and time

1. Press **MENU** on the handset when not in use.
2. Press **▼** or **▲** to choose **Set date/time** and then press **SELECT**.
3. Use the dialing keys (**0-9**) to enter the month (**MM**), date (**DD**) and year (**YY**). Then press **SELECT**.
4. Use the dialing keys (**0-9**) to enter the hour (**HH**) and minute (**MM**). Then press **▼** or **▲** to choose **AM** or **PM**.
5. Press **SELECT** to save your setting. You hear a confirmation tone.

Home area code

If you dial local calls using only seven digits (area code not required), you can program your home area code so that when you receive a call within your local area, the telephone number is automatically stored in the caller ID log without the area code.

1. Press **MENU** when the handset is not in use.
2. Press ▼ or ▲ to choose **Settings** and then press **SELECT**.
3. Press ▼ or ▲ to choose **Home area code**, and then press **SELECT**. The screen displays the currently stored home area code.
4. Use the dialing keys (0-9) to enter the desired home area code.
 - Press **DELETE** to delete a digit.
 - Press and hold **DELETE** to delete all digits.
5. Press **SELECT** to confirm. You hear a confirmation tone.

NOTE

- If, in the future, your telephone service provider requires you to dial the area code when making a local call, or, if you move to a location that requires it, delete the home area code you have already programmed following the steps above. After you have deleted the home area code, ___ appears.

Dial mode

The dial mode is preset to touch-tone dialing. If you have pulse (rotary) service, you need to change the dial mode to pulse dialing before using the telephone.

1. Press **MENU** when the handset is not in use.
2. Press ▼ or ▲ to choose **Settings**, and then press **SELECT**.
3. Press ▼ or ▲ to choose **Dial mode**, then press **SELECT**.
4. Press ▼ or ▲ to choose **Touch-tone** or **Pulse**, then press **SELECT** to confirm your selection. You hear a confirmation tone.

Temporary tone dialing

If you have pulse (rotary) service only, you can switch from pulse to touch-tone dialing temporarily during a call. This is useful if you need to send touch-tone signals to access your telephone banking or long distance services.

1. During a call, press **TONEX**.
2. Use the dialing keys to enter the number. The telephone sends touch-tone signals. It automatically returns to pulse dialing mode after you end the call.

Telephone operations

Handset control key panel:

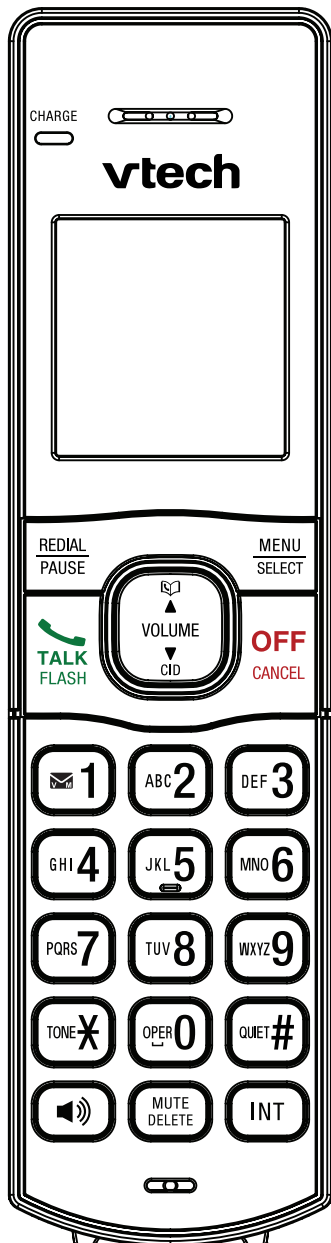

Make a call

- Press **TALK** or **[Speaker Icon]**, and then dial the telephone number.

NOTES

- The screen shows the elapsed time as you talk (in hours, minutes and seconds).
- While entering numbers, press and hold PAUSE to insert a dialing pause (a **P** appears).

Predial a call

- Enter the telephone number using the dialing keys (**0-9**), then press **TALK** or **[Speaker Icon]** to dial.

NOTE

- When predialing (preview numbers before dialing), press **DELETE** or **CANCEL** to backspace and delete; press and hold PAUSE to insert a dialing pause (a **P** appears).

Answer a call

- Press **TALK**, **[Speaker Icon]** or any of the dialing key.

End a call

- Press **OFF** or put the handset back in the telephone base or charger.

Speakerphone

During a call, press **[Speaker Icon]** to switch between speakerphone and normal handset use.

When the speakerphone is active, the handset displays **Speaker**.

Volume

- During a call, press **▲/VOLUME/▼** to adjust the listening volume.

Mute

The mute function allows you to hear the other party but the other party cannot hear you.

- During a call, press **MUTE**. The handset displays **Muted**.
- Press **MUTE** again to resume the conversation. The handset displays **Microphone on** briefly.

Join a call in progress (for multiple handset models only)

You can use up to four handsets at a time on an outside call.

- When a handset is already on a call, press **TALK** or  on another handset to join the call.
- To exit the call, press **OFF** or place the handset in the telephone base or charger. The call continues until both handsets hang up.

Call waiting

When you subscribe to call waiting service from your telephone service provider, you hear an alert tone if there is an incoming call while you are already on a call.

- Press **FLASH** to put the current call on hold and take the new call.
- Press **FLASH** at any time to switch back and forth between calls.

If you also subscribe to caller ID service, it will let you see the name and telephone number of the caller during call waiting.

It may be necessary to change your telephone service to use this feature. Contact your telephone service provide if:

- You have both caller ID and call waiting, but as separate service (you may need to combine these service);

- You have only caller ID service, or only call waiting service; or
- You do not subscribe to caller ID or call waiting services.

There are fees for caller ID services. In addition, services may not be available in all areas.

Chain dialing

Use this feature to initiate a dialing sequence from numbers stored in the phonebook, caller ID log or redial list while you are on a call.

Chain dialing can be useful if you wish to access other numbers (such as bank account numbers or access codes) from the phonebook, caller ID log or redial list.

To access a number in the phonebook while on a call:

1. Press **MENU** twice to enter the phonebook.
2. Press **▼** or **▲** to scroll to the desired entry.
3. Press **SELECT** to dial the displayed number.

To access a number in the caller ID log while on a call:

1. Press **MENU** and then press **▼** or **▲** to select **Caller ID log**.
2. Press **SELECT** and then press **▼** or **▲** to scroll to the desired entry.
3. Press **SELECT** to dial the displayed number.

To access a number in the redial list while on a call:

1. Press **REDIAL**.
2. Press **▼**, **▲** or **REDIAL** repeatedly to browse to the desired entry.
3. Press **SELECT** to dial the displayed number.

- You cannot edit a phonebook entry while on a call. Refer to the **Phonebook** section for more details.
- You cannot copy a caller ID log entry into the phonebook while on a call. Refer to the **Caller ID log** section for more details.
- You cannot erase a redial entry while on a call. Refer to the **Redial list** section for more details.
- Press **CANCEL** to exit redial list, phonebook or caller ID log when you are on a call.



Find handset

Use this feature to find all system handsets.

To start paging:

- Press  **FIND HANDSET** on the telephone base when not in use. All idle handsets ring and display **** Paging ****.

To end paging:

- Press  **FIND HANDSET** at the telephone base.
- OR-**
- Press , , **OFF** or any of the dialing key on the handset.

-OR-

- Place the handset in the telephone base or charger.

- Press **MUTE** to turn off the ringer of a handset temporarily. Paging tone continues on the other handset.
- Do not press and hold  **FIND HANDSET** for more than four seconds. It may lead to handset deregistration. If the handset displays **To register HS...** and **...see manual**, refer to the **Frequently asked questions** section to register the handset back to the telephone base.



Redial list

Each handset stores the last 10 telephone numbers dialed. Entries are shown in reverse chronological order. When there are already 10 entries, the oldest entry is deleted to make room for the new entry.



Review a redial list entry

1. Press **REDIAL** when the handset is not in use.
2. Press **▼**, **▲** or **REDIAL** repeatedly until the desired entry displays.

Dial a redial list entry

1. Press **REDIAL** when the phone is not in use.
2. Press **▼**, **▲** or **REDIAL** repeatedly until the desired entry displays.
3. Press  or  to dial.

-OR-

1. Press  or  when the phone is not in use.
2. Press **REDIAL** and then press **▼**, **▲** or **REDIAL** repeatedly until the desired entry displays.
3. Press **SELECT** to dial.

Delete a redial list entry

1. Press **REDIAL** when the handset is not in use.
2. Press **▼**, **▲** or **REDIAL** repeatedly to browse to the desired entry.
3. Press **DELETE** to delete the displayed number. You hear a confirmation tone.

Multiple handset use

Intercom



Use the intercom feature for conversations between two handsets.

NOTES

- Your telephone base supports up to five handsets. You can buy additional expansion handsets (**CS5109**) for this telephone base.
- You can use four handsets on two pairs of intercom calls. For example, when four handsets are used on two pairs of intercom calls, use the fifth handset for an outside call.

1. Press **INT** on your handset when not in use.
 - If you have only one handset, your handset displays **INT needs 2 HS**.
 - If you have two handsets, your handset displays **Calling HS X**.
 - If you have three or more handsets, your handset displays **Intercom to**. Use the dialing keys to enter a destination handset. Your handset displays **Calling HS X**.

The destination handset rings and its screen displays **HS X is calling**.

2. To answer the intercom call, press  **TALK**, , **INT** or any dialing key on the destination handset. Both handsets now display **Intercom**.
3. To end the intercom call, press **OFF** or place the handset back in the telephone base or charger. Both handsets now display **Intercom ended**.

NOTES

- To cancel the intercom call before it is answered, press **OFF** or **INT**.
- Press **OFF** or **MUTE** on the destination handset to temporarily silence the intercom ringer.

- If the destination handset does not answer the intercom call within 100 seconds, is on a call or out of range, the originating handset displays **Unable to call** and returns to idle mode.
- If there is an incoming call while the originating handset displays **Calling HS X**, the intercom request will be stopped and the screen displays **Incoming call**.

Answer an incoming call during an intercom call

When you receive an outside call during an intercom call, there is an alert tone.

- To answer the outside call, press  **TALK**. The intercom call ends automatically.
- To end the intercom call without answering the outside call, press **OFF**. The telephone continues to ring.

Transfer a call

Use the intercom feature to transfer an outside call to another system handset.

1. During a call, press **INT**.
 - If you have two handsets, the outside call is put on hold and your handset displays **Calling HS X**.
 - If you have three or more handsets, your handset displays **Intercom to**. Use the dialing keys to enter a handset number. The outside call is put on hold and your handset displays **Calling HS X**.

The destination handset rings and its screen displays **HS X is calling**.

- To answer the intercom call on the destination handset, press , **INT** or any dialing key on the destination handset. The outside call is still on hold and both handsets now display **Intercom**. You can now have a private conversation with the destination handset.

NOTES

- To cancel the intercom call before it is answered, press , **OFF** or **INT**.
 - If the destination handset does not answer within 100 seconds, is in use, on a call or is out of range, the originating handset displays **Unable to call** and then reconnects to the outside call.
- For this intercom call, you have the following options:
 - You can let the destination handset join you on the outside call in a three-way conversation. Press and hold **INT** on the originating handset.
 - You can transfer the call. Press **OFF**, or place your handset back in the telephone base or charger. Your handset displays **Line in use**. The destination handset is then connected to the outside call.
 - You can press **INT** to switch between the outside call (**Outside call** displays) and the intercom call (**Intercom** displays).
 - The destination handset can end the intercom call by pressing **OFF**, or by placing the handset back in the telephone base or charger. The outside call continues with the original system handset.

Phonebook

The phonebook can store up to 50 entries, which are shared by all handsets. Each entry may consist of a telephone number up to 30 digits, and a name up to 15 characters.

Any additions, deletions or edits made on one handset will be reflected on other handsets.

If the telephone number in the phonebook exceeds 15 digits, a dash appears after the 14th digit and then the remaining digits are shown beginning with a dash, alternately.

Add a phonebook entry

- Enter the number when the phone is not in use. Press **MENU**, then go to Step 3.
-OR-
Press **MENU** when the phone is not in use, then press **SELECT** to choose **Phonebook**. Press **SELECT** again to choose **Add new entry**.
- When **Enter number** displays, use the dialing keys to enter the number.
-OR-
Copy a number from the redial list by pressing **REDIAL** and then press **▼**, **▲** or **REDIAL** repeatedly to select a number. Press **SELECT** to copy the number.
- Press **SELECT** to move on to enter the name. The handset displays **Enter name**.



- Use the dialing keys to enter the name. Additional key presses show other characters of that particular key. The first character of every word is capitalized.
- Press **SELECT** to save. You hear a confirmation tone.

While entering names and numbers, you can:

- Press **DELETE** to backspace and erase a digit or character.
- Press and hold **DELETE** to erase the entire entry.
- Press **▼** or **▲** to move the cursor to the left or right.
- Press and hold **PAUSE** to insert a dialing pause (for entering numbers only).
- Press **0** to add a space (for entering names only).

Review a phonebook entry

Entries are sorted alphabetically.

- Press  when the phone is not in use.
- Press **▼** or **▲** to browse through the phonebook, or use the dialing keys to start a name search.

-OR-

- Press **MENU** when the phone is not in use.
- Press **SELECT** to choose **Phonebook**.
- Press **▼** or **▲** to scroll to **Review** and then press **SELECT**.



- Press **▼** or **▲** to browse.



NOTE

- You hear two beeps when you reach the beginning or end of the phonebook.

Alphabetical search

- Follow the steps in **Review a phonebook entry** to enter the phonebook.
- Use the dialing keys to enter the letter associated with the name. For example, if you have entries for Jenny, Jessie, Kristen and Laura in your phonebook, press **5** (JKL) once to see Jenny (when **Jenny** displays, press **▼** to see Jessie), twice to see Kristen, or three times to see Laura. If there is no name entry matching your search, the next closest match in alphabetical order appears. If necessary, press **▼** or **▲** to browse.

Delete the phonebook entries

- Search for the desired entry in the phonebook (see **Review a phonebook entry** or **Alphabetical search**).
- When the desired entry appears, press **DELETE**. The handset displays **Delete entry?** and the number.
 
- Press **SELECT** to confirm. The handset displays **Deleting....** Then you hear a confirmation tone.
 

To delete all phonebook entries:



- Press **MENU** when the phone is not in use.
- Press **SELECT** to choose **Phonebook**.
- Press **▼** or **▲** to select **Delete all** then press **SELECT**.

4. The screen displays **Delete all?**. Press **SELECT** to confirm. The handset displays **Deleting...** and then you hear a confirmation tone.

Edit a phonebook entry

1. Search for the desired entry in the phonebook (see **Review a phonebook entry** or **Alphabetical search**).
2. When the desired entry appears, press **SELECT**. The handset displays **Enter number** and the stored number.
3. Use the dialing keys to edit the number, then press **SELECT**. The handset displays **Enter name** and then the stored name.
4. Use the dialing keys to edit the name. Additional key presses show other characters of that particular key. The first character of every word is capitalized.
5. Press **SELECT** to save. You hear a confirmation tone.

Dial a phonebook entry

1. Search for the desired entry in the phonebook (see **Review a phonebook entry** or **Alphabetical search**).
2. When the desired entry appears, press  or  to dial.

Caller ID

If you subscribe to caller ID service, information about each caller appears after the first or second ring. If you answer a call before the caller information appears on the screen, it will not be saved in the caller ID log.

The caller ID log stores up to 30 entries. Each entry has up to 24 digits for the phone number and 15 characters for the name.

If the telephone number has more than 15 digits, only the last 15 digits appear. If the name has more than 15 characters, only the first 15 characters are shown and saved in the caller ID log.

Entries appear in reverse chronological order. When the caller ID log is full, the oldest entry is deleted to make room for new incoming call information.

Caller ID log entries are shared by all system handsets. Any deletions made on one handset are reflected on all other handsets.

NOTE

- This product can provide information only if both you and the caller are in areas offering caller ID service and if both telephone service providers use compatible equipment. The time and date are sent by your telephone service provider along with the call information.

Review a caller ID log entry

1. Press **CID** when the phone is not in use.
2. Press **▼** or **▲** to browse through the caller ID log.

-OR-

1. Press **MENU** when the phone is not in use. Press **▼** or **▲** to select **Caller ID log**.

- Press **SELECT** twice and then press ▼ or ▲ to browse.

 **NOTE**

- You hear two beeps when you reach the beginning or end of the caller ID log.

Memory match

When the incoming telephone number matches the last seven digits of a telephone number in your phonebook, the screen displays the stored name of the phonebook entry.

For example, if Linda Jones calls, her name appears as **Linda** if this is how you entered it into your phonebook.

 **NOTE**

- The number shown in the caller ID log is in the format sent by the telephone service provider. It usually delivers 10-digit telephone numbers (area code plus phone number). If the last seven digits of the incoming telephone number does not match a number in your phonebook, the name appears as it is delivered by the telephone service provider.

Missed call indicator

When there are calls that have not been reviewed in the caller ID log, the handset displays **XX missed calls**.



Each time you review a caller ID log entry marked **NEW**, the number of missed calls decreases by one.



When you have reviewed all the missed calls, the missed call indicator no longer displays.

If you do not want to review the missed calls one by one, press and hold CANCEL on the idle handset to erase the missed call indicator. All the entries are then considered old.

View dialing options

Although the caller ID log entries received have 10 digits (the area code plus the seven-digit number), in some areas, you may dial only the seven digits, or a 1 plus the seven digits, or a 1 plus the area code plus the seven digits. You can change the number of digits that you dial from or store to the phonebook.

While reviewing the caller ID log, press **QUIET #** repeatedly to show different dialing options for local and long distance numbers before dialing or saving the telephone number in the phonebook.

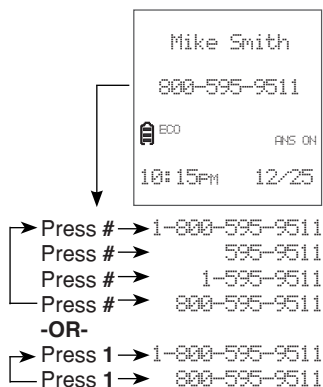

Press  **1** repeatedly if you need to add or remove 1 in front of the telephone number before dialing or saving it in the phonebook.



 **NOTE**

- If you have programmed the home area code, only the last seven digits of the incoming phone numbers from that area code will be displayed while reviewing the caller ID log. Press **QUIET #** repeatedly to display all possible dialing options.

Dial a caller ID log entry

When the number is shown in the correct format for dialing, press  or  to dial.

Save a caller ID log entry to the phonebook

1. When in the caller ID log, press ▼ or ▲ to browse.
2. When the desired caller ID log entry displays, press **SELECT** twice to choose **To Phonebook**. The handset displays **Enter number** and the stored number.
3. Use the dialing keys to modify the number, if necessary. Then press **SELECT**. The handset displays **Enter name** and then the stored name.
4. Use the dialing keys to modify the name, if necessary. Then press **SELECT** to save. You hear a confirmation tone.

While entering names and numbers, you can:

- Press **DELETE** to backspace and erase a digit or character.
- Press and hold **DELETE** to erase the entire entry.
- Press ▼ or ▲ to move the cursor to the left or right.
- Press and hold **PAUSE** to insert a dialing pause (for entering numbers only).
- Press **0** to add a space (for entering names only).

Delete the caller ID log entries

1. When in the caller ID log, press ▼ or ▲ to browse.
2. When the desired caller ID log entry displays, press **DELETE**. The handset displays **Deleting...** Then you hear a confirmation tone.

To delete all caller ID log entries:

1. Press **MENU** when the phone is not in use.
2. Press ▼ or ▲ to select **Caller ID log** and then press **SELECT**.
3. Press ▼ or ▲ to select **Delete all** then press **SELECT**.



4. The screen displays **Delete all?**. Press **SELECT** to confirm. The handset displays **Deleting...** and then you hear a confirmation tone.



Call block

If you have subscribed to caller ID service, you can set the telephone to block unknown calls and certain undesired calls. The call block list can store up to 20 entries.

When a call is blocked, the caller will hear a simulated busy tone for one ring cycle. The call recipient may pick up the call during the first ring when there is no caller ID information. Otherwise, the call is disconnected.

Block unknown calls

All incoming calls with unknown numbers will be blocked.

1. Press **MENU** when the phone is not in use.
2. Press **▼** or **▲** to select **Call block** and then press **SELECT**.
3. Press **▼** or **▲** to select **Calls w/o num** then press **SELECT**.
4. Press **▼** or **▲** to choose **Unblock** or **Block**, then press **SELECT**. You hear a confirmation tone.

Add a call block list entry

1. Press **MENU** when the phone is not in use.
2. Press **▼** or **▲** to select **Call block** and then press **SELECT**.
3. Press **SELECT** to choose **Block list**.
4. Press **▼** or **▲** to select **Add new entry** then press **SELECT**.
5. When **Enter number** displays, use the dialing keys to enter the number.
-OR-

Copy a number from the redial list by pressing **REDIAL** and then press **▼**, **▲** or **REDIAL** repeatedly to select a number. Press **SELECT** to copy the number.

6. Press **SELECT** to move on to enter the name. The handset displays **Enter name**.
7. Use the dialing keys to enter the name. Additional key presses show other characters of that particular key. The first character of every word is capitalized.
8. Press **SELECT** to save. You hear a confirmation tone.

While entering names and numbers, you can:

- Press **DELETE** to backspace and erase a digit or character.
- Press and hold **DELETE** to erase the entire entry.
- Press **▼** or **▲** to move the cursor to the left or right.
- Press and hold **PAUSE** to insert a dialing pause (for entering numbers only).
- Press **0** to add a space (for entering names only).

Review call block list

1. Press **MENU** when the phone is not in use.
2. Press **▼** or **▲** to select **Call block** and then press **SELECT**.
3. Press **SELECT** to choose **Block list**.
4. Press **SELECT** to choose **Review**.
5. Press **▼** or **▲** to browse through the call block list.

Edit a call block list entry

1. Search for the desired entry in the call block list (see **Review call block list**).
2. When the desired entry appears, press **SELECT**. The handset displays **Enter number** and the stored number.

3. Use the dialing keys to edit the number, then press **SELECT**. The handset displays **Enter name** and then the stored name.
4. Use the dialing keys to edit the name. Additional key presses show other characters of that particular key. The first character of every word is capitalized.
5. Press **SELECT** to save. You hear a confirmation tone.

Save a caller ID log entry to the call block list

1. When in the caller ID log, press ▼ or ▲ to browse.
2. When the desired caller ID log entry displays, press **SELECT** twice to choose **To Call block**. The handset displays **Enter number** and the stored number.
3. Use the dialing keys to modify the number, if necessary. Then press **SELECT**. The handset displays **Enter name** and then the stored name.
4. Use the dialing keys to modify the name, if necessary. Then press **SELECT** to save. You hear a confirmation tone.

Delete a call block list entry

1. Search for the desired entry in the call block list (see **Review call block list**).
2. When the desired call block list entry displays, press **DELETE** and you hear a confirmation tone.

Mute first ring

Your telephone rings once for blocked calls. You can choose to mute the first ring for all incoming calls, so that there will be no ring for blocked calls. By default, the first ring is set to **On**.

1. Press **MENU** when the handset is not in use.
2. Press **7464#** on the handset.
3. Press ▼ or ▲ to choose **First ring:On** to keep the first ring, or **First ring:Off** to mute the first ring.
4. Press **SELECT** to save. You hear a confirmation tone.

NOTE

- If you have muted the first ring, you will hear one ring less before the voicemail answers the incoming calls.

Sound settings

Key tone

You can turn the key tone on or off for each handset.

1. Press **MENU** when the handset is not in use.
2. Press **▼** or **▲** to choose **Settings** and then press **SELECT**.
3. Press **▼** or **▲** to choose **Key tone**, then press **SELECT**.
4. Press **▼** or **▲** to choose **On** or **Off**, then press **SELECT** to save. You hear a confirmation tone.

Ringer tone

You can choose from different ringer tones for each handset.

1. Press **MENU** when the handset is not in use.
2. Press **▼** or **▲** to choose **Ringers** and then press **SELECT**.
3. Press **▼** or **▲** to choose **Ringer tone**, then press **SELECT**.
4. The screen displays **Tone:** with the current setting displayed. Press **▼** or **▲** to sample each ringer tone.
5. Press **SELECT** to save. You hear a confirmation tone.

NOTE

- If you turn off the ringer volume, you will not hear ringer tone samples.

Ringer volume

You can adjust the handset ringer volume level, or turn the ringer off.

1. Press **MENU** when the handset is not in use.
2. Press **▼** or **▲** to choose **Ringers** and then press **SELECT** twice.
3. Press **▼** or **▲** to sample each ringer volume level.

4. Press **SELECT** to save. You hear a confirmation tone.

NOTES

- If the ringer volume is set to **Off**, the idle screen displays .
- When the ringer volume is set to **Off**, the handset still rings when you press **IFIND HANDSET** at the telephone base.

Temporary ringer silencing

When the telephone is ringing, you can temporarily silence the ringer without disconnecting the call. The next call rings normally at the preset volume.

- Press **CANCEL** or **MUTE**. The handset displays **Ringer muted** and .

Quiet mode

You can turn on the quiet mode for a period of time (1-12 hours). During this period, all tones (except paging tone) are muted.

To set the duration and turn on the quiet mode:

1. Press and hold **QUIET#** when the handset is not in use.
2. The handset displays **Quiet: __ hours**. Use the dialing keys (**0-9**) to enter the desired duration (1-12).
3. Press **SELECT** to save. You hear a confirmation tone.

The handset displays **Quiet mode on** and .

NOTE

- When you change the settings of the ringer tone or ringer volume, you can still hear the samples even if the quiet mode is on.

To turn off the quiet mode:

- Press and hold **QUIET#** when the handset is not in use. The handset displays **Quiet mode off** briefly and then returns to idle.

Retrieve voicemail from telephone service

Voicemail is a feature available from most telephone service providers. It may be included with your telephone service, or may be optional. Fees may apply.

Retrieve voicemail

When you received a voicemail, the handset displays  and **New voicemail**.

To retrieve, you typically dial an access number provided by your telephone service provider, and then enter a security code. Contact your telephone service provider for instructions on how to configure the voicemail settings and listen to messages.





NOTE

- After you have listened to all new voicemail messages, the indicators on the handset turn off automatically.

Set your voicemail number

You can save your access number on each handset for easy access to your voicemail.

After you saved the voicemail number, you can press and hold  **1** to retrieve voicemail.

1. Press and hold  **1** when the phone is not in use.
2. Use the dialing keys to enter the voicemail number (up to 30 digits).
3. Press **SELECT** to save. Then the handset dials the saved voicemail number.

-OR-

1. Press **MENU** when the handset is not in use.
2. Press **▼** or **▲** to choose **Settings** and then press **SELECT**.
3. Press **▼** or **▲** to choose **Voicemail #** and then press **SELECT**.
4. Use the dialing keys to enter the voicemail number (up to 30 digits).
5. Press **SELECT** to save. You hear a confirmation tone.

While entering numbers, you can:

- Press **DELETE** to backspace and erase a digit.
- Press and hold **DELETE** to erase the entire entry.
- Press **▼** or **▲** to move the cursor to the left or right.
- Press and hold **PAUSE** to insert a dialing pause.

Turn off the new voicemail indicators

If you have retrieved your voicemail while away from home, and the handset still displays the new voicemail indicators, use this feature to turn off the indicators.

NOTE

- This feature turns off the indicators only, it does not delete your voicemail messages.

1. Press **MENU** when the phone is not in use.
2. Press **▼** or **▲** to choose **Settings** and then press **SELECT**.
3. Press **▼** or **▲** to choose **Clr voicemail** and then press **SELECT**. You hear a confirmation tone.



Expand your telephone system

You can add new handsets (**CS5109**), cordless headsets (**IS6200**) or speakerphones (**MA3222** or AT&T **TL80133**) to your telephone system. All accessories are sold separately. Your telephone base supports a maximum of five devices.

For more details, refer to the user's manual that comes with your new device.

Screen messages

Calling HS X (for models with two or more handsets only)	You are calling another handset (for intercom calls).
Ended	You have just ended a call.
HS X is calling (for models with two or more handsets only)	Another handset is calling (for intercom calls).
Incoming call	There is an incoming call.
INT needs 2 HS	Two handsets are required for an intercom call.
Intercom	The handset is on an intercom call.
Intercom ended	The intercom call has just ended.
Intercom to (for models with three or more handsets only)	You have started the intercom process or started transferring a call, and need to enter the desired handset number.
Line in use	A system handset is in use, or another telephone on the same line is in use.
List empty	There are no phonebook entries, caller ID log entries or call block list entries.
Low battery	The battery needs to be recharged.
Microphone on	MUTE is turned off and the person on the other end can hear you.

Muted	You have turned off the handset microphone. The other party cannot hear you but you can hear the other party.
New voicemail	There are new voicemail message(s) from the telephone service provider.
No battery	No battery is installed. Follow the directions for battery installation on page 4 to install the battery before charging.
No line	There is no telephone line connected.
Not available	Another handset is already reviewing the phonebook, caller ID log or call block list.
Number repeated	The telephone number you enter is already stored in the phonebook.
Out of range or no fur at base	The handset cannot communicate with the telephone base. Check the telephone base power connection or move the handset closer to the telephone base.
Phone	The handset is on a call.
PRIVATE NAME	The caller is blocking the name information.
PRIVATE NUMBER	The caller is blocking the telephone number information.
PRIVATE CALLER	The caller is blocking the name and the telephone number information.

Put in charger	The battery is very low. Place the handset in the telephone base or charger for recharging.
Quiet mode off	The quiet mode is turned off.
Quiet mode on	The quiet mode is turned on.
Rec mem full	The phonebook is full.
Reg. failed	The handset registration is not successful.
Registering ...	The handset registration is in progress.
Ringer muted	The handset ringer is muted temporarily during an incoming call.
Ringer off	The handset ringer is turned off.
Speaker	The handset speakerphone is in use.
To register HS... ...see manual	Screen display on a non-registered handset.
Unable to call	Failed phone call (the other handset is in use).
UNKNOWN NAME	This caller's name is unavailable.
UNKNOWN NUMBER	This caller's number is unavailable.
UNKNOWN CALLER	No caller information is available about this caller.
XX missed calls	There are calls that have not been reviewed in the caller ID log.
** Paging **	The system handsets are being paged.

ECO mode

This power conserving technology reduces power consumption for optimal battery performance. The ECO mode activates automatically whenever the handset is synchronized with the telephone base.

General product care

Taking care of your telephone

Your cordless telephone contains sophisticated electronic parts, so it must be treated with care.

Avoid rough treatment

Place the handset down gently. Save the original packing materials to protect your telephone if you ever need to ship it.

Avoid water

Your telephone can be damaged if it gets wet. Do not use the handset outdoors in the rain, or handle it with wet hands. Do not install the telephone base near a sink, bathtub or shower.

Electrical storms

Electrical storms can sometimes cause power surges harmful to electronic equipment. For your own safety, take caution when using electrical appliances during storms.

Cleaning your telephone

Your telephone has a durable plastic casing that should retain its luster for many years. Clean it only with a dry non-abrasive cloth. Do not use dampened cloth or cleaning solvents of any kind.

Frequently asked questions

Below are the questions most frequently asked about the cordless telephone. If you cannot find the answer to your question, visit our website at www.vtechphones.com or call **1 (800) 595-9511** for customer service. In Canada, go to www.vtechcanada.com or call **1 (800) 267-7377**.

My telephone does not work at all.	Make sure the telephone base is installed properly, and battery is installed and charged correctly. For optimum daily performance, return the handset to the telephone base after use.
The display shows No line . I cannot hear the dial tone.	Disconnect the telephone line cord from your telephone and connect it to another telephone. If there is no dial tone on that other telephone either, then the telephone line cord may be defective. Try installing a new telephone line cord. If changing the telephone line cord does not help, the wall jack (or the wiring to this wall jack) may be defective. Contact your telephone service provider.
	You may be using a new cable or VoIP service, the existing telephone jacks in your home may no longer work. Contact your service provider for solutions.

I cannot dial out.	Make sure there is a dial tone before dialing. It is normal if the handset takes a second or two to synchronize with the telephone base before producing a dial tone. Wait an extra second before dialing.
	Eliminate any background noise. Mute the handset before dialing, or dial from another room in your home with less background noise.
The display shows To register HS... and ...see manual alternately. The handset does not work at all.	The handset is deregistered from the telephone base. Place the handset in the telephone base to register it back. The handset shows Registered when the registration process completes. This process takes about 60 seconds to complete.
The display shows Low battery .	Place the handset in the telephone base or charger for charging.
The battery does not charge in the handset or the handset battery does not accept charge.	Make sure the handset is placed in the telephone base or charger correctly. If the battery is completely depleted, charge the battery for at least 30 minutes before use. You may need to purchase a new battery.
The telephone does not ring when there is an incoming call.	Make sure the ringer volume is not set to off. The handset may be too far from the telephone base. Move it closer to the telephone base.
My handset beeps and is not performing normally.	Move the handset closer to the telephone base. It may be out of range.
I hear noise on the cordless handset and the keys do not work.	Make sure the telephone line cord is plugged in securely.

I hear other calls when using the telephone.	Disconnect the telephone base from the telephone wall jack. Plug in a different telephone. If you still hear other calls, the problem is probably in the wiring or telephone service. Contact your telephone service provider.
There is interference during a telephone conversation. My calls fade out when I am using the cordless handset.	The handset may be out of range. Move it closer to the telephone base.
	If you subscribe to high-speed Internet service (DSL - digital subscriber line) through your telephone line, you must install a DSL filter between the telephone line cord and the telephone wall jack. The filter prevents noise and caller ID problems caused by DSL interference. Contact your DSL service provider for more information about DSL filters.
	Appliances or other cordless telephones plugged into the same circuit as the telephone base can cause interference. Try moving the appliance or telephone base to another outlet.
The location of your telephone base can impact the performance of your cordless phone. For better reception, install the telephone base in a centralized location within your home or office, away from walls or other obstructions. In many environments, elevating the telephone base improves overall performance.	

The telephone does not receive caller ID or the telephone does not show caller ID during call waiting.	Caller ID is a subscription service. You must subscribe to this service from your telephone service provider for this feature to work on your telephone.
	Both your and the caller's telephone service providers must use equipment compatible with the caller ID service.
	The caller may not be calling from an area which supports caller ID.
	The caller ID information displays after the first or second ring.
The display shows Out of range or no pwr at base.	The handset may be out of range. Move it closer to the telephone base.
	Make sure the power cord is securely plugged into the telephone base. Use a working electrical outlet not controlled by a wall switch.
I subscribe to a nontraditional telephone service that uses my computer to establish connections, and my telephone doesn't work.	Make sure your computer is powered on, and your Internet is working properly.
	Make sure to plug your USB telephone adapter into a dedicated USB port on your computer. Do not plug into a multiple port USB hub (USB splitter) that is not powered.
	In a few rare instances, the USB port on your computer may not have enough power. In these instances, try using a USB hub with its own external power supply.
If you are using a firewall, it may prevent access to your nontraditional telephone service. Contact your service provider for more information.	

<p>I accidentally set my LCD language to Spanish or French, and I don't know how to change it back to English.</p>	<p>While the handset is not in use, press MENU and then enter *364# to change the handset LCD language back to English.</p>
--	---

The RBRC® seal

The RBRC® seal on the nickel-metal hydride battery indicates that VTech Communications, Inc. is voluntarily participating in an industry program to collect and recycle these batteries at the end of their useful lives, when taken out of service within the United States and Canada.

The RBRC® program provides a convenient alternative to placing used nickel-metal hydride batteries into the trash or municipal waste, which may be illegal in your area.

VTech's participation in RBRC® makes it easy for you to drop off the spent battery at local retailers participating in the RBRC® program or at authorized VTech product service centers. Please call **1 (800) 8 BATTERY®** for information on Ni-MH battery recycling and disposal bans/restrictions in your area. VTech's involvement in this program is part of its commitment to protecting our environment and conserving natural resources.

RBRC® and 1 (800) 8 BATTERY® are registered trademarks of Rechargeable Battery Recycling Corporation.



FCC, ACTA and IC regulations

FCC Part 15

NOTE: This equipment has been tested and found to comply with the requirements for a Class B digital device under Part 15 of the Federal Communications Commission (FCC) rules. These requirements are intended to provide reasonable protection against harmful interference in a residential installation. This equipment generates, uses and can radiate radio frequency energy and, if not installed and used in accordance with the instructions, may cause harmful interference to radio communications. However, there is no guarantee that interference will not occur in a particular installation. If this equipment does cause harmful interference to radio or television reception, which can be determined by turning the equipment off and on, the user is encouraged to try to correct the interference by one or more of the following measures:

- Reorient or relocate the receiving antenna.
- Increase the separation between the equipment and receiver.
- Connect the equipment into an outlet on a circuit different from that to which the receiver is connected.
- Consult the dealer or an experienced radio/TV technician for help.

WARNING: Changes or modifications to this equipment not expressly approved by the party responsible for compliance could void the user's authority to operate the equipment.

This device complies with Part 15 of the FCC rules. Operation is subject to the

following two conditions: (1) this device may not cause harmful interference, and (2) this device must accept any interference received, including interference that may cause undesired operation. Privacy of communications may not be ensured when using this telephone.

To ensure safety of users, the FCC has established criteria for the amount of radio frequency energy that can be safely absorbed by a user or bystander according to the intended usage of the product. This product has been tested and found to comply with the FCC criteria. The handset may be safely held against the ear of the user. The telephone base shall be installed and used such that parts of the user's body other than the hands are maintained at a distance of approximately 20 cm (8 inches) or more.

This Class B digital apparatus complies with Canadian requirement: CAN ICES-3 (B)/NMB-3(B).

FCC Part 68 and ACTA

This equipment complies with Part 68 of the FCC rules and with technical requirements adopted by the Administrative Council for Terminal Attachments (ACTA). The label on the back or bottom of this equipment contains, among other things, a product identifier in the format US:AAAEQ##TXXXX. This identifier must be provided to your telephone service provider upon request.

The plug and jack used to connect this equipment to premises wiring and the telephone network must comply with applicable Part 68 rules and technical requirements adopted by ACTA. A compliant telephone cord and modular

plug is provided with this product. It is designed to be connected to a compatible modular jack that is also compliant. An RJ11 jack should normally be used for connecting to a single line and an RJ14 jack for two lines. See the installation instructions in the user's manual.

The Ringer Equivalence Number (REN) is used to determine how many devices you may connect to your telephone line and still have them ring when you are called. The REN for this product is encoded as the 6th and 7th characters following the US: in the product identifier (e.g., if ## is 03, the REN is 0.3). In most, but not all areas, the sum of all RENs should be five (5.0) or less. For more information, please contact your telephone service provider.

This equipment must not be used with Party Lines. If you have specially wired alarm dialing equipment connected to your telephone line, ensure the connection of this equipment does not disable your alarm equipment. If you have questions about what will disable alarm equipment, consult your telephone service provider or a qualified installer.

If this equipment is malfunctioning, it must be unplugged from the modular jack until the problem has been corrected. Repairs to this telephone equipment can only be made by the manufacturer or its authorized agents. For repair procedures, follow the instructions outlined under the Limited warranty.

If this equipment is causing harm to the telephone network, the telephone service provider may temporarily discontinue your telephone service. The telephone service provider is required to notify you before interrupting service. If advance

notice is not practical, you will be notified as soon as possible. You will be given the opportunity to correct the problem and the telephone service provider is required to inform you of your right to file a complaint with the FCC. Your telephone service provider may make changes in its facilities, equipment, operation, or procedures that could affect the proper functioning of this product. The telephone service provider is required to notify you if such changes are planned.

If this product is equipped with a corded or cordless handset, it is hearing aid compatible.

If this product has memory dialing locations, you may choose to store emergency telephone numbers (e.g., police, fire, medical) in these locations. If you do store or test emergency numbers, please:

Remain on the line and briefly explain the reason for the call before hanging up. Perform such activities in off-peak hours, such as early morning or late evening.

Industry Canada

This device complies with Industry Canada licence-exempt RSS standard(s).

Operation is subject to the following two conditions: (1) this device may not cause harmful interference, and (2) this device must accept any interference, including interference that may cause undesired operation.

Privacy of communications may not be ensured when using this telephone.

The term "IC:" before the certification/registration number only signifies that the Industry Canada technical specifications were met.

The Ringer Equivalence Number (REN) for this terminal equipment is 1.0. The REN is an indication of the maximum number of devices allowed to be connected to a telephone interface. The termination on an interface may consist of any combination of devices subject only to the requirement that the sum of the RENs of all the devices does not exceed five.

This product meets the applicable Industry Canada technical specifications.

California Energy Commission battery charging testing instructions

This telephone is set up to comply with the energy-conserving standards right out of the box. These instructions are intended for California Energy Commission (CEC) compliance testing only. When the CEC battery charging testing mode is activated, all telephone functions, except battery charging, will be disabled.

To activate the CEC battery charging testing mode:

1. Unplug the telephone base power adapter from the power outlet. Make sure all handsets are plugged with charged batteries before proceeding.
2. While you press and hold **Ⓜ FIND HANDSET**, plug the telephone base power adapter back to the power outlet.
3. After about 20 seconds, when the **IN USE** light starts flashing, release **Ⓜ FIND HANDSET** and then press it again within 2 seconds.

NOTES

- When the phone successfully enters the CEC battery charging testing mode, the **IN USE** light turns off and all handsets display **To register HS...** and **...see manual** alternatively.
- When the phone fails to enter this mode, repeat Step 1 through Step 3 above.

To deactivate the CEC battery charging testing mode:

1. Unplug the telephone base power adapter from the power outlet, then plug it back in. Then the telephone base is powered up as normal.
2. Place the handset in the telephone base to register it back. The handset displays **Registering....**

NOTE

- The handset shows **Registered** when the registration process completes. The registration process takes about 60 seconds to complete.

For C-UL compliance only

Mesures de sécurité importantes

Afin de réduire les risques d'incendie, de blessures corporelles ou d'électrocution, suivez toujours ces mesures préventives de base lorsque vous utilisez votre téléphone :

1. Lisez et comprenez bien toutes les instructions.
2. Observez toutes les instructions et mises en garde inscrites sur l'appareil.
3. Débranchez ce téléphone de la prise murale avant de le nettoyer. N'utilisez pas de nettoyeurs liquides ni en aérosol. N'utilisez qu'un chiffon doux et légèrement humecté.
4. N'utilisez pas ce produit près de l'eau, tel que près d'un bain, d'un lavabo, d'un évier de cuisine, d'un bac de lavage ou d'une piscine, ou dans un sous-sol humide ou sous la douche.
5. Ne déposez pas ce téléphone sur un chariot, support ou table chancelants. L'appareil pourrait tomber et être sérieusement endommagé.
6. Évitez d'installer le système téléphonique dans les endroits soumis à une température extrême, à la lumière directe du soleil ou à proximité immédiate d'autres appareils électriques ou électroniques. Protégez votre téléphone contre les sources d'humidité, la poussière, les vapeurs et les liquides corrosifs.
7. Le boîtier de l'appareil est doté de fentes et d'ouvertures d'aération situées à l'arrière ou en dessous. Afin d'empêcher la surchauffe, ces ouvertures ne doivent pas être obstruées en plaçant l'appareil sur un lit, divan, tapis ou autre surface similaires. Ne placez pas cet appareil à proximité d'un élément de chauffage ni d'une plinthe électrique. De plus, ne l'installez pas dans une unité murale ou un cabinet fermé qui ne possède pas d'aération adéquate.
8. Ne faites fonctionner cet appareil qu'avec le type d'alimentation indiqué sur les étiquettes de l'appareil. Si vous ne connaissez pas le voltage de votre maison, consultez votre marchand ou votre fournisseur d'électricité.
9. Ne déposez rien sur le cordon d'alimentation. Installez cet appareil dans un endroit sécuritaire, là où personne ne pourra trébucher sur la ligne d'alimentation ni le cordon téléphonique modulaire.
10. N'insérez jamais d'objets à travers les fentes et ouvertures de cet appareil, car ils pourraient toucher à des points de tension dangereux ou court-circuiter des pièces, ce qui constituerait un risque d'incendie ou d'électrocution. N'échappez pas de liquides dans l'appareil.
11. Afin de réduire les risques d'électrocution, ne démontez pas l'appareil, mais apportez-le plutôt à un centre de service qualifié s'il doit être réparé. En enlevant le couvercle, vous vous exposez à des tensions dangereuses ou autres dangers similaires. Un remontage inadéquat peut être à l'origine d'une électrocution lors d'une utilisation ultérieure de l'appareil. Débranchez l'appareil avant de procéder au nettoyage. Utilisez un chiffon humide et doux.
12. Ne surchargez pas les prises de courant et les rallonges.

13. Débranchez cet appareil de la prise de courant et communiquez avec le département de service à la clientèle de VTech dans les cas suivants :

- Lorsque le cordon d'alimentation est endommagé ou écorché.
- Si du liquide a été échappé dans l'appareil.
- Si l'appareil a été exposé à une source d'humidité telle que la pluie ou l'eau.
- Si le produit ne fonctionne pas normalement en respectant les instructions de fonctionnement. Réglez uniquement les commandes indiquées dans les instructions de fonctionnement. Les réglages incorrects des autres commandes pourraient provoquer un dommage qui pourrait exiger un travail exhaustif de la part d'un technicien autorisé afin de rétablir le fonctionnement normal de l'appareil.
- Si le produit a été échappé et que le socle et/ou le combiné a été endommagé.
- Si le produit affiche une nette diminution de sa performance.

14. Évitez d'utiliser un téléphone (autre qu'un sans fil) pendant un orage. Les éclairs peuvent être à l'origine d'une électrocution.

15. N'utilisez pas le téléphone pour rapporter une fuite de gaz à proximité de la fuite. En certaines circonstances, une flammèche pourrait être provoquée lorsque l'adaptateur est branché à une prise de courant, ou lorsque le combiné est déposé sur le socle. Ceci est un événement commun associé à la fermeture d'un circuit électrique. L'utilisateur ne devrait pas

brancher le téléphone à une prise de courant, et ne devrait pas déposer le combiné chargé sur le socle, si le téléphone se trouve à proximité d'un endroit comportant des concentrations de gaz inflammables, à moins que la ventilation soit adéquate. Une flammèche dans un tel endroit pourrait provoquer un incendie ou une explosion. De tels environnements peuvent comprendre: des endroits où l'on utilise de l'oxygène médical sans ventilation adéquate; des gaz industriels (dissolvants de nettoyage, des vapeurs d'essence, etc.); une fuite de gaz naturel, etc.

16. Ne placez que le combiné de votre téléphone près de votre oreille lorsqu'en mode de conversation.

17. Ces adaptateurs ont été conçus pour être orientés en position verticale ou montés au sol. Les broches ne sont pas conçues pour maintenir l'adaptateur en place si celui-ci est branché dans une prise au plafond ou sous une table/ armoire.

CONSERVEZ CES INSTRUCTIONS

Pile

- **MISE EN GARDE** : N'utilisez que la pile incluse.
- Ne jetez pas la pile au feu. Vérifiez les instructions spécifiques de mise aux rebus auprès des autorités locales.
- N'ouvrez pas et ne mutilez pas la pile. L'électrolyte qui s'en échapperait est corrosif et pourrait causer des brûlures ou des blessures aux yeux ou à la peau. L'électrolyte est toxique si avalé.
- Soyez prudents lorsque vous manipulez les piles afin d'éviter les courts-circuits provoqués par des matériaux conducteurs.

- Rechargez la pile incluse avec cet appareil, selon les instructions et limites spécifiées dans ce guide d'utilisation.

Stimulateurs cardiaques implantés dans l'organisme

Les simulateurs cardiaques (s'applique uniquement aux téléphones numériques sans fil) :

L'organisme 'Wireless Technology Research, LLC (WTR)', une firme de recherche indépendante, a mené une évaluation pluridisciplinaire des interférences entre les téléphones sans fil portatifs et les stimulateurs cardiaques implantés dans l'organisme. Appuyée par l'Administration des aliments et drogues (FDA) des États-Unis, la firme WTR recommande aux médecins :

Avis aux détenteurs de stimulateurs cardiaques

- Ils doivent tenir le téléphone sans fil à une distance d'au moins six pouces du stimulateur cardiaque.
- Ils ne doivent PAS placer le téléphone sans fil directement sur le stimulateur cardiaque, tel que dans une poche de chemise, lorsque celui-ci est en marche.
- Ils doivent utiliser le téléphone sans fil en l'appuyant sur l'oreille qui se trouve dans la direction opposée au stimulateur cardiaque.

L'étude effectuée par l'organisme WRS n'a pas identifié de risque pour les détenteurs de simulateurs cardiaques causés par les gens qui utilisent un téléphone sans fil à proximité de ceux-ci.

À propos des téléphones sans fil

- **Confidentialité** : Les mêmes caractéristiques qui constituent des avantages pour les téléphones

sans fil affichent également des restrictions. Les appels téléphoniques sont transmis entre le combiné sans fil et le socle par le biais d'ondes radio ; il y a donc la possibilité que vos conversations téléphoniques sans fil soient interceptées par des équipements de réception radio se trouvant dans la portée du combiné sans fil. Pour cette raison, vous ne devez pas percevoir les communications téléphoniques sans fil comme étant aussi confidentielles que celles des téléphones à cordons.

- **Alimentation électrique** : Le socle de ce téléphone sans fil doit être branché à une prise électrique fonctionnelle. La prise électrique ne doit pas être contrôlée par un interrupteur mural. Les appels ne pourront pas être effectués du combiné sans fil si le socle est débranché ou mis hors tension ou si le courant est coupé.
- **Possibilité d'interférences aux téléviseurs** : Certains téléphones sans fil fonctionnent sur des fréquences pouvant causer des interférences aux téléviseurs et aux magnétoscopes. Pour réduire ou prévenir de telles interférences, ne placez pas le socle du téléphone sans fil près ou sur un téléviseur ou magnétoscope. S'il y a présence de parasites, il est conseillé d'éloigner le téléphone sans fil du téléviseur ou du magnétoscope afin de réduire possiblement les interférences.
- **Piles rechargeables** : Manipulez les piles avec soin afin de ne pas les court-circuiter avec des bagues, bracelets ou clés. Les piles ou le conducteur peut surchauffer et causer des blessures. Respectez la polarité adéquate entre la pile et le chargeur.

- **Les bloc-piles rechargeables à l'hydrure métallique de nickel :** Jetez ces blocs-piles de manière écologique et sécuritaire. Ne les incinérez pas et ne les percez pas. Tel que les autres piles de ce type, elles pourraient dégager une matière toxique qui peut causer des blessures corporelles si elles sont brûlées ou percées.

Limited warranty

What does this limited warranty cover?

The manufacturer of this VTech Product warrants to the holder of a valid proof of purchase (“Consumer” or “you”) that the Product and all accessories provided in the sales package (“Product”) are free from defects in material and workmanship, pursuant to the following terms and conditions, when installed and used normally and in accordance with the Product operating instructions. This limited warranty extends only to the Consumer for Products purchased and used in the United States of America and Canada.

What will VTech do if the Product is not free from defects in materials and workmanship during the limited warranty period (“Materially Defective Product”)?

During the limited warranty period, VTech’s authorized service representative will repair or replace at VTech’s option, without charge, a Materially Defective Product. If we repair the Product, we may use new or refurbished replacement parts. If we choose to replace the Product, we may replace it with a new or refurbished Product of the same or similar design. We will retain defective parts, modules, or equipment. Repair or replacement of the Product, at VTech’s option, is your exclusive remedy. VTech will return the repaired or replacement Products to you in working condition. You should expect the repair or replacement to take approximately 30 days.

How long is the limited warranty period?

The limited warranty period for the Product extends for ONE (1) YEAR from the date of purchase. If VTech repairs or replaces a Materially Defective Product under the terms of this limited warranty, this limited warranty also applies to the repaired or replacement Product for a period of either (a) 90 days from the date the repaired or replacement Product is shipped to you or (b) the time remaining on the original one-year warranty; whichever is longer.

What is not covered by this limited warranty?

This limited warranty does not cover:

1. Product that has been subjected to misuse, accident, shipping or other physical damage, improper installation, abnormal operation or handling, neglect, inundation, fire, water or other liquid intrusion;
2. Product that has been damaged due to repair, alteration or modification by anyone other than an authorized service representative of VTech;
3. Product to the extent that the problem experienced is caused by signal conditions, network reliability, or cable or antenna systems;
4. Product to the extent that the problem is caused by use with non-VTech accessories;
5. Product whose warranty/quality stickers, product serial number plates or electronic serial numbers have been removed, altered or rendered illegible;
6. Product purchased, used, serviced, or shipped for repair from outside the United States of America or Canada, or used for commercial or institutional purposes (including

but not limited to Products used for rental purposes);

7. Product returned without a valid proof of purchase (see item 2 below); or
8. Charges for installation or set up, adjustment of customer controls, and installation or repair of systems outside the unit.

How do you get warranty service?

To obtain warranty service in the USA, please visit our website at www.vtechphones.com or call 1 (800) 595-9511. In Canada, go to www.vtechcanada.com or call 1 (800) 267-7377.

NOTE: Before calling for service, please review the user's manual - a check of the Product's controls and features may save you a service call.

Except as provided by applicable law, you assume the risk of loss or damage during transit and transportation and are responsible for delivery or handling charges incurred in the transport of the Product(s) to the service location. VTech will return repaired or replaced Product under this limited warranty. Transportation, delivery or handling charges are prepaid. VTech assumes no risk for damage or loss of the Product in transit. If the Product failure is not covered by this limited warranty, or proof of purchase does not meet the terms of this limited warranty, VTech will notify you and will request that you authorize the cost of repair prior to any further repair activity. You must pay for the cost of repair and return shipping costs for the repair of Products that are not covered by this limited warranty.

What must you return with the Product to get warranty service?

1. Return the entire original package and contents including the Product to the VTech service location along with a description of the malfunction or difficulty; and
2. Include a “valid proof of purchase” (sales receipt) identifying the Product purchased (Product model) and the date of purchase or receipt; and
3. Provide your name, complete and correct mailing address, and telephone number.

Other limitations

This warranty is the complete and exclusive agreement between you and VTech. It supersedes all other written or oral communications related to this Product. VTech provides no other warranties for this Product. The warranty exclusively describes all of VTech’s responsibilities regarding the Product. There are no other express warranties. No one is authorized to make modifications to this limited warranty and you should not rely on any such modification.

State/Provincial Law Rights: This warranty gives you specific legal rights, and you may also have other rights, which vary from state to state or province to province.

Limitations: Implied warranties, including those of fitness for a particular purpose and merchantability (an unwritten warranty that the Product is fit for ordinary use) are limited to one year from the date of purchase. Some states/provinces do not allow limitations on how long an implied warranty lasts, so the above limitation may not apply to you. In no event shall VTech be liable for any indirect, special, incidental,

consequential, or similar damages (including, but not limited to lost profits or revenue, inability to use the Product or other associated equipment, the cost of substitute equipment, and claims by third parties) resulting from the use of this Product. Some states/provinces do not allow the exclusion or limitation of incidental or consequential damages, so the above limitation or exclusion may not apply to you.

Please retain your original sales receipt as proof of purchase.

Technical specifications

Frequency control	Crystal controlled PLL synthesizer
Transmit frequency	Handset: 1921.536-1928.448 MHz Telephone base: 1921.536-1928.448 MHz
Channels	5
Nominal effective range	Maximum power allowed by FCC and IC. Actual operating range may vary according to environmental conditions at the time of use.
Power requirements	Handset: 2.4V Ni-MH battery Telephone base: 6V DC @ 400mA Charger: 6V DC @ 400mA
Memory	Phonebook: 50 memory locations; up to 30 digits and 15 characters Caller ID log: 30 memory locations; up to 24 digits and 15 characters Call block: 20 entries



Designed to fit your home.
And your life.

VTech Communications, Inc.
A member of THE VTECH GROUP OF COMPANIES.
VTech is a registered trademark of VTech Holdings Limited.
Specifications are subject to change without notice.
© 2018 VTech Communications, Inc.
All rights reserved. 05/18. CS5119-X_WEBCIB_V5.0
Document order number: 91-008940-030-100

