



Analogue Contemporary Series User's Guide

Model:

Analogue corded trimstyle hotel telephone - A2310

Important safety instructions

When using your telephone equipment, basic safety precautions should always be followed to reduce the risk of fire, electric shock and injury, including the following:

1. This product should be installed by a qualified technician.
2. This product should only be connected to the host equipment and never directly to the network such as Public Switch Telephone Network (PSTN) or Plain Old Telephone Services (POTS).
3. Read and understand all instructions.
4. Follow all warnings and instructions marked on the product.
5. Unplug this product from the wall outlet before cleaning. Do not use liquid or aerosol cleaners. Use a damp cloth for cleaning.
6. Do not use this product near water such as near a bath tub, wash bowl, kitchen sink, laundry tub or swimming pool, or in a wet basement or shower.
7. Do not place this product on an unstable table, shelf, stand or other unstable surfaces.
8. Slots and openings in the back or bottom of the telephone base and handset are provided for ventilation. To protect them from overheating, these openings must not be blocked by placing the product on a soft surface such as a bed, sofa or rug. This product should never be placed near or over a radiator or heat register. This product should not be placed in any area where proper ventilation is not provided.
9. This product should be operated only from the type of power source indicated on the marking label. If you are not sure of the type of power supply on the premises, consult your dealer or local power company.
10. Do not allow anything to rest on the power cord. Do not install this product where the cord may be walked on.
11. Never push objects of any kind into this product through the slots in the telephone base or handset because they may touch dangerous voltage points or create a short circuit. Never spill liquid of any kind on the product.
12. To reduce the risk of electric shock, do not disassemble this product, but take it to an authorized service facility. Opening or removing parts of the telephone base or handset other than specified access doors may expose you to dangerous voltages or other risks. Incorrect reassembling can cause electric shock when the product is subsequently used.
13. Do not overload wall outlets and extension cords.
14. Unplug this product from the wall outlet and refer servicing to an authorized service facility under the following conditions:
 - When the power supply cord or plug is damaged or frayed.
 - If liquid has been spilled onto the product.
 - If the product has been exposed to rain or water.
 - If the product does not operate normally by following the operating instructions. Adjust only those controls that are covered by the operation instructions. Improper adjustment of other controls may result in damage and often requires extensive work by an authorized technician to restore the product to normal operation.
 - If the product has been dropped and the telephone base and/or handset has been damaged.
 - If the product exhibits a distinct change in performance.
15. Avoid using a telephone (other than cordless) during an electrical storm. There is a remote risk of electric shock from lightning.
16. Do not use the telephone to report a gas leak in the vicinity of the leak. Under certain circumstances, a spark may be created when the adapter is plugged into the power outlet, or when the handset is replaced in its cradle. This is a common event associated with the closing of any electrical circuit. The user should not plug the phone into a power outlet, and should not put a charged handset into the cradle, if the phone is located in an environment containing concentrations of flammable or flame-supporting gases, unless there is adequate ventilation. A spark in such an environment could create a fire or explosion. Such environments might include: medical use of oxygen without adequate ventilation; industrial gases (cleaning solvents; gasoline vapors; etc.); a leak of natural gas; etc.
17. Only put the handset of your telephone next to your ear when it is in normal talk mode.
18. The power adapters are intended to be correctly oriented in a vertical or floor mount position. The prongs are not designed to hold the plug in place if it is plugged into a ceiling, under-the-table or cabinet outlet.
19. For pluggable equipment, the socket-outlet (power adapter) shall be installed near the equipment and shall be easily accessible.
20. Use only the power cord and batteries indicated in this manual. Do not dispose of batteries in a fire. They may explode. Check with local codes for possible special disposal instructions.
21. In wall mounting position, make sure to mount the telephone base on the wall by aligning the eyelets with the mounting studs of the wall plate. Then slide the telephone base down on both mounting studs until it locks into place. Refer to the full instructions in **Installation** in the user's manual.
22. **CAUTION:** Keep small metallic objects such as pins and staples away from the handset receiver.

SAVE THESE INSTRUCTIONS

For cETL compliance only

Mesures de sécurité importantes

Afin de réduire les risques d'incendie, de blessures corporelles ou d'électrocution, suivez toujours ces mesures préventives de base lorsque vous utilisez votre téléphone:

1. Cet appareil doit être installé par un technicien qualifié.
2. Cet appareil doit être branché à un équipement hôte et jamais branché à un réseau, tel qu'un réseau PSTN public ou un réseau téléphonique standard (POTS).
3. Lisez et comprenez bien toutes les instructions.
4. Observez toutes les instructions et mises en garde inscrites sur l'appareil.
5. Débranchez ce téléphone de la prise murale avant de le nettoyer. N'utilisez pas de nettoyeurs liquides ni en aérosol. N'utilisez qu'un chiffon doux et légèrement humecté.
6. N'utilisez pas ce produit près de l'eau, tel que près d'un bain, d'un lavabo, d'un évier de cuisine, d'un bac de lavage ou d'une piscine, ou dans un sous-sol humide ou sous la douche.
7. Ne déposez pas ce téléphone sur un chariot, support ou table chancelants. L'appareil pourrait tomber et être sérieusement endommagé.
8. Le boîtier de l'appareil est doté de fentes et d'ouvertures d'aération situées à l'arrière ou en dessous. Afin d'empêcher la surchauffe, ces ouvertures ne doivent pas être obstruées en plaçant l'appareil sur un lit, divan, tapis ou autre surface similaires. Ne placez pas cet appareil à proximité d'un élément de chauffage ni d'une plinthe électrique. De plus, ne l'installez pas dans une unité murale ou un cabinet fermé qui ne possède pas d'aération adéquate.
9. Ne faites fonctionner cet appareil qu'avec le type d'alimentation indiqué sur les étiquettes de l'appareil. Si vous ne connaissez pas le voltage de votre maison, consultez votre marchand ou votre fournisseur d'électricité.
10. Ne déposez rien sur le cordon d'alimentation. Installez cet appareil dans un endroit sécuritaire, là où personne ne pourra trébucher sur la ligne d'alimentation ni le cordon téléphonique modulaire.
11. N'insérez jamais d'objets à travers les fentes et ouvertures de cet appareil, car ils pourraient toucher à des points de tension dangereux ou court-circuiter des pièces, ce qui constituerait un risque d'incendie ou d'électrocution. N'échappez pas de liquides dans l'appareil.
12. Afin de réduire les risques d'électrocution, ne démontez pas l'appareil, mais apportez-le plutôt à un centre de service qualifié s'il doit être réparé. En enlevant le couvercle, vous vous exposez à des tensions dangereuses ou autres dangers similaires. Un remontage inadéquat peut être à l'origine d'une électrocution lors d'une utilisation ultérieure de l'appareil.
13. Ne surchargez pas les prises de courant ni les rallonges électriques, car ceci peut constituer un risque d'incendie ou d'électrocution.
14. Unplug this product from the wall outlet and refer servicing to an authorized service facility under the following conditions:
 - Lorsque le cordon d'alimentation est endommagé ou écorché.
 - Si du liquide a été échappé dans l'appareil.
 - Si l'appareil a été exposé à une source d'humidité telle que la pluie ou l'eau.
 - Si l'appareil ne fonctionne pas normalement en suivant les directives du guide. N'ajustez que les commandes couvertes dans le guide d'utilisation, car un mauvais réglage de celles-ci peut être à l'origine de dommages, ce qui nécessiterait des réparations considérables pour remettre l'appareil à son état de fonctionnement normal.
 - Si l'appareil a été échappé ou son boîtier, endommagé.
 - Si le produit affiche une nette diminution de sa performance.
15. Évitez d'utiliser un téléphone (autre qu'un sans fil) pendant un orage. Les éclairs peuvent être à l'origine d'une électrocution.
16. N'utilisez pas le téléphone pour rapporter une fuite de gaz à proximité de celle-ci. Sous certaines circonstances, une intencelle pourrait survenir lorsque l'adaptateur est branché à une prise de courant, ou lorsque le combiné est déposé sur le combiné. Ceci est un événement commun associé avec la fermeture d'un circuit électrique. L'utilisateur ne devrait pas brancher le téléphone dans une prise de courant, et ne devrait pas déposer le combiné chargé sur le socle, si le téléphone se trouve dans un environnement où la concentration de gaz inflammables, sans ventilation adéquate. Une étincelle dans ces endroits pourrait provoquer un incendie ou une explosion. Ces environnements pourraient être l'utilisation médicale de l'oxygène sans ventilation adéquate; le gaz industriel (dissolvants, vapeurs d'essence, etc.); une fuite de gaz naturel, etc.
17. Placez uniquement le combiné de votre appareil près de votre oreille lorsqu'il est en mode de conversation normal.
18. Les adaptateurs sont conçus pour être orientés en position verticale ou en position horizontale sur le plancher. Les fiches ne sont pas conçues pour maintenir la prise en place si celle-ci est branchée au plafond, sous la table ou les armoires.
19. Pour les PRODUITS À BRANCHER À UNE PRISE DE COURANT, la prise de courant doit être installée près du produit, afin d'assurer une accessibilité sécuritaire à la prise de courant.
20. N'utilisez que cordon d'alimentation et les piles indiquées dans ce guide d'utilisation. Ne jetez pas les piles au feu. Celles-ci risqueraient d'exploser. Vérifiez avec les règlements locaux afin de vous assurer de respecter les instructions spéciales de mise aux rebus de telles pièces.
21. En position de montage mural, assurez-vous de monter le socle du téléphone sur le mur en alignant les oeilletons avec les goujons de fixation de la plaque murale. Ensuite, faites glisser le socle vers le bas sur les deux goujons de fixation jusqu'à ce qu'il se verrouille en place. Reportez-vous aux instructions complètes dans la section **Installation** dans ce guide d'utilisation.
22. **MISE EN GARDE** : Éloignez les petits objets métalliques tels que les broches de l'écouteur du combiné.





CONSERVEZ CES INSTRUCTIONS

Table of contents

Parts checklist	5
Telephone layout	6
Installation	7
Set up	9
Operation	10
Appendix	11
Troubleshooting	11
VTech Hospitality limited warranty program	12
Maintenance	13
Important note	14
Environmental notes	14
Product disposal instructions	14
Technical information	14
European Directives	14
Declaration of Conformance	14
Technical specifications	15

Parts checklist

Items contained in the telephone package:

Model name	Model number	Parts included
Analogue corded trimstyle	A2310	 Telephone base with faceplate and overlay  Corded handset  Mounting bracket  Telephone line cord

Telephone layout



Installation

Telephone base installation

The telephone can be adapted to desktop use or mount on a standard telephone wall plate.

Installation option - desktop position

1. Turn the telephone base over with the bottom side facing up. Connect the telephone line cord to the telephone base and route along the wire duct.

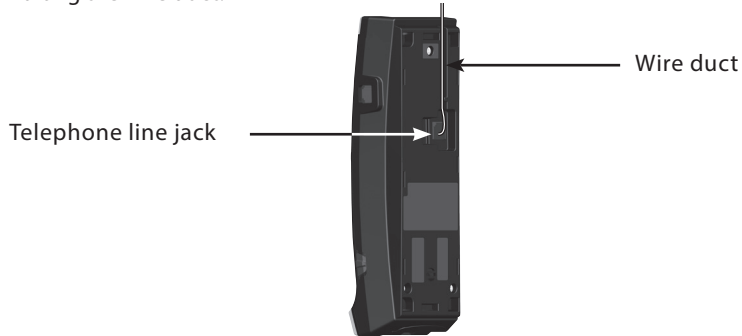

2. Position the mounting bracket as shown. Insert the two small tabs of the mounting bracket into the lower slots on the telephone base. Then press the large tab on the mounting bracket and firmly push it into the upper groove on the telephone base.

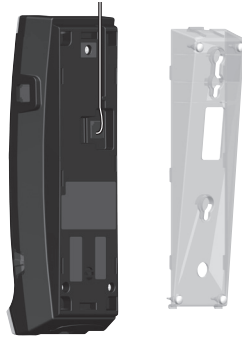

3. Install the telephone base as shown below. Then connect the coiled handset cord to the telephone base.

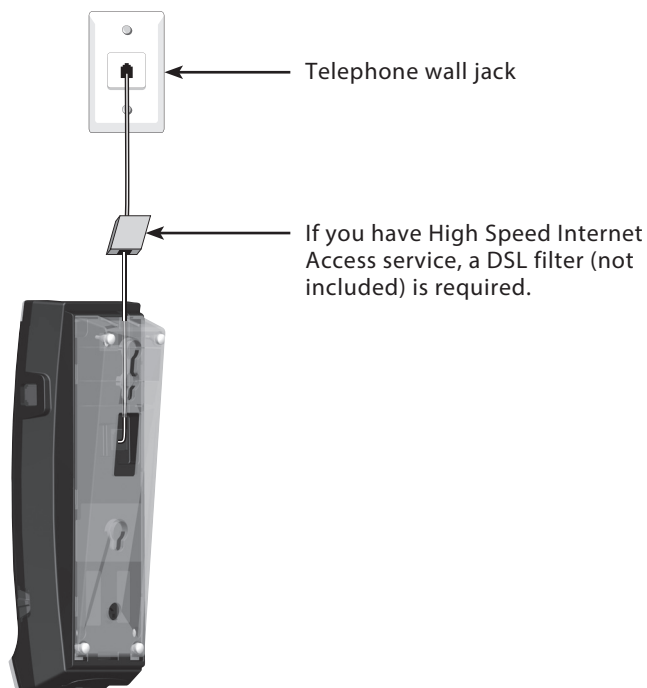

Installation

Installation option - converting from desktop to wall mount position

To mount the telephone base on the wall:

1. Set aside the handset. On the telephone base cradle, place a coin in the slit of the wall mount clip and rotate a half turn (180 degrees). It locks into place with the protruding edge pointing towards the upper edge of the charging base. This protruding edge holds the cordless handset when the phone is mounted on the wall.

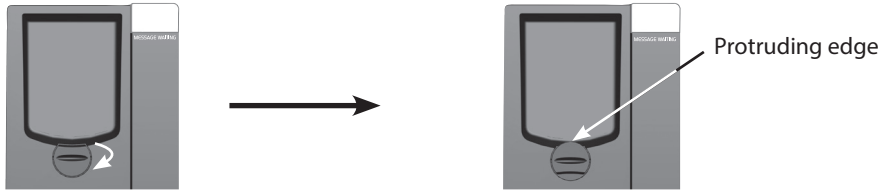

2. Unplug the telephone line cord from the telephone wall jack. Then press the large tab on the mounting bracket to remove it from the upper groove on the telephone base.

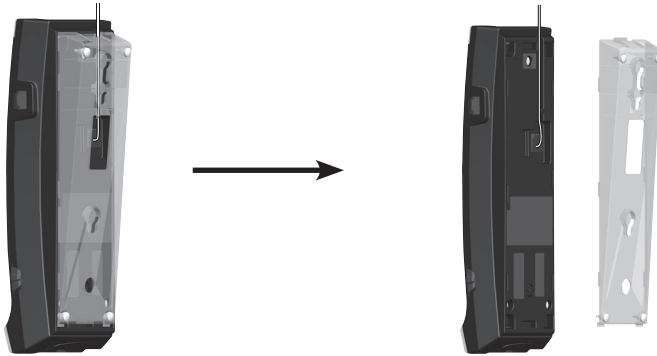

3. Turn the mounting bracket upside down. Remove the telephone line cord from the wire duct and then route it through the rectangular hole on the mounting bracket. Insert the small tabs on the mounting bracket into the upper slots on the telephone base. Then press the large tab on the mounting bracket and firmly push it into the lower groove on the telephone base.

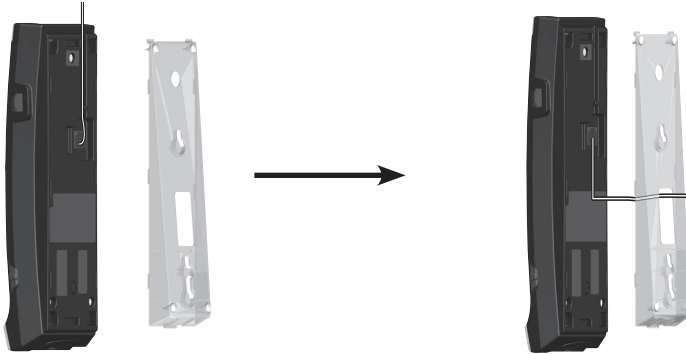

4. Mount the telephone base on the wall by aligning the eyelets with the mounting studs of the wall plate. Then slide the telephone base down on both mounting studs until it locks into place. Place the handset on the telephone base cradle.

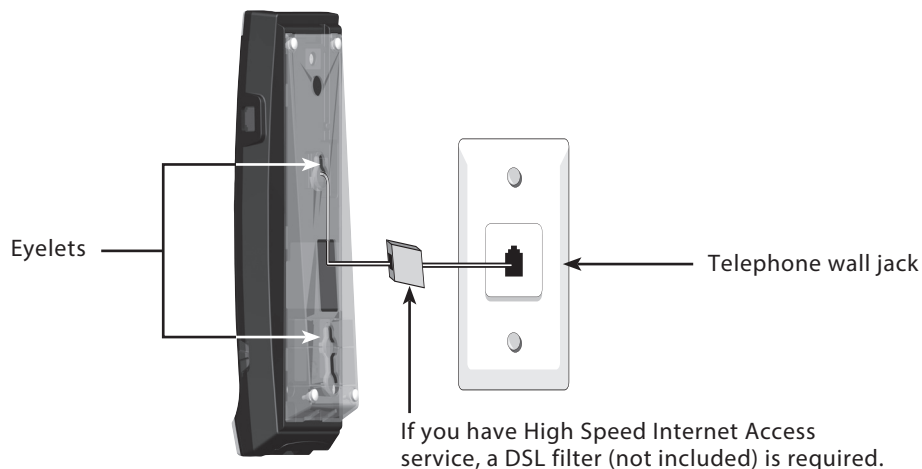

Set up

Default settings are indicated by asterisks (*).

Setting	Options	Adjustable by
Handset earpiece volume	1, 2, 3*, 4, 5	User and administrator
Ringer volume	Low, Medium*, High	User and administrator
Ringer tone	Tone 1*, Tone 2, Tone 3	Administrator only
Voicemail voltage detection	Disable voicemail voltage detection, Periodic low voltage pulse detection method, Steady high voltage and periodic high voltage pulse detection method	Administrator only

Ringer tone

There are 3 ringer tone options.

To change the ringer tone:

1. Turn the telephone base over with the bottom side facing up.
 - Remove the mounting bracket. To remove the mounting bracket, firmly press down the tab on it and pull out to detach it from the telephone base.



Mounting bracket

2. Slide the ringer tone switch to select the desired detented position using a narrow object such as a standard screwdriver.

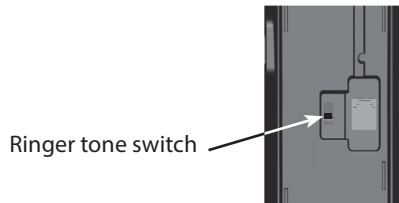

3. Install the mounting bracket accordingly.

Voicemail voltage detection

There are 3 options to set the voicemail voltage detection on the telephone base.

To disable the voicemail voltage detection:

1. Remove the sticker at the bottom of the telephone base.
2. Use a narrow object to unplug all the jumpers from the telephone base.
3. Place the sticker back in place.

To set the voicemail voltage detection by the periodic low voltage pulse detection method:

1. Remove the sticker at the bottom of the telephone base.
2. Use a narrow object to unplug all the jumpers from the telephone base. Then plug the jumpers into ①, ② and ③.
3. Place the sticker back in place.

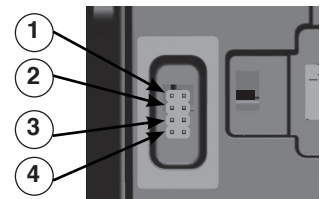

To set the voicemail voltage detection by the steady high voltage and periodic high voltage pulse detection method:

1. Remove the sticker at the bottom of the telephone base.
2. Use a narrow object to unplug all the jumpers from the telephone base. Then plug the jumpers into ①, ② and ④.
3. Place the sticker back in place.

Operation

Receive a call

When there is an incoming call, the telephone rings and the **MESSAGE WAITING** LED flashes.

To answer a call:

Lift the corded handset from the telephone base.

Place a call

Lift the corded handset from the telephone base. Listen for a dial tone and then dial the desired number.

End a call

Place the corded handset in the telephone base.

Share a call

During a call, parallel telephones (telephones on the same line) can join the call. If the parallel telephone is a 2-line model, this telephone can only share call on one of the lines.

To join a call:

During a call, lift the corded handset to join.

Volume

Listening volume and ringer volume can be adjusted.

To adjust the listening volume:

During a call, press **-VOLUME+** to adjust the listening volume. The next call returns to the default listening volume.

To adjust the ringer volume:

At any time, slide the **RINGER VOL** switch on the right side of the telephone base to adjust the ringer volume.

Call waiting

1. When you hear a call waiting tone during a call, press **FLASH** on the handset to put your current call on hold and take the new incoming call.
2. Press **FLASH** or the switch hook once rapidly at any time to switch back and forth between calls.

Mute

To mute the microphone:

1. During a call, press **MUTE** on the handset. The **MUTE** LED flashes when the mute function is turned on. You can hear the party on the other end but they cannot hear you.
2. Press any key to resume the conversation. The **MUTE** LED turns off.

Data port

You can connect your modem or fax machine to the telephone line through the **FAX/DATA** port.

Appendix

Troubleshooting

If you have difficulty with the telephones, please try the suggestions below. For customer service, visit our website at www.vtechhotelp hones.com or contact your local distributor.

For corded telephones:

The telephone does not work at all.

- Make sure the telephone line is plugged into the **TEL** port of the telephone base.
- Make sure the telephone line cord is plugged firmly into the telephone wall jack.
- Disconnect the telephone base from the telephone wall jack and plug in a working telephone. If the other telephone does not work, the problem is probably in the wiring or telephone service. Contact your telephone service provider (charges may apply).

There is no dial tone.

- Try all the above suggestions.
- The telephone line cord may be defective. Install a new telephone line cord.
- Disconnect the telephone base from the telephone wall jack and connect a different telephone. If there is no dial tone on this telephone either, the problem is in your wiring or telephone service. Contact your telephone service provider (charges may apply).

I cannot dial out.

- Try all the above suggestions.
- Make sure there is a dial tone before dialing.
- Eliminate any background noise. Mute the telephone before dialing, if applicable, or dial from another room in your unit with less background noise.
- If other telephones in your hotel are having the same problem, the problem is in the wiring or telephone service. Contact your telephone service provider (charges may apply).

The telephone does not ring when there is an incoming call.

- Make sure the telephone line cord is plugged in properly.
- If other telephones in your hotel are having the same problem, the problem is in the wiring or telephone service. Contact your telephone service provider (charges may apply).
- Test a working telephone at the telephone wall jack. If another telephone has the same problem, the problem is in the telephone wall jack. Contact your telephone service provider (charges may apply).
- The telephone line cord may be defective. Install a new telephone line cord.

There is interference during a telephone conversation.

- If there is High Speed Internet Access (HSIA) available at the premises through a telephone line, you may need to install a DSL filter (DSL - digital subscriber line) between the telephone line cord and the telephone wall jack. The filter prevents noise and caller ID problems caused by DSL interference. Contact your DSL service provider for more information about DSL filters.
- If your telephone is plugged in with a modem or a surge protector, plug the telephone (or modem/surge protector) into a different location. If this doesn't solve the problem, relocate your telephone or modem farther apart from each other, or use a different surge protector.
- Disconnect the telephone base from the telephone wall jack. Plug in a different telephone. If calls are still not clear, the problem is probably in the wiring or local telephone service. Contact your telephone service provider (charges may apply).
- If other telephones in your hotel are having the same problem, the problem is in the wiring or telephone service. Contact your telephone service provider (charges may apply).

I hear other calls when using the telephone.

- Disconnect the telephone base from the telephone wall jack. Plug in a different telephone. If you still hear other calls, the problem is probably in the wiring or telephone service. Contact your telephone service provider (charges may apply).

Appendix

VTech Hospitality limited warranty program

VTech Telecommunications Limited, the manufacturer of VTech Hospitality Product ("Product"), warrants to the holder of a valid proof of purchase ("end user" or "you") that the Product and all accessories provided by VTech in the Product's package are free from defects in material and workmanship, pursuant to the following terms and conditions, when installed and used normally and in accordance with the Product's operating instructions. The limited warranty extends to the end user of this Product and applies only if such Product is purchased through a local distributor /dealer.

During the limited warranty period, VTech's authorised service representative will repair or replace, at VTech's option, without charge, a Product that is not free from defects in materials and workmanship. If VTech's authorised service representative repairs the Product, new or refurbished replacement parts may be used. If the Product is replaced, it may be replaced with a new or refurbished Product of the same or similar design. Repair or replacement of Product, at VTech's option, is the exclusive remedy.

The limited warranty period for the Product begins on the date that the end user takes possession of the Product. This limited warranty also applies to repaired or replacement Products for a period of either: (a) 90 days from the date the repaired or replacement Product is shipped to you; or (b) the time remaining on the original limited warranty as described above; whichever is longer.

This limited warranty does not cover:

1. Product or parts that have been subjected to misuse, accident, shipping or other physical damage, improper installation, abnormal operation or handling, neglect, inundation, fire, water or other liquid intrusion; or
2. Product that has been damaged due to repair, alteration or modification by anyone other than an authorised service representative of VTech; or
3. Product to the extent that the problem experienced is caused by signal conditions, network reliability or cable or antenna systems; or
4. Product to the extent that the problem is caused by use with non-VTech accessories; or
5. Product whose warranty/quality stickers, product serial number plates or electronic serial numbers have been removed, altered or rendered illegible; or
6. Product purchased, used, serviced, or shipped for repair from outside the local dealer / distributor, or used for non-approved commercial or institutional purposes (including but not limited to Products used for rental purposes); or
7. Product returned without valid proof of purchase; or
8. Charges or costs incurred by the end user, and risk of loss or damage, in removing and shipping the Product, or for installation or set up, adjustment of customer controls, and installation or repair of systems outside the unit.
9. Line cords or coil cords, plastic overlays, connectors, power adapters and batteries, if the Product is returned without them. VTech will charge the end user at then-current prices for each of the missing items.
10. NiCd or NiMH handset batteries, or power adapters, which, under all circumstances, are covered by a one (1) year warranty only.

Except as provided by applicable law, you assume the risk of loss or damage during transit and transportation and are responsible for delivery or handling charges incurred in the transport of Product(s) to the service location. VTech's authorised service representative will return repaired or replaced product under this limited warranty to you, transportation, delivery and handling charges prepaid. VTech assumes no risk for damage or loss of the Product in transit.

If the Product failure is not covered by this limited warranty, or proof of purchase does not meet the terms of this limited warranty, VTech will notify you and will request that you authorise the cost of repair and return shipping costs for the repair of Products that not covered by this limited warranty. You must pay for the cost of repair and return shipping costs for the repair of Products that are not covered by this limited warranty.

Other limitations

This warranty is the complete and exclusive agreement between you and VTech. It supersedes all other written or oral communications related to this Product. VTech provides no other warranties for this Product, whether express or implied, oral or written, or statutory. The warranty exclusively describes all of VTech's responsibilities regarding the Product. No one is authorised to make modifications to this warranty and you should not rely on any such modification.

VTech's liability to end user hereunder shall not exceed the purchase price of the Product. In no event shall VTech be liable for any indirect, special, incidental, consequential, or similar damages (including, but not limited to lost profits or revenue, inability to use the product, or other associated equipment, the cost of substitute equipment, and claims by third parties) resulting from the use of this Product. Some local dealers / distributors do not allow the exclusion or limitation of incidental or consequential damages, so the above limitation or exclusion may not apply to you.

This warranty gives you specific legal rights, and you also have other rights which vary from local dealer / distributor to local dealer / distributor.

Appendix

Maintenance

Taking care of the telephone

The telephone contains sophisticated electronic parts, so it must be treated with care.

Avoid rough treatment

Place the handset down gently. Save the original packing materials to protect the telephone if you ever need to ship it.

Avoid water

The telephone can be damaged if it gets wet. Do not use the handset outdoors in the rain, or handle it with wet hands. Do not install the telephone base near a sink, bathtub or shower.

Electrical storms

Electrical storms can sometimes cause power surges harmful to electronic equipment. For your own safety, take caution when using electrical appliances during storms.

Cleaning the telephone

The telephone has a durable plastic casing that should retain its luster for many years. Clean it only with a soft cloth slightly dampened with water or mild soap. Do not use excess water or cleaning solvents of any kind.

Remember that electrical appliances can cause serious injury if used when you are wet or standing in water.

If the telephone base should fall into water, DO NOT RETRIEVE IT UNTIL YOU UNPLUG THE POWER CORD AND/OR TELEPHONE LINE CORD FROM THE WALL. Then remove the telephone by the unplugged cords.

Appendix

Important note

This equipment is not designed for making emergency telephone call when the power fails. Alternative arrangements should be made for access to emergency services.

Environmental notes

- Do not expose to direct sunlight.
- Do not place your product on carpets or other surfaces which generate fibres, or place in locations where proper ventilation is not provided.
- Do not submerge any part of your product in water and do not use it in damp or humid conditions, such as bathrooms.
- Do not expose your product to fire, explosive or other hazardous conditions.
- Avoid using a telephone (other than cordless) during an electrical storm. There is a remote risk of electric shock from lightning.

Product disposal instructions

The symbol shown here and on the product means that the product is classed as Electrical or Electronic Equipment and should not be disposed with other household or commercial waste at the end of its working life.



The Waste of Electrical and Electronic Equipment (WEEE) Directive (2012/19/EU) has been put in place to recycle products using best available recovery and recycling techniques to minimize the impact on the environment, treat any hazardous substances and avoid the increasing landfill.

Product disposal instructions for residential users

When you have no further use for it, please remove any batteries and dispose of them and the product as per your local authority's recycling processes. For more information please contact your local authority or the retailer where the product was purchased.

Product disposal instructions for business users

Business users should contact their suppliers and check the terms and conditions of the purchase contract and ensure that this product is not mixed with other commercial waste for disposal.

Technical information

Specific Absorption Rate (SAR)

This device meets applicable international safety requirements for exposure to radio waves.

The max. limit according to WHO is 2W/kg (per 10g tissue).

This telephone measures 0.03 W/kg (per 10g tissue).

European Directives

These equipments are compliant with directives 1999/5/EC (R&TTE), 2014/35/EU (LVD), 2014/30/EU (EMC) and 2011/65/EU (ROHS).

Declaration of Conformance

Hereby, VTech declares that cordless equipment are in compliance with the essential requirements of directive 1999/5/EC (R&TTE)
The Declaration of Conformity may be obtained from: www.vtechhotelphones.com.



Appendix

Technical specifications

Analogue corded trimstyle - A2310

Power requirement	Line powered 24V or 48V
Message waiting signal	Steady/periodic high voltage pulse and periodic low voltage pulse
Size	Telephone base: 8.47 x 2.87 x 2.17 in (215 x 73 x 55 mm) Corded handset: 8.39 x 1.85 x 1.65 in (213 x 47 x 42 mm)
Manufacturer	VTech Telecommunications Limited Address: 23/F Tai Ping Industrial Centre, Block 1, 57 Ting Kok Road, Tai Po, Hong Kong

vtech[®]

VTECH TELECOMMUNICATIONS LTD.
A member of THE VTECH GROUP OF COMPANIES.
VTech is the registered trademark of VTech Holdings Limited.
Copyright © 2023 for VTECH TELECOMMUNICATIONS LTD
A2310_UG_V1_CEC_EU-UK_2023.05.29
All rights reserved. 05/23. Printed in China.