

ANALOGUE CONTEMPORARY SERIES

PETITE PHONE

A2211-SPK

Analogue Contemporary Petite 1-line Corded Hotel Telephone

**vtech**<sup>®</sup>

User's Guide

# IMPORTANT SAFETY INSTRUCTIONS

When using your telephone equipment, basic safety precautions should always be followed to reduce the risk of fire, electric shock and injury, including the following:

1. This product should be installed by a qualified technician.
2. This product should only be connected to the host equipment and never directly to the network such as Public Switch Telephone Network (PSTN) or Plain Old Telephone Services (POTS).
3. Read and understand all instructions.
4. Follow all warnings and instructions marked on the product.
5. Unplug this product from the wall outlet before cleaning. Do not use liquid or aerosol cleaners. Use a damp cloth for cleaning.
6. Do not use this product near water such as near a bath tub, wash bowl, kitchen sink, laundry tub or swimming pool, or in a wet basement or shower.
7. Do not place this product on an unstable table, shelf, stand or other unstable surfaces.
8. Slots and openings in the back or bottom of the telephone base and handset are provided for ventilation. To protect them from overheating, these openings must not be blocked by placing the product on a soft surface such as a bed, sofa or rug. This product should never be placed near or over a radiator or heat register. This product should not be placed in any area where proper ventilation is not provided.
9. This product should be operated only from the type of power source indicated on the marking label. If you are not sure of the type of power supply on the premises, consult your dealer or local power company.
10. Do not allow anything to rest on the power cord. Do not install this product where the cord may be walked on.
11. Never push objects of any kind into this product through the slots in the telephone base or handset because they may touch dangerous voltage points or create a short circuit. Never spill liquid of any kind on the product.
12. To reduce the risk of electric shock, do not disassemble this product, but take it to an authorized service facility. Opening or removing parts of the telephone base or handset other than specified access doors may expose you to dangerous voltages or other risks. Incorrect reassembling can cause electric shock when the product is subsequently used.
13. Do not overload wall outlets and extension cords.
14. Unplug this product from the wall outlet and refer servicing to an authorized service facility under the following conditions:
  - When the power supply cord or plug is damaged or frayed.
  - If liquid has been spilled onto the product.
  - If the product has been exposed to rain or water.
  - If the product does not operate normally by following the operating instructions.

Adjust only those controls that are covered by the operation instructions. Improper adjustment of other controls may result in damage and often requires extensive work by an authorized technician to restore the product to normal operation.

- If the product has been dropped and the telephone base and/or handset has been damaged.
- If the product exhibits a distinct change in performance.

15. Avoid using a telephone (other than cordless) during an electrical storm. There is a remote risk of electric shock from lightning.

16. Do not use the telephone to report a gas leak in the vicinity of the leak. Under certain circumstances, a spark may be created when the adapter is plugged into the power outlet, or when the handset is replaced in its cradle. This is a common event associated with the closing of any electrical circuit. The user should not plug the phone into a power outlet, and should not put a charged handset into the cradle, if the phone is located in an environment containing concentrations of flammable or flame-supporting gases, unless there is adequate ventilation. A spark in such an environment could create a fire or explosion. Such environments might include: medical use of oxygen without adequate ventilation; industrial gases (cleaning solvents; gasoline vapors; etc.); a leak of natural gas; etc.

17. Only put the handset of your telephone next to your ear when it is in normal talk mode.

18. The power adapters are intended to be correctly oriented in a vertical or floor mount position. The prongs are not

designed to hold the plug in place if it is plugged into a ceiling, under-the-table or cabinet outlet.

19. Use only the power cord and batteries indicated in this manual. Do not dispose of batteries in a fire. They may explode. Check with local codes for possible special disposal instructions.

20. In wall mounting position, make sure to mount the telephone base on the wall by aligning the eyelets with the mounting studs of the wall plate. Then slide the telephone base down on both mounting studs until it locks into place. Refer to the full instructions in Installation in the user's manual.





## SAVE THESE INSTRUCTIONS

# TABLE OF CONTENTS

<b>Important safety instructions</b>	<b>2</b>
<b>Parts check list</b>	<b>5</b>
<b>Telephone layout</b>	<b>6</b>
<b>Installation</b>	<b>7</b>
<b>Set up</b>	<b>9</b>
<b>Operation</b>	<b>11</b>
<b>Appendix</b>	<b>12</b>
Troubleshooting	12
VTech Hospitality Limited Warranty Program	15
Maintenance	17
Disclaimer and Limitation of Liability	17
European Directives	17
Declaration of Conformity	17
Disposal of batteries and product	18
<b>Technical specification</b>	<b>19</b>

# Parts check list

Items contained in the respective telephone package:

MODEL NAME	MODEL NUMBER	PARTS INCLUDED			
		TELEPHONE BASE WITH FACEPLATE AND OVERLAY	CORDED HANDSET	MOUNTING BRACKET	TELEPHONE LINE CORD
Analogue Contemporary Petite 1-line Corded Hotel Telephone	A2211-SPK				

# Telephone layout

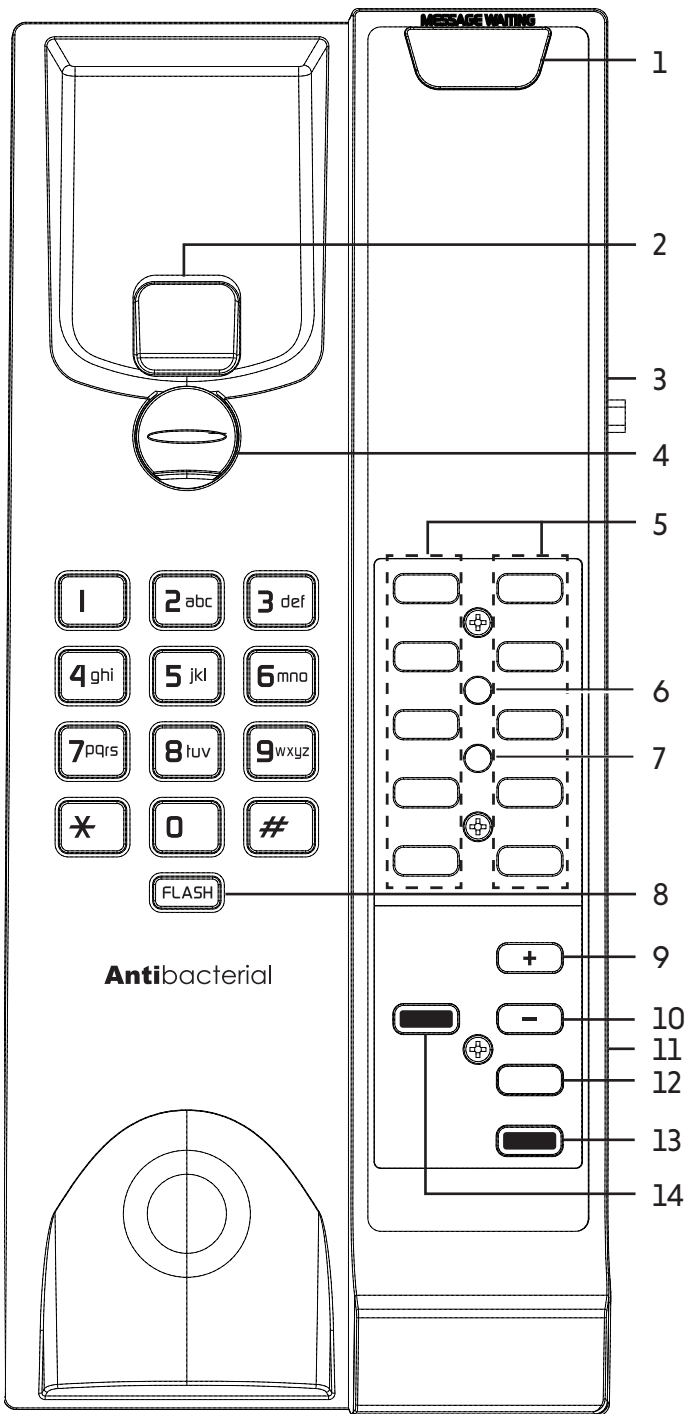

1	<b>MESSAGE WAITING LED</b>
2	Switch hook
3	<b>FAX/ DATA</b> port
4	Wall mount clip
5	Speed Dial keys
6	<b>PROGRAM</b> (recessed key)
7	<b>PAUSE</b> (recessed key)
8	<b>FLASH</b> Key
9	<b>+ / VOLUME</b>
10	<b>- / VOLUME</b>
11	<b>RINGER VOL</b>
12	<b>HOLD</b> Key
13	<b>SPEAKER</b> Key
14	<b>MUTE</b> Key

# Installation

## TELEPHONE BASE INSTALLATION

The telephone can be adapted to desktop use or mounted on a standard telephone wall plate.

### INSTALLATION OPTION - DESKTOP POSITION

1. Turn the telephone base over with the bottom side facing up. Connect the telephone line cord to the telephone base and route along the wire duct.

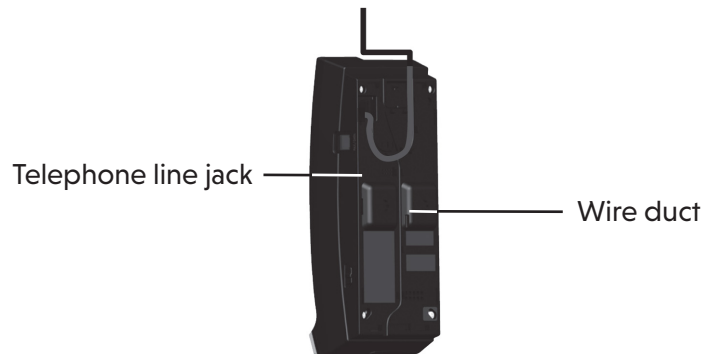

2. Position the mounting bracket as shown. Insert the two small tabs of the mounting bracket into the lower slots on the telephone base. Then press the large tab on the mounting bracket and firmly push it into the upper groove on the telephone base.

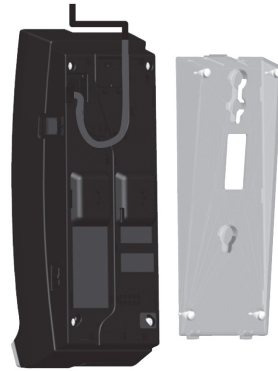

3. Install the telephone base as shown below. Then connect the coiled handset cord to the telephone base.

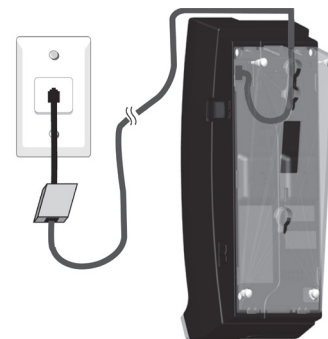

## INSTALLATION OPTION - CONVERTING FROM DESKTOP TO WALL MOUNT POSITION

### TO MOUNT THE TELEPHONE BASE ON THE WALL

1. Set aside the handset. On the telephone base cradle, place a coin in the slit of the wall mount clip and rotate a half turn (180 degrees).

- It locks into place with the protruding edge pointing towards the upper edge of the telephone base. This protruding edge holds the corded handset when the phone is mounted on the wall.

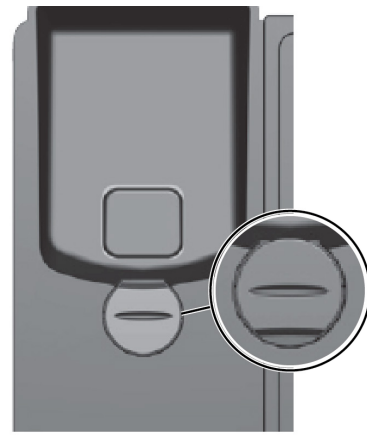

2. Unplug the telephone line cord from the telephone wall jack. Then press the large tab on the upper groove on the telephone base.

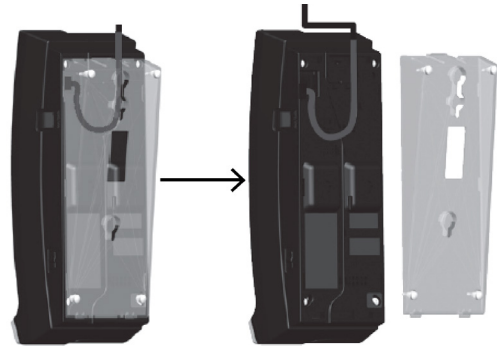

3. Turn the mounting bracket upside down. Remove the telephone line cord from the wire duct and then route it through the groove on the bottom part the mounting bracket. Insert the small tabs on the mounting bracket into the upper slots on the telephone base. Then press the large tab on the mounting bracket and firmly push it into the lower groove on the telephone base.

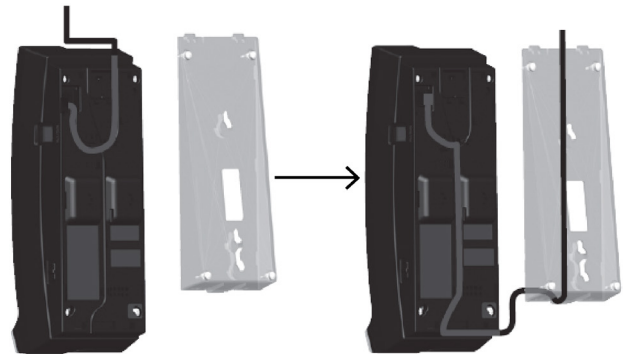

4. Mount the telephone base on the wall by aligning the eyelets with the mounting studs of the wall plate. Then slide the telephone base down on both mounting studs until it locks into place. Place the handset on the telephone base cradle.

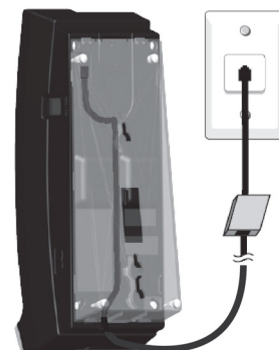



# Set up

Default settings are indicated by asterisks (\*).

SETTING	OPTIONS	ADJUSTABLE BY
Speakerphone volume	1, 2, 3, 4, 5*, 6, 7, 8	User and administrator
Ringer volume	Low, Medium*, High	User and administrator
Ringer tone	Tone 1*, Tone 2, Tone 3	Adminstrator only
Flash	1 (100ms), 2 (300ms), 3* (600ms)	Adminstrator only
Voicemail voltage detection	Disable voicemail voltage detection, Periodic low voltage pulse detection method, Steady high voltage and periodic high voltage pulse detection method	Adminstrator only

## RINGER TONE

There are 3 ringer tone options.

### TO CHANGE THE RINGER TONE

1. Turn the telephone base over with the bottom side facing up. Remove the mounting bracket if it is in desktop position. To remove the mounting bracket, firmly push both tabs downward and pull up until they release from the grooves.
2. Slide the ringer tone switch to select the desired detented position using a narrow object such as a standard screwdriver.
3. Install the mounting bracket accordingly.

## FLASH

There are 3 flash duration options that can be programmed.

### TO CHANGE THE FLASH DURATION

1. Remove the faceplate and overlay if they are on the telephone base. Press **SPEAKER** on the telephone base or lift the handset. Then press the recessed **PROGRAM** key. The **MUTE** key flashes when in administrator mode.
2. Press **FLASH** and you hear 3 beeps. Then press a dialing key, **1** (100ms), **2** (300ms) or **3** (600ms), to select the desired flash duration. Press the recessed **PROGRAM** key again. You hear 3 rising beeps as confirmation.

## VOICEMAIL VOLTAGE DETECTION

There are 3 options to set the voicemail voltage detection on the telephone base.

### TO DISABLE THE VOICEMAIL VOLTAGE DETECTION

1. Use a narrow object to unplug all the jumpers from the telephone base.
2. Place the sticker back in place.

### TO SET THE VOICEMAIL VOLTAGE DETECTION BY THE PERIODIC LOW VOLTAGE PULSE DETECTION METHOD

1. Use a narrow object to unplug all the jumpers from the telephone base. Then plug the jumpers into ①, ② and ③.
2. Place the sticker back in place.

### TO SET THE VOICEMAIL VOLTAGE DETECTION BY THE STEADY HIGH VOLTAGE AND PERIODIC HIGH VOLTAGE PULSE DETECTION METHOD

1. Use a narrow object to unplug all the jumpers from the telephone base. Then plug the jumpers into ①, ② and ④.
2. Place the sticker back in place.

## SPEED DIAL KEYS

10 customer service (speed dial) keys that can be set: M1, M2, M3, M4, M5, M6, M7, M8, M9 and M10. Program these keys to automatically dial telephone numbers or to activate telephone system features.

### TO PROGRAM A SPEED DIAL KEY

1. Remove the faceplate and overlay if they are on the telephone base. Lift the handset, then press the recessed **PROGRAM** key. The **MUTE** key flashes when in administrator mode.
2. Press the desired Speed Dial key where the telephone number is to be stored. You hear a beep.
3. Enter the telephone number (up to 21 digits).
  - To insert a pause in the stored number, press the recessed **PAUSE** key.
4. The telephone stores the number automatically when 21 digits are entered. When the number has less than 21 digits, press the recessed **PROGRAM** key again. You hear a beep as confirmation. If the number is more than 21 digits, the target programming memory will be erased.

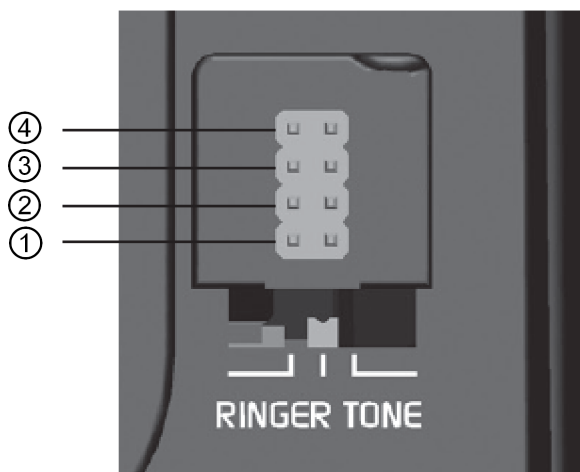

## Operation

### RECEIVE A CALL

When there is an incoming call, the telephone rings. The **MESSAGE WAITING** LED flashes.

To answer a call using the corded handset:

Lift the corded handset from the telephone base.

To answer a call using the telephone base:

On the telephone base, press **SPEAKER** key. The **SPEAKER** key illuminates when in speakerphone mode.

### PLACE A CALL

Lift the corded handset or press **SPEAKER** key on the telephone base. Listen for a dial tone and then dial the desired number, or press a Speed Dial key to dial a programmed number. The **SPEAKER** key illuminates when in speakerphone mode.

### END A CALL

Place the corded handset in the telephone base, or press **SPEAKER** key when in speakerphone mode.

### SHARE A CALL

During a call, parallel telephones (telephones on the same line) can join the call.

### JOIN A CALL

During a call, lift the corded handset to join.

### VOLUME

Listening volume and ringer volume can be adjusted from the telephone base.

#### ADJUST THE LISTENING VOLUME

During a call, press **+ / VOLUME** or **- / VOLUME** to adjust the listening volume. The next call returns to the default listening volume.

#### ADJUST THE RINGER VOLUME

At any time, slide the **RINGER VOL** switch on the right side of the telephone base to adjust the ringer volume.

### CALL WAITING

1. When you hear a call waiting tone during a call, press **FLASH** on the telephone base to put your current call on hold and take the new incoming call.
2. Press **FLASH** or the switch hook once rapidly at any time to switch back and forth between calls.

### MUTE

#### MUTE THE MICROPHONE

1. During a call, press **MUTE** on the telephone base. The **MUTE** key flashes when the mute function is turned on. You can hear the party on the other end but they cannot hear you.
2. Press **MUTE** again to resume the conversation. The light on the **MUTE** key turns off.

#### NOTE

- The **MUTE** key does not mute the ringer tone.

### HOLD

When a call is placed on hold, any parallel phone that tries to use the same phone line will take the call off hold and pick the call.

#### PLACE A CALL ON HOLD

1. During a call, press **HOLD** on the telephone base to place that call on hold. The **HOLD** illuminates in red when the call is placed on hold.
2. To release the call from hold, lift the handset from the telephone base cradle.

### SPEAKERPHONE

Press **SPEAKER** key on the telephone base to switch between speakerphone mode and handset earpiece mode.

# Appendix

## Troubleshooting

If you have difficulty with the telephones, please try the suggestions below. For customer service, call +44 (0)1706 694 070 or email [ukca@trustdistribution.com](mailto:ukca@trustdistribution.com).

QUESTION	SUGGESTION
1. The telephone does not work at all.	<ul style="list-style-type: none"><li>• Make sure the telephone line is plugged into the <b>TEL</b> port of the telephone base.</li><li>• Make sure the telephone line cord is plugged firmly into the telephone wall jack.</li><li>• Disconnect the telephone base from the telephone wall jack and plug in a working telephone. If the other telephone does not work, the problem is probably in the wiring or telephone service. Contact your telephone service provider (charges may apply).</li></ul>
2. There is no dial tone.	<ul style="list-style-type: none"><li>• Try all the above suggestions.</li><li>• The telephone line cord may be defective. Install a new telephone line cord.</li><li>• Disconnect the telephone base from the telephone wall jack and connect a different telephone. If there is no dial tone on this telephone either, the problem is in your wiring or telephone service. Contact your telephone service provider (charges may apply).</li></ul>
3. I cannot dial out.	<ul style="list-style-type: none"><li>• Try all the above suggestions.</li><li>• Make sure there is a dial tone before dialing.</li><li>• Eliminate any background noise. Mute the telephone before dialing, if applicable, or dial from another room in your unit with less background noise.</li><li>• If other telephones in your hotel are having the same problem, the problem is in the wiring or telephone service. Contact your telephone service provider (charges may apply).</li></ul>

QUESTION	SUGGESTION
4. The telephone does not ring when there is an incoming call.	<ul style="list-style-type: none"><li>• Make sure the telephone line cord is plugged in properly.</li><li>• If other telephones in your hotel are having the same problem, the problem is in the wiring or telephone service. Contact your telephone service provider (charges may apply).</li><li>• Test a working telephone at the telephone wall jack. If another telephone has the same problem, the problem is in the telephone wall jack. Contact your telephone service provider (charges may apply).</li><li>• The telephone line cord may be defective. Install a new telephone line cord.</li></ul>
5. There is interference during a telephone conversation.	<ul style="list-style-type: none"><li>• If there is High Speed Internet Access (HSIA) available at the premises through a telephone line, you may need to install a DSL filter (DSL - digital subscriber line) between the telephone line cord and the telephone wall jack. The filter prevents noise and caller ID problems caused by DSL interference. Contact your DSL service provider for more information about DSL filters.</li><li>• If your telephone is plugged in with a modem or a surge protector, plug the telephone (or modem/surge protector) into a different location. If this doesn't solve the problem, relocate your telephone or modem farther apart from each other, or use a different surge protector.</li><li>• Disconnect the telephone base from the telephone wall jack. Plug in a different telephone. If calls are still not clear, the problem is probably in the wiring or telephone service. Contact your telephone service provider (charges may apply).</li><li>• If other telephones in your hotel are having the same problem, the problem is in the wiring or telephone service. Contact your telephone service provider (charges may apply).</li></ul>

**QUESTION****SUGGESTION**

6. I hear other calls when using the telephone.

- Disconnect the telephone base from the telephone wall jack. Plug in a different telephone. If you still hear other calls, the problem is probably in the wiring or telephone service. Contact your telephone service provider (charges may apply).
-

## Appendix

### VTech Hospitality Limited Warranty Program

VTech Telecommunications Limited, the manufacturer of VTech Hospitality Product ("Product"), warrants to the holder of a valid proof of purchase ("end user" or "you") that the Product and all accessories provided by VTech in the Product's package are free from defects in material and workmanship, pursuant to the following terms and conditions, when installed and used normally and in accordance with the Product's operating instructions. The limited warranty extends to the end user of this Product and applies only if such Product is purchased through a local distributor / dealer.

During the limited warranty period, VTech's authorised service representative will repair or replace, at VTech's option, without charge, a Product that is not free from defects in materials and workmanship. If VTech's authorised service representative repairs the Product, new or refurbished replacement parts may be used. If the Product is replaced, it may be replaced with a new or refurbished Product of the same or similar design. Repair or replacement of Product, at VTech's option, is the exclusive remedy.

The limited warranty period for the Product begins on the date that the end user takes possession of the Product. This limited warranty also applies to repaired or replacement Products for a period of either: (a) 90 days from the date the repaired or replacement Product is shipped to you; or (b) the time remaining on the original limited warranty as described above; whichever is longer.

This limited warranty does not cover:

1. Product or parts that have been subjected to misuse, accident, shipping or other physical damage, improper installation, abnormal operation or handling, neglect, inundation, fire, water or other liquid intrusion; or
2. Product that has been damaged due to repair, alteration or modification by anyone other than an authorised service representative of VTech; or
3. Product to the extent that the problem experienced is caused by signal conditions, network reliability or cable or antenna systems; or
4. Product to the extent that the problem is caused by use with non-VTech accessories; or
5. Product whose warranty/quality stickers, product serial number plates or electronic serial numbers have been removed, altered or rendered illegible; or
6. Product purchased, used, serviced, or shipped for repair from outside the local dealer / distributor, or used for non-approved commercial or institutional purposes (including but not limited to Products used for rental purposes); or
7. Product returned without valid proof of purchase; or
8. Charges or costs incurred by the end user, and risk of loss or damage, in removing and shipping the Product, or for installation or set up, adjustment of customer controls, and installation or repair of systems outside the unit.
9. Line cords or coil cords, plastic overlays, connectors, power adapters and batteries, if the Product is returned without them. VTech will charge the end user at then-current prices for each of the missing items.
10. NiCd or NiMH handset batteries, or power adapters, which, under all circumstances, are covered

by a one (1) year warranty only.

Except as provided by applicable law, you assume the risk of loss or damage during transit and transportation and are responsible for delivery or handling charges incurred in the transport of Product(s) to the service location. VTech's authorised service representative will return repaired or replaced product under this limited warranty to you, transportation, delivery and handling charges prepaid. VTech assumes no risk for damage or loss of the Product in transit.

If the Product failure is not covered by this limited warranty, or proof of purchase does not meet the terms of this limited warranty, VTech will notify you and will request that you authorise the cost of repair and return shipping costs for the repair of Products that not covered by this limited warranty. You must pay for the cost of repair and return shipping costs for the repair of Products that are not covered by this limited warranty.

## OTHER LIMITATIONS

This warranty is the complete and exclusive agreement between you and VTech. It supersedes all other written or oral communications related to this Product. VTech provides no other warranties for this Product, whether express or implied, oral or written, or statutory. The warranty exclusively describes all of VTech's responsibilities regarding the Product. No one is authorised to make modifications to this warranty and you should not rely on any such modification.

VTech's liability to end user hereunder shall not exceed the purchase price of the Product. In no event shall VTech be liable for any indirect, special, incidental, consequential, or similar damages (including, but not limited to lost profits or revenue, inability to use the product, or other associated equipment, the cost of substitute equipment, and claims by third parties) resulting from the use of this Product. Some local dealers / distributors do not allow the exclusion or limitation of incidental or consequential damages, so the above limitation or exclusion may not apply to you.

This warranty gives you specific legal rights, and you also have other rights which vary from local dealer / distributor to local dealer / distributor.



## Maintenance

### TAKING CARE OF YOUR TELEPHONE

Your telephone contains sophisticated electronic parts, so it must be treated with care.

### AVOID ROUGH TREATMENT

Place the handset down gently. Save the original packing materials to protect your telephone if you ever need to ship it.

### AVOID WATER

Your telephone can be damaged if it gets wet. Do not use the handset outdoors in the rain, or handle it with wet hands. Do not install the telephone base near a sink, bathtub or shower.

### ELECTRICAL STORMS

Electrical storms can sometimes cause power surges harmful to electronic equipment. For your own safety, take caution when using electrical appliances during storms.

### CLEANING YOUR TELEPHONE

Your telephone has a durable plastic casing that should retain its luster for many years. Clean it only with a soft cloth slightly dampened with water or mild soap. Do not use excess water or cleaning solvents of any kind.

## Disclaimer and Limitation of Liability

VTech Telecommunications Limited and its suppliers assume no responsibility for any damage or loss resulting from the use of this user's manual. VTech Telecommunications Limited and its suppliers assume no responsibility for any loss or claims by third parties that may arise through the use of this product. VTech Telecommunications Limited and its suppliers assume no responsibility for any damage or loss caused by deletion of data as a result of malfunction, dead battery, or repairs. Be sure to make backup copies of important data on other media to protect against data loss.

**REMEMBER THAT ELECTRICAL APPLIANCES CAN CAUSE SERIOUS INJURY IF USED WHEN YOU ARE WET OR STANDING IN WATER. IF THE TELEPHONE BASE SHOULD FALL INTO WATER, DO NOT RETRIEVE IT UNTIL YOU UNPLUG THE POWER CORD AND/OR TELEPHONE LINE CORD FROM THE WALL. THEN REMOVE THE TELEPHONE BY THE UNPLUGGED CORDS.**

## European Directives

This equipment is compliant with 2014/53/EU (RED) and 2011/65/EU (ROHS).

## Declaration of Conformity

The Declaration of Conformity may be obtained from: [www.vtechhotelphones.com](http://www.vtechhotelphones.com).



## Disposal of batteries and product

These symbols (①, ②) on the products, packaging, and/or accompanying documents mean that used electrical and electronic products and batteries must not be mixed with general household waste.

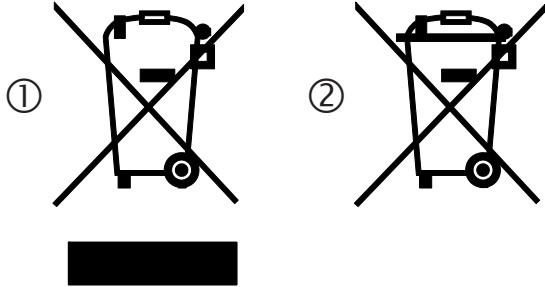

For proper treatment, recovery and recycling of old products and batteries, please take them to applicable collection points in accordance with your national legislation.

By disposing of them correctly, you will help to save valuable resources and prevent any potential negative effects on human health and the environment.

For more information about collection and recycling, please contact your local municipality. Penalties may be applicable for incorrect disposal of this waste, in accordance with national legislation.

## PRODUCT DISPOSAL INSTRUCTIONS FOR BUSINESS USERS

If you wish to discard electrical and electronic equipment, please contact your dealer or supplier for further information.

## INFORMATION ON DISPOSAL IN OTHER COUNTRIES OUTSIDE THE EUROPEAN UNION

These symbols (①, ②) are only valid in the European Union. If you wish to discard these items, please contact your local authorities or dealer and ask for the correct method of disposal.

## NOTE FOR THE BATTERY SYMBOL

This symbol (②) might be used in combination with a chemical symbol. In this case it complies with the requirement set by the Directive for the chemical involved.

## Technical specification

### Analogue Contemporary Petite 1-line Corded Hotel Telephone - A2211-SPK

Power requirement	Line powered 24V or 48V
Message waiting signal	Steady/periodic high voltage pulse or periodic low voltage pulse
Speed Dial memory	Telephone base: up to 10 memory locations; up to 21 digits
Size	Telephone base: 8.54 x 3.69 x 2.18 in (217 x 93.6 x 55.3 mm) Corded handset: 8.25 x 1.85 x 1.5 in (209.6 x 47 x 38.2 mm)
Manufacturer	VTech Telecommunications Limited Address: 23/F Tai Ping Industrial Centre, Block 1, 57 Ting Kok Road, Tai Po, Hong Kong



Specifications are subject to change without notice.  
VTech Telecommunications Limited  
All rights reserved. 5/24.  
A2211-SPK\_UG\_V1\_CEC\_EU-UK\_7MAY2024  
Copyright © 2024