



## **Analog Contemporary Series User's Guide (EU version)**

### Models:

- Analog corded lobby hotel telephone - A2100,
- Analog corded 1-line hotel telephone - A2210,
- Analog corded 2-line hotel telephone - A2220,
- Analog corded trimstyle hotel telephone - A2310,
- Analog cordless 1-line hotel telephone - A2410/CTM-A2411/CTM-A2411-BATT,
- Analog cordless 2-line hotel telephone - A2420/CTM-A2421/CTM-A2421-BATT,
- Analog corded/cordless 1-line hotel telephone - CTM-A2510/CTM-A2510-USB,
- Analog cordless charging base - C4000/C4001,
- Analog cordless charging stand - C4010/C4011/C4011-USB,
- Analog cordless 1-line accessory handset - C4100/CTM-C4101,
- Analog cordless 2-line accessory handset - C4200/CTM-C4201,
- Analog cordless 1-line accessory Petite™ - CTM-A241P,
- Analog cordless 2-line accessory Petite™ - CTM-A242P,
- Analog cordless 1-line accessory handset and charger bundle - CTM-A241HS,
- Analog cordless 2-line accessory handset and charger bundle - CTM-A242HS,
- Analog cordless 1-line accessory handset with speed dials and charger bundle - CTM-A241SD, and
- Analog cordless 2-line accessory handset with speed dials and charger bundle - CTM-A242SD



## Important safety instructions

When using your telephone equipment, basic safety precautions should always be followed to reduce the risk of fire, electric shock and injury, including the following:

1. This product should be installed by a qualified technician.
2. This product should only be connected to the host equipment and never directly to the network such as Public Switch Telephone Network (PSTN) or Plain Old Telephone Services (POTS).
3. Read and understand all instructions.
4. Follow all warnings and instructions marked on the product.
5. Unplug this product from the wall outlet before cleaning. Do not use liquid or aerosol cleaners. Use a damp cloth for cleaning.
6. Do not use this product near water such as near a bath tub, wash bowl, kitchen sink, laundry tub or swimming pool, or in a wet basement or shower.
7. Do not place this product on an unstable table, shelf, stand or other unstable surfaces.
8. Slots and openings in the back or bottom of the telephone base and handset are provided for ventilation. To protect them from overheating, these openings must not be blocked by placing the product on a soft surface such as a bed, sofa or rug. This product should never be placed near or over a radiator or heat register. This product should not be placed in any area where proper ventilation is not provided.
9. This product should be operated only from the type of power source indicated on the marking label. If you are not sure of the type of power supply on the premises, consult your dealer or local power company.
10. Do not allow anything to rest on the power cord. Do not install this product where the cord may be walked on.
11. Never push objects of any kind into this product through the slots in the telephone base or handset because they may touch dangerous voltage points or create a short circuit. Never spill liquid of any kind on the product.
12. To reduce the risk of electric shock, do not disassemble this product, but take it to an authorized service facility. Opening or removing parts of the telephone base or handset other than specified access doors may expose you to dangerous voltages or other risks. Incorrect reassembling can cause electric shock when the product is subsequently used.
13. Do not overload wall outlets and extension cords.
14. Unplug this product from the wall outlet and refer servicing to an authorized service facility under the following conditions:
  - When the power supply cord or plug is damaged or frayed.
  - If liquid has been spilled onto the product.
  - If the product has been exposed to rain or water.
  - If the product does not operate normally by following the operating instructions. Adjust only those controls that are covered by the operation instructions. Improper adjustment of other controls may result in damage and often requires extensive work by an authorized technician to restore the product to normal operation.
  - If the product has been dropped and the telephone base and/or handset has been damaged.
  - If the product exhibits a distinct change in performance.
15. Avoid using a telephone (other than cordless) during an electrical storm. There is a remote risk of electric shock from lightning.
16. Do not use the telephone to report a gas leak in the vicinity of the leak. Under certain circumstances, a spark may be created when the adapter is plugged into the power outlet, or when the handset is replaced in its cradle. This is a common event associated with the closing of any electrical circuit. The user should not plug the phone into a power outlet, and should not put a charged handset into the cradle, if the phone is located in an environment containing concentrations of flammable or flame-supporting gases, unless there is adequate ventilation. A spark in such an environment could create a fire or explosion. Such environments might include: medical use of oxygen without adequate ventilation; industrial gases (cleaning solvents; gasoline vapors; etc.); a leak of natural gas; etc.
17. Only put the handset of your telephone next to your ear when it is in normal talk mode.
18. The power adapters are intended to be correctly oriented in a vertical or floor mount position. The prongs are not designed to hold the plug in place if it is plugged into a ceiling, under-the-table or cabinet outlet.
19. For pluggable equipment, the socket-outlet (power adapter) shall be installed near the equipment and shall be easily accessible.
20. Use only the power cord and batteries indicated in this manual. Do not dispose of batteries in a fire. They may explode. Check with local codes for possible special disposal instructions.
21. In wall mounting position, make sure to mount the telephone base on the wall by aligning the eyelets with the mounting studs of the wall plate. Then slide the telephone base down on both mounting studs until it locks into place. Refer to the full instructions in **Installation** in the user's manual.
22. CAUTION: Keep small metallic objects such as pins and staples away from the handset receiver.
23. CAUTION: There may be a risk of explosion if a wrong type of handset battery is used (A2410, A2420, C4100, C4200, CTM-A241HS, CTM-A241SD, CTM-A242HS, CTM-A242SD, CTM-A2411, CTM-A2411-BATT, CTM-A2421, CTM-A2421-BATT, CTM-A2510, CTM-A2510-USB, CTM-C4101 and CTM-C4201). Use only the supplied rechargeable battery (BT264392/ BT266342) or replacement battery (BT266342). Dispose of used batteries according to the information in Product disposal instructions in the user's manual.
24. Never dispose of batteries in a fire. There is a serious risk of explosion and/or the release of highly toxic chemicals.









































**SAVE THESE INSTRUCTIONS**

# Table of contents

<b>Parts checklist</b> .....	<b>1</b>
<b>Telephone layout</b> .....	<b>5</b>
Analog corded lobby - A2100.....	5
Analog corded 1-line - A2210.....	6
Analog corded 2-line - A2220.....	7
Analog corded trimstyle - A2310.....	8
Analog cordless 1-line - A2410.....	9
Analog cordless 1-line - CTM-A2411/CTM-A2411-BATT.....	10
Analog cordless 1-line accessory Petite - CTM-A241P.....	11
Analog cordless 2-line - A2420.....	12
Analog cordless 2-line - CTM-A2421/CTM-A2421-BATT.....	13
Analog cordless 2-line accessory Petite - CTM-A242P.....	14
Analog corded/cordless 1-line - CTM-A2510.....	15
Analog corded/cordless 1-line - CTM-A2510-USB.....	16
Analog cordless charging base - C4000/C4001.....	17
Analog cordless charging stand - C4010/C4011.....	18
Analog cordless charging stand - C4011-USB.....	19
Analog cordless 1-line accessory handset - C4100.....	20
Analog cordless 1-line accessory handset - CTM-C4101.....	21
Analog cordless 1-line accessory handset and charger bundle - CTM-A241HS.....	22
Analog cordless 1-line accessory handset with speed dials and charger bundle - CTM-A241SD.....	23
Analog cordless 2-line accessory handset - C4200.....	24
Analog cordless 2-line accessory handset - CTM-C4201.....	25
Analog cordless 2-line accessory handset and charger bundle - CTM-A242HS.....	26
Analog cordless 2-line accessory handset with speed dials and charger bundle - CTM-A242SD.....	27
<b>Installation</b> .....	<b>28</b>
Analog corded lobby/1-line/2-line - A2100/A2210/A2220.....	28
Analog corded trimstyle - A2310.....	30
Analog cordless 1-line/2-line - A2410/CTM-A2411/A2420/CTM-A2421.....	32
Analog cordless 1-line/2-line - CTM-A2411-BATT/CTM-A2421-BATT.....	34
Analog cordless 1-line/2-line - A2410/A2420.....	37
Analog cordless 1-line/2-line - CTM-A2411/CTM-A2411-BATT/CTM-A2421/CTM-A2421-BATT.....	39
Analog cordless 1-line/2-line accessory Petite - CTM-A241P/CTM-A242P.....	41
Analog corded/cordless 1-line - CTM-A2510/CTM-A2510-USB.....	44
Analog cordless charging base - C4000.....	49
Analog cordless charging base - C4001.....	50
Analog cordless charging stand - C4010.....	51
Analog cordless charging stand - C4011/C4011-USB/CTM-A241HS/CTM-A241SD/CTM-A242HS/CTM-A242SD.....	52
Analog cordless 1-line/2-line accessory handset - C4100/C4200/CTM-A241HS/CTM-A242HS.....	53
Analog cordless 1-line/2-line accessory handset - CTM-A241SD/CTM-A242SD/CTM-C4101/CTM-C4201.....	55
<b>Telephone settings</b> .....	<b>57</b>
Analog corded lobby/1-line/2-line/trimstyle - A2100/A2210/A2220/A2310.....	57
Analog cordless 1-line/2-line - A2410/CTM-A2411/CTM-A2411-BATT/A2420/CTM-A2421/CTM-A2421-BATT.....	59
Analog corded/cordless 1-line - CTM-A2510/CTM-A2510-USB.....	59
Analog cordless 1-line/2-line accessory handset - CTM-A241SD/CTM-A242SD/CTM-C4101/CTM-C4201.....	59
Analog cordless 1-line/2-line accessory Petite - CTM-A241P/CTM-A242P.....	59
<b>Telephone operation</b> .....	<b>63</b>
Analog corded lobby - A2100.....	63
Analog corded 1-line - A2210.....	64
Analog corded 2-line - A2220.....	66
Analog corded trimstyle - A2310.....	68
Analog cordless 1-line - A2410/CTM-A2411/CTM-A2411-BATT.....	69
Analog cordless 1-line accessory Petite - CTM-A241P.....	72
Analog cordless 2-line - A2420/CTM-A2421/CTM-A2421-BATT.....	73
Analog cordless 2-line accessory Petite - CTM-A242P.....	76
Analog corded/cordless 1-line - CTM-A2510/CTM-A2510-USB.....	78
<b>Appendix</b> .....	<b>81</b>
Handset battery.....	81
Troubleshooting.....	82
VTech Hospitality limited warranty program.....	85
Important note.....	86
Environmental notes.....	86
Product disposal instructions.....	86
Technical information.....	86
R&TTE.....	86
Maintenance.....	87
Technical specifications.....	88
<b>Index</b> .....	<b>94</b>













































# Parts checklist

Items contained in the respective telephone package:

Model name	Model number	Parts included
Analog corded lobby	A2100	 Telephone base with faceplate and overlay  Corded handset  Mounting bracket  Telephone line cord
Analog corded 1-line	A2210	 Telephone base with faceplate and overlay  Corded handset  Mounting bracket  Telephone line cord
Analog corded 2-line	A2220	 Telephone base with faceplate and overlay  Corded handset  Mounting bracket  Telephone line cord
Analog corded trimstyle	A2310	 Telephone base with faceplate and overlay  Corded handset  Mounting bracket  Telephone line cords (2)
Analog cordless 1-line	A2410	 Telephone base with faceplate and overlay  Cordless handset  Mounting bracket  Battery  Screw  Power adapter with RJ-45 cord  Telephone line cord
Analog cordless 1-line	CTM-A2411	 Telephone base with faceplate and overlay  Cordless handset  Mounting bracket  Battery  Screws (2)  Power adapter with RJ-45 cord  Telephone line cord
Analog cordless 1-line	CTM-A2411-BATT	 Telephone base with faceplate and overlay  Cordless handset  Mounting bracket  Batteries (2)  Screws (2)  Power adapter with RJ-45 cord  Telephone line cord
Analog cordless 1-line accessory Petite	CTM-A241P	 Telephone base with faceplate and overlay  Corded handset  Mounting bracket  Power adapter





























# Parts checklist

Items contained in the respective telephone package:

Model name	Model number	Parts included
Analog cordless 2-line	A2420	       <p>Telephone base with faceplate and overlay    Cordless handset    Mounting bracket    Battery    Screw    Power adapter with RJ-45 cord    Telephone line cord</p>
Analog cordless 2-line	CTM-A2421	       <p>Telephone base with faceplate and overlay    Cordless handset    Mounting bracket    Battery    Screws (2)</p> <p>Power adapter with RJ-45 cord    Telephone line cord</p>
Analog cordless 2-line	CTM-A2421-BATT	       <p>Telephone base with faceplate and overlay    Cordless handset    Mounting bracket    Batteries (2)    Screws (2)</p> <p>Power adapter with RJ-45 cord    Telephone line cord</p>
Analog cordless 2-line accessory Petite	CTM-A242P	    <p>Telephone base with faceplate and overlay    Corded handset    Mounting bracket    Power adapter</p>
Analog corded/cordless 1-line	CTM-A2510	          <p>Telephone base with faceplate and overlay    Corded handset    Cordless handset    Mounting bracket    Battery    Screws (2)</p> <p>Telephone line cord    Charging stand    Charger power adapter    Power adapter with RJ-45 cord</p>
Analog corded/cordless 1-line	CTM-A2510-USB	          <p>Telephone base with faceplate and overlay    Corded handset    Cordless handset    Mounting bracket    Battery    Screws (2)</p> <p>Telephone line cord    Charging stand    Charger power adapter    Power adapter with RJ-45 cord</p>















## Parts checklist

Items contained in the respective telephone package:

Model name	Model number	Parts included
Analog cordless charging base	C4000	   Charging base    Mounting bracket with a screw    Power adapter with RJ-45 cord
Analog cordless charging base	C4001	   Charging base    Mounting bracket with a screw    Power adapter
Analog cordless charging stand	C4010	  Charging stand    Power adapter with RJ-45 cord
Analog cordless charging stand	C4011	  Charging stand    Power adapter
Analog cordless charging stand	C4011-USB	  Charging stand    Power adapter
Analog cordless 1-line accessory handset	C4100	   Cordless handset    Battery    Screw
Analog cordless 1-line accessory handset	CTM-C4101	   Cordless handset    Battery    Screws (2)
Analog cordless 2-line accessory handset	C4200	   Cordless handset    Battery    Screw
Analog cordless 2-line accessory handset	CTM-C4201	   Cordless handset    Battery    Screws (2)
Analog cordless 1-line accessory handset and charger bundle	CTM-A241HS	     Cordless handset    Battery    Screw    Charging stand    Power adapter

## Parts checklist

Items contained in the respective telephone package:

Analog cordless 2-line accessory handset and charger bundle	CTM-A242HS					
		Cordless handset	Battery	Screw	Charging stand	Power adapter
Analog cordless 1-line accessory handset with speed dials and charger bundle	CTM-A241SD					
		Cordless handset	Battery	Screws (2)	Charging stand	Power adapter
Analog cordless 2-line accessory handset with speed dials and charger bundle	CTM-A242SD					
		Cordless handset	Battery	Screws (2)	Charging stand	Power adapter

Use only the provided battery and power adapter.

A2410/A2420		CTM-A2411/CTM-A2421		CTM-A2411-BATT/ CTM-A2421-BATT		CTM-A241P/ CTM-A242P
Battery	Base power adapter	Battery	Base power adapter	Battery	Base power adapter	Base power adapter
AAA x 2		AAA x 2		AAA x 4		--⎓+
2.4V	6VDC	2.4V	6VDC	2.4V	6VDC	5.1VDC
550mAh	600mA	550mAh	600mA	550mAh	600mA	1.3A
NiMH	RJ-45	NiMH	RJ-45	NiMH	RJ-45	

CTM-A2510			CTM-A2510-USB		
Battery	Base power adapter	Charging stand power adapter	Battery	Base power adapter	Charging stand power adapter
AAA x 2		--⎓+	AAA x 2		--⎓+
2.4V	6VDC	6VDC	2.4V	6VDC	6VDC
550mAh	600mA	450mA	550mAh	600mA	1400mA
NiMH	RJ-45		NiMH	RJ-45	

C4000	C4001	C4010	C4011	C4011-USB	C4100/ CTM-C4101/ C4200/ CTM-C4201	CTM-A241HS/ CTM-A242HS/ CTM-A241SD/ CTM-A242SD	
Charging base power adapter	Charging base power adapter	Charging stand power adapter	Charging stand power adapter	Charging stand power adapter	Battery	Battery	Charging stand power adapter
	--⎓+		--⎓+	--⎓+	AAA x 2	AAA x 2	--⎓+
6VDC	6VDC	6VDC	6VDC	6VDC	2.4V	2.4V	6VDC
600mA	450mA	600mA	450mA	1400mA	550mAh	550mAh	450mA
RJ-45		RJ-45			NiMH	NiMH	



# Telephone layout

## Analog corded lobby - A2100

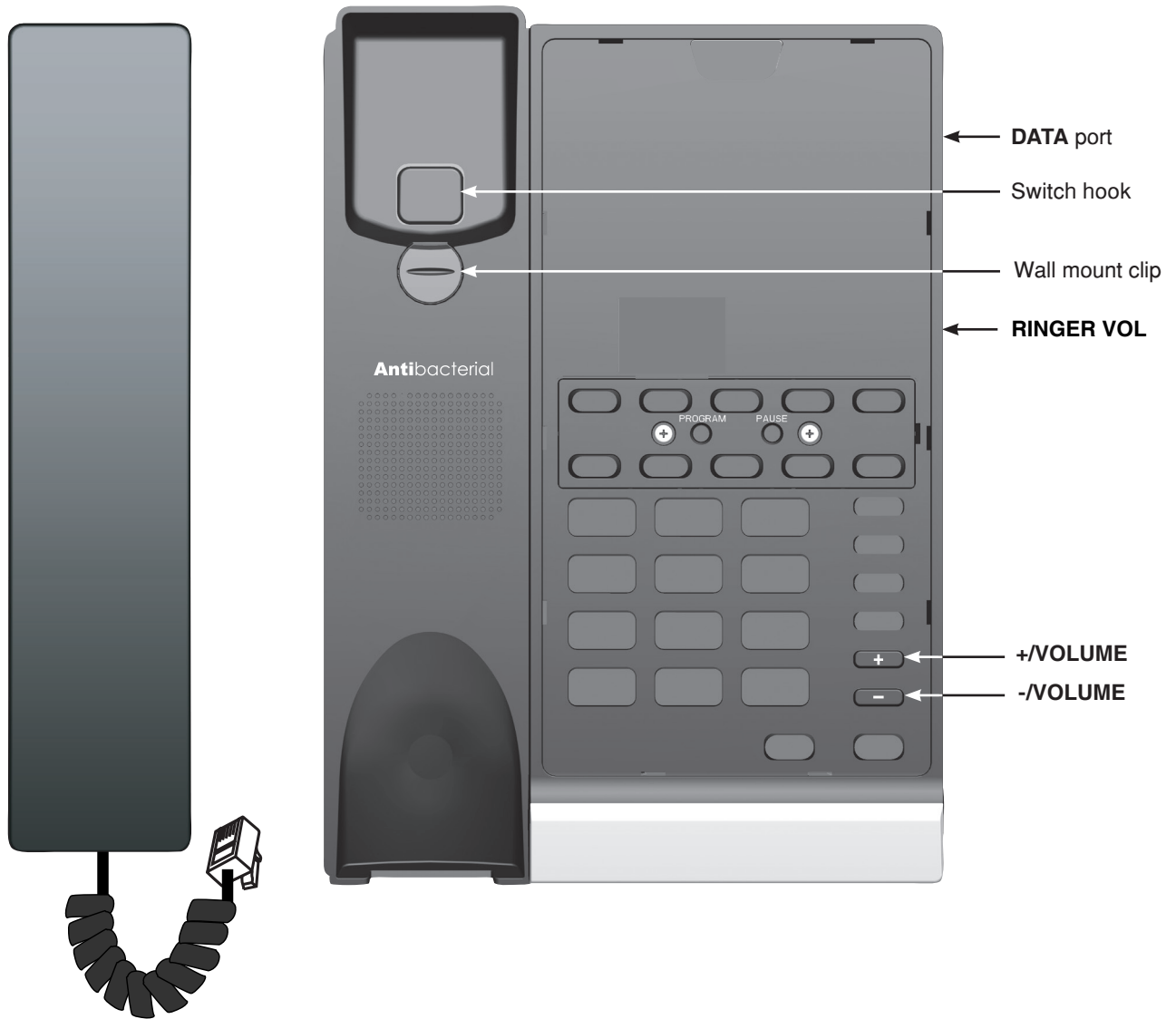

Telephone layout

# Telephone layout

## Analog corded 1-line - A2210



# Telephone layout

## Analog corded 2-line - A2220

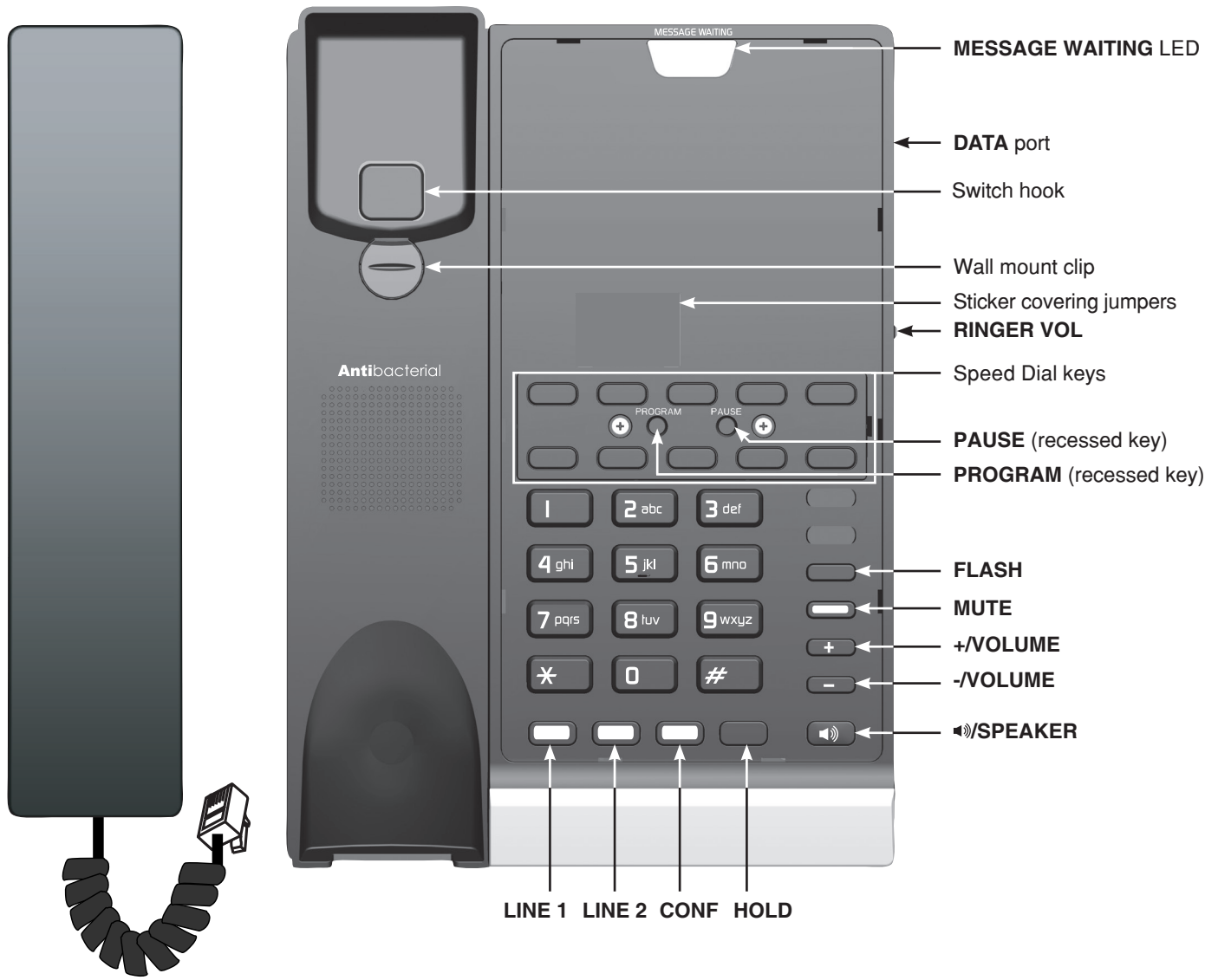

Telephone layout

**NOTE:** Make sure **LINE 1** is connected to maintain normal telephone operation.

# Telephone layout

## Analog corded trimstyle - A2310



# Telephone layout

## Analog cordless 1-line - A2410

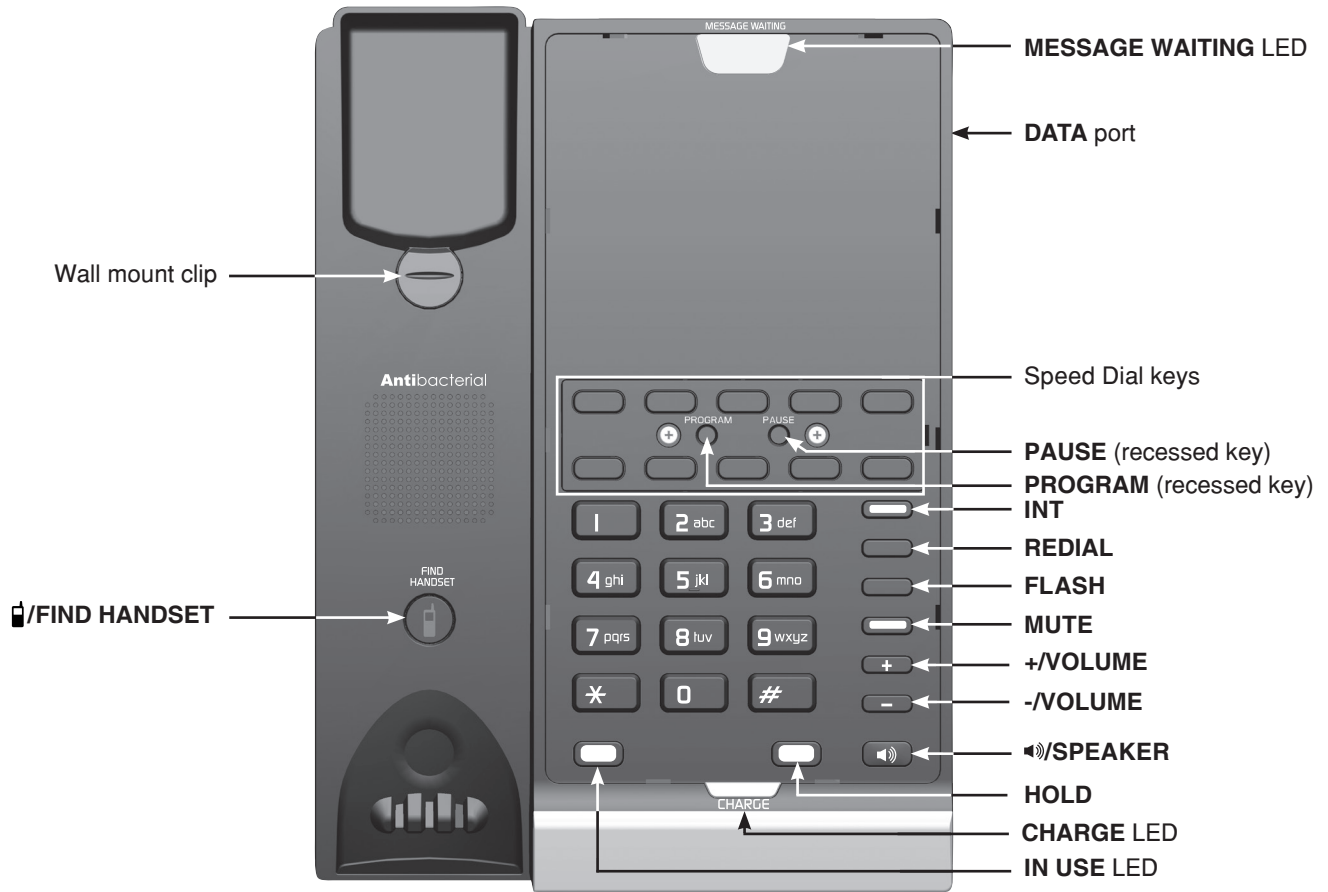

Telephone layout

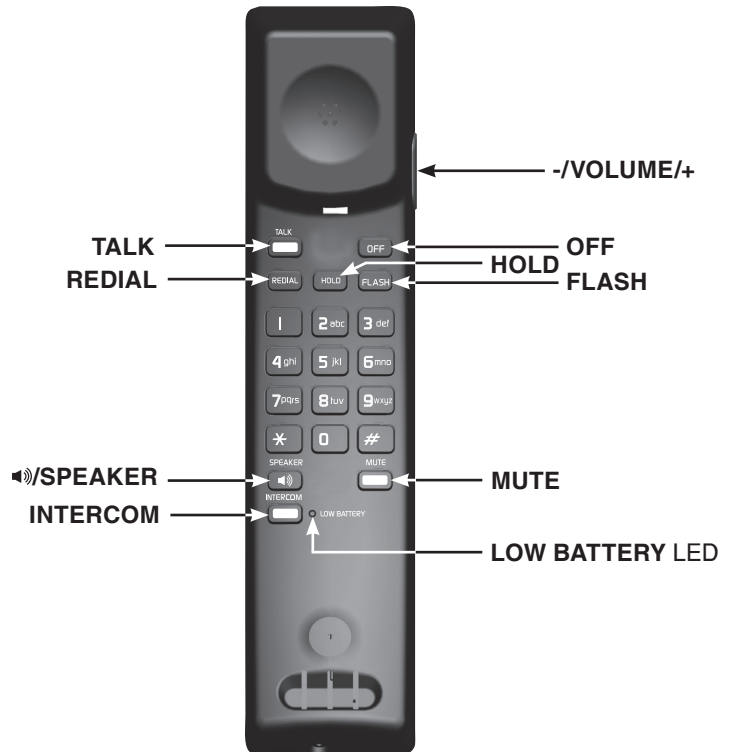
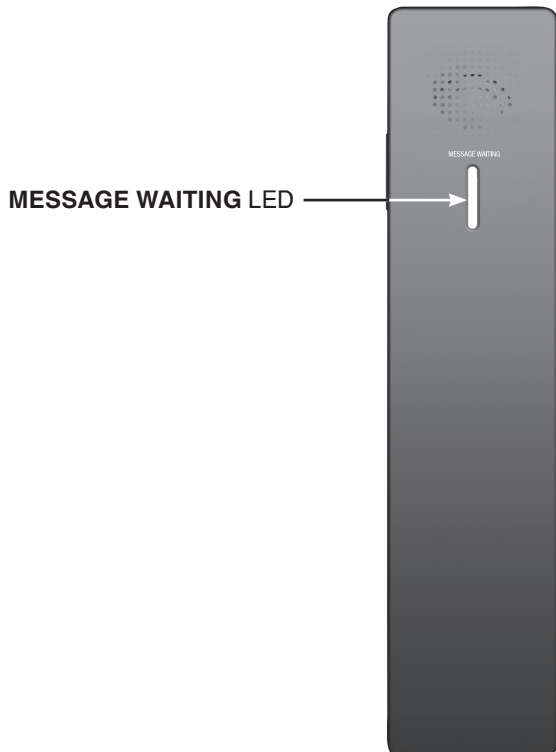

# Telephone layout

## Analog cordless 1-line - CTM-A2411/CTM-A2411-BATT

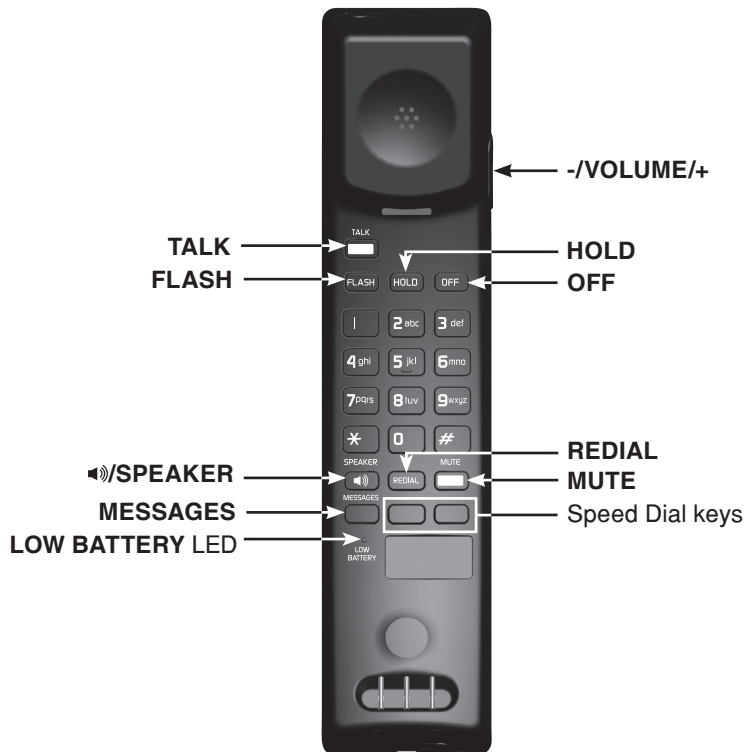
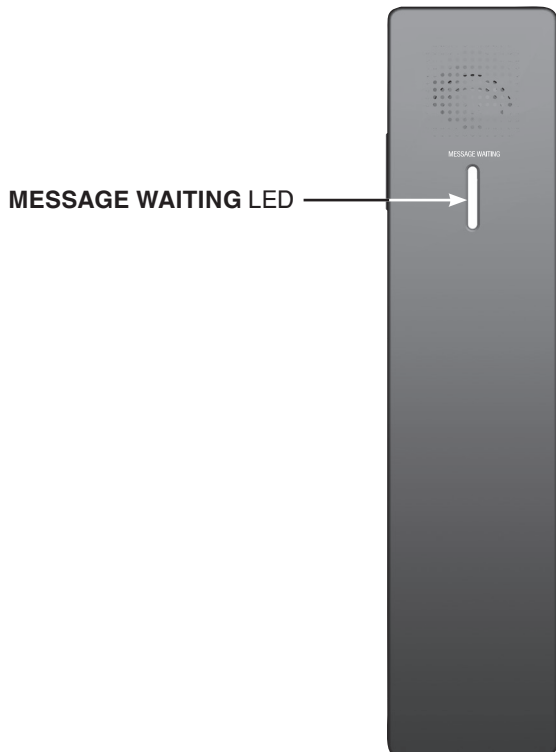

# Telephone layout

## Analog cordless 1-line accessory Petite - CTM-A241P

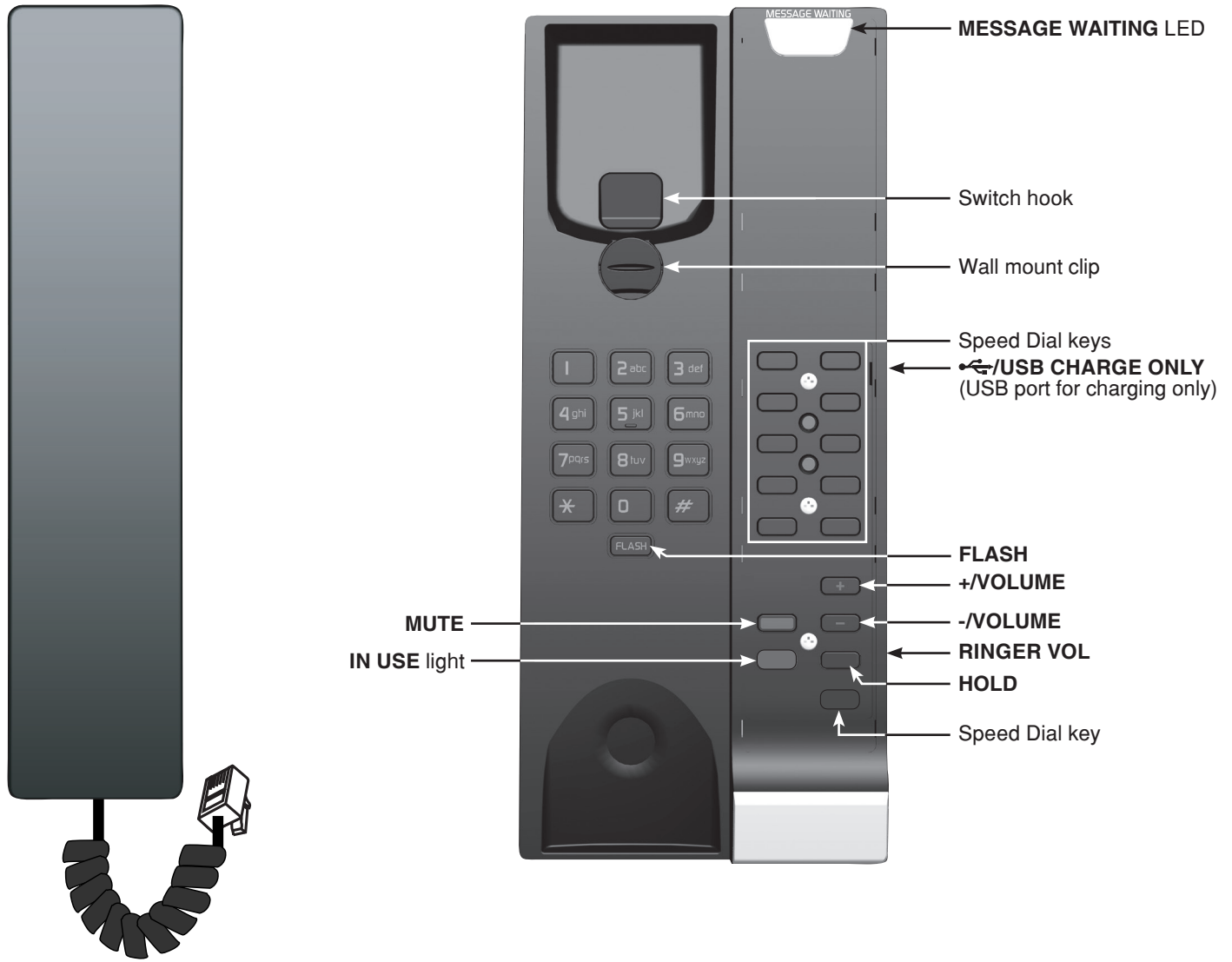

Telephone layout

# Telephone layout

## Analog cordless 2-line - A2420

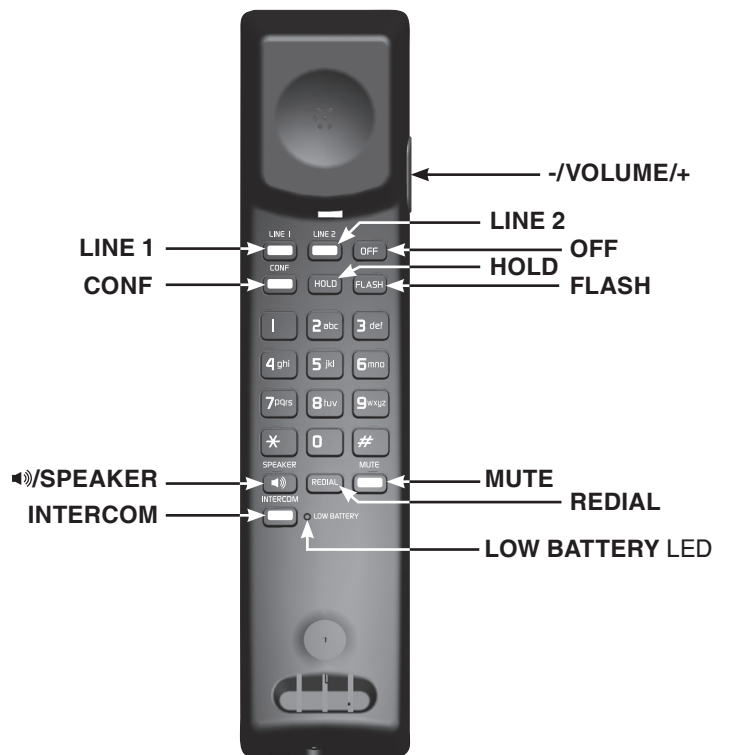
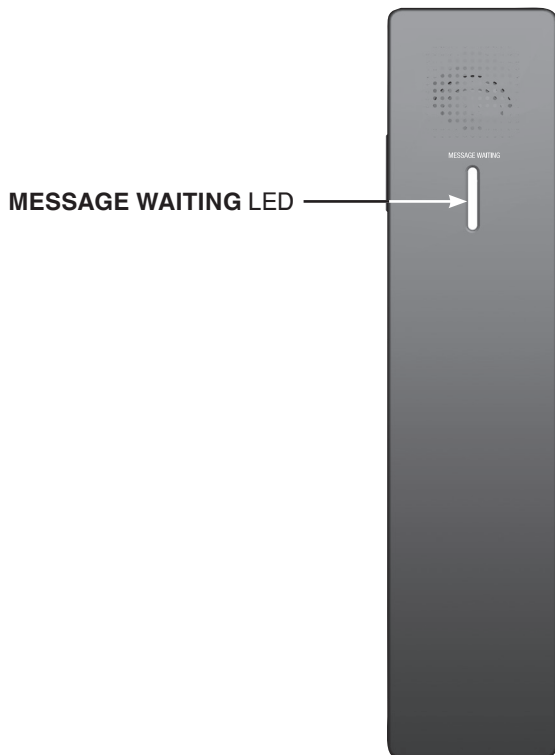
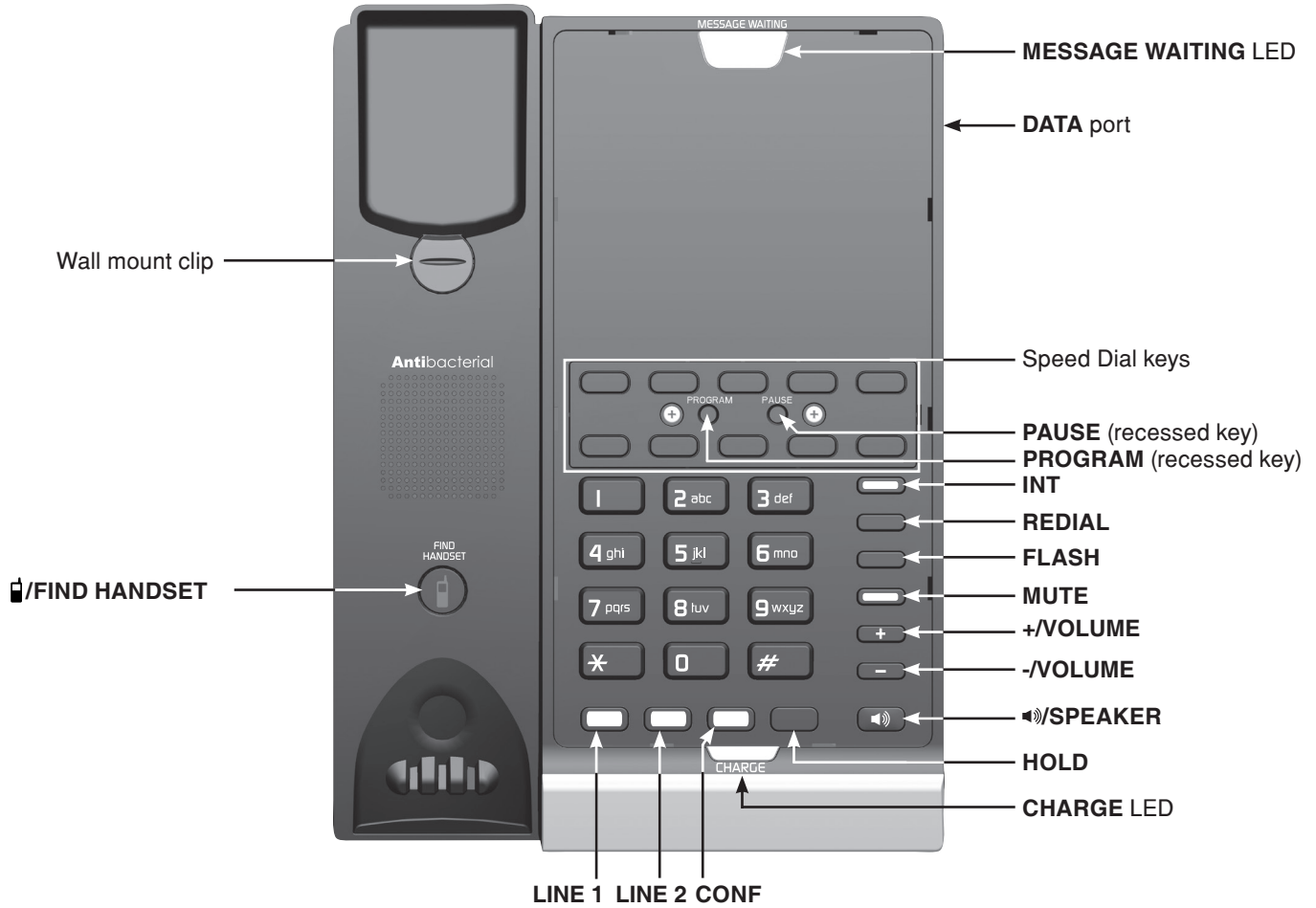



# Telephone layout

## Analog cordless 2-line - CTM-A2421/CTM-A2421-BATT

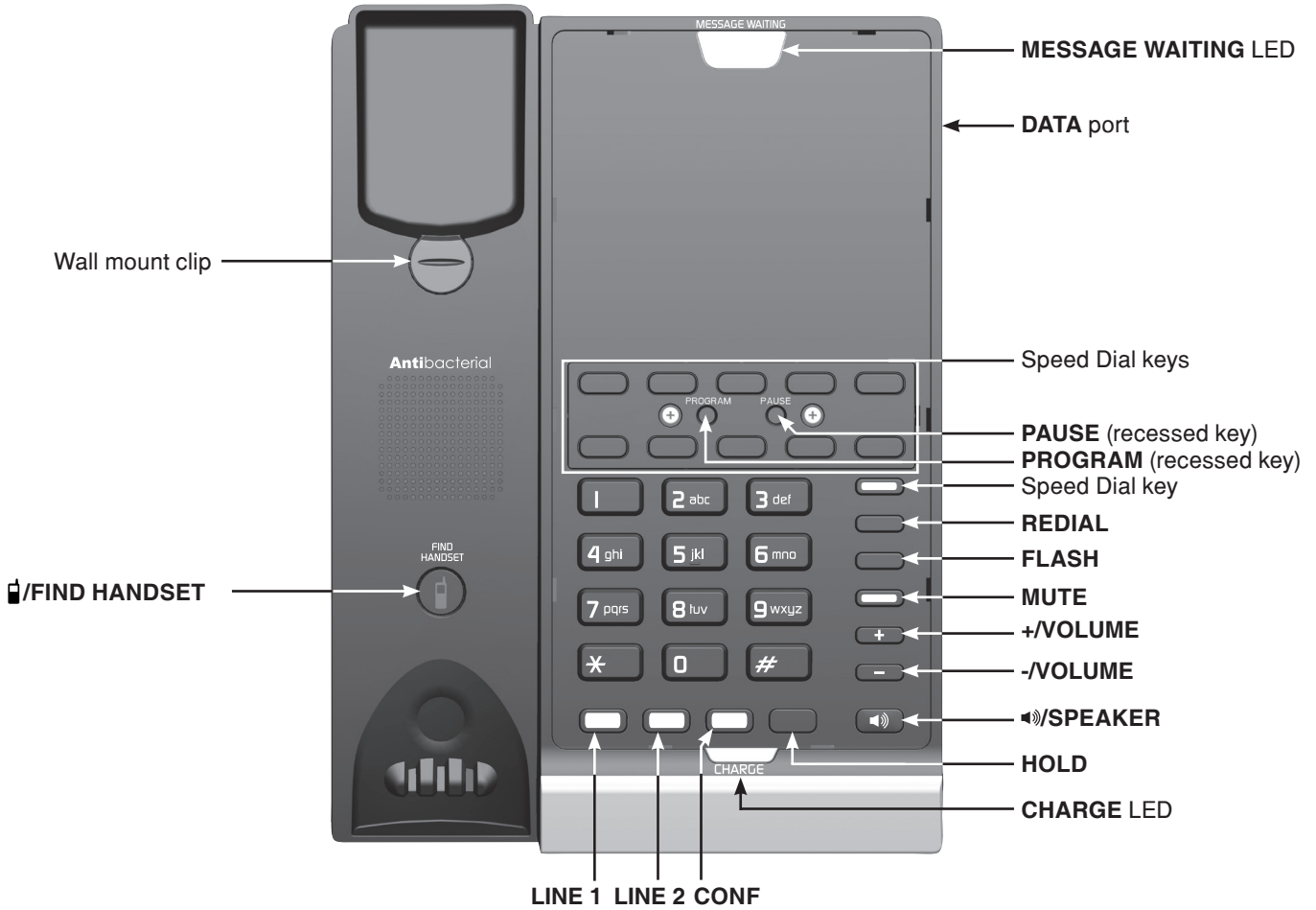

Telephone layout

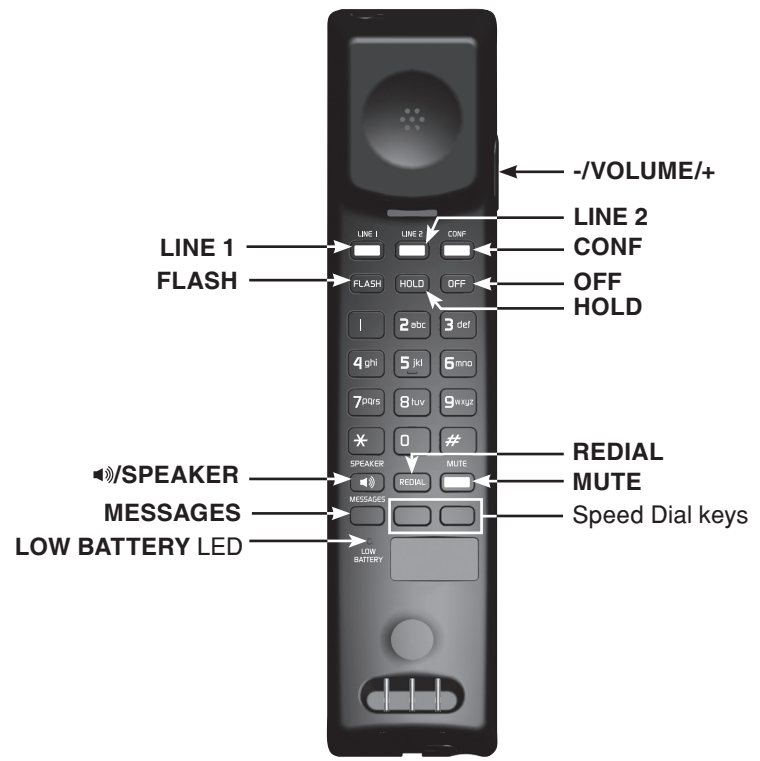
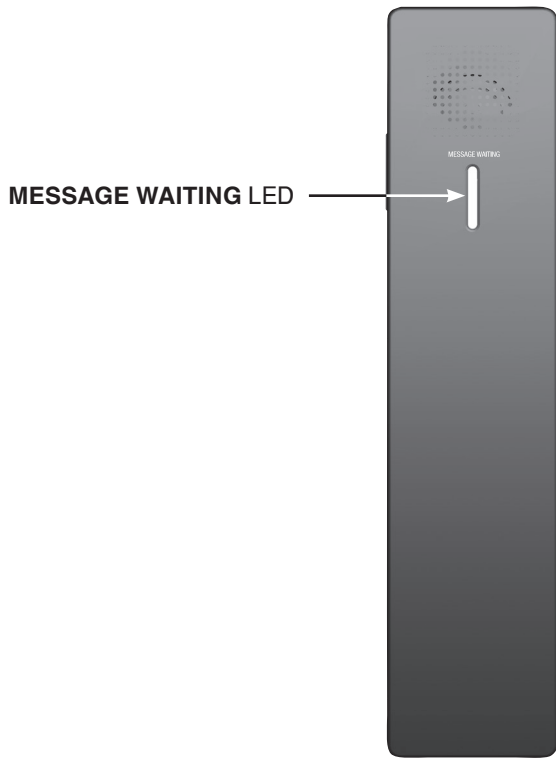

# Telephone layout

## Analog cordless 2-line accessory Petite - CTM-A242P

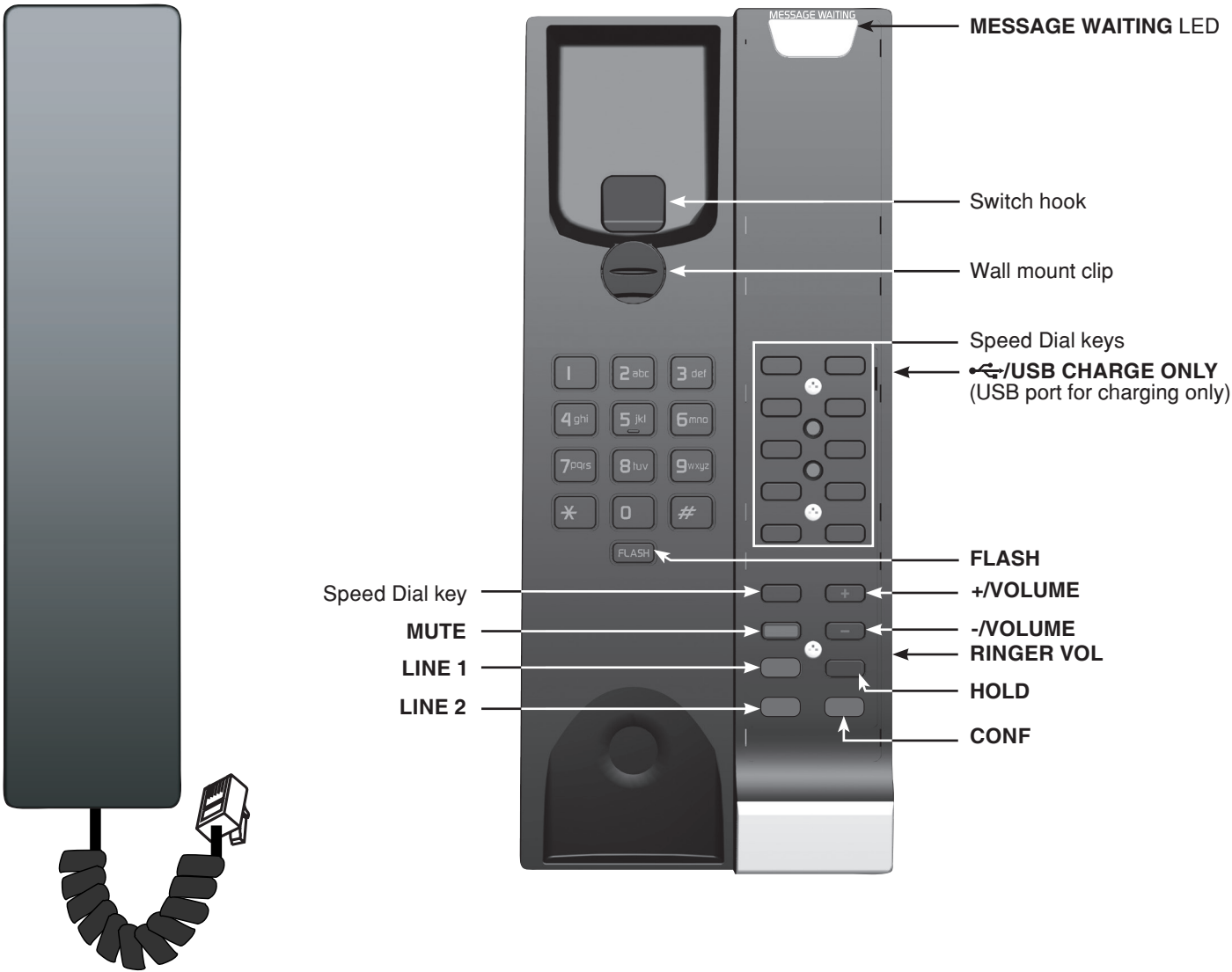

# Telephone layout

## Analog corded/cordless 1-line - CTM-A2510

Telephone layout

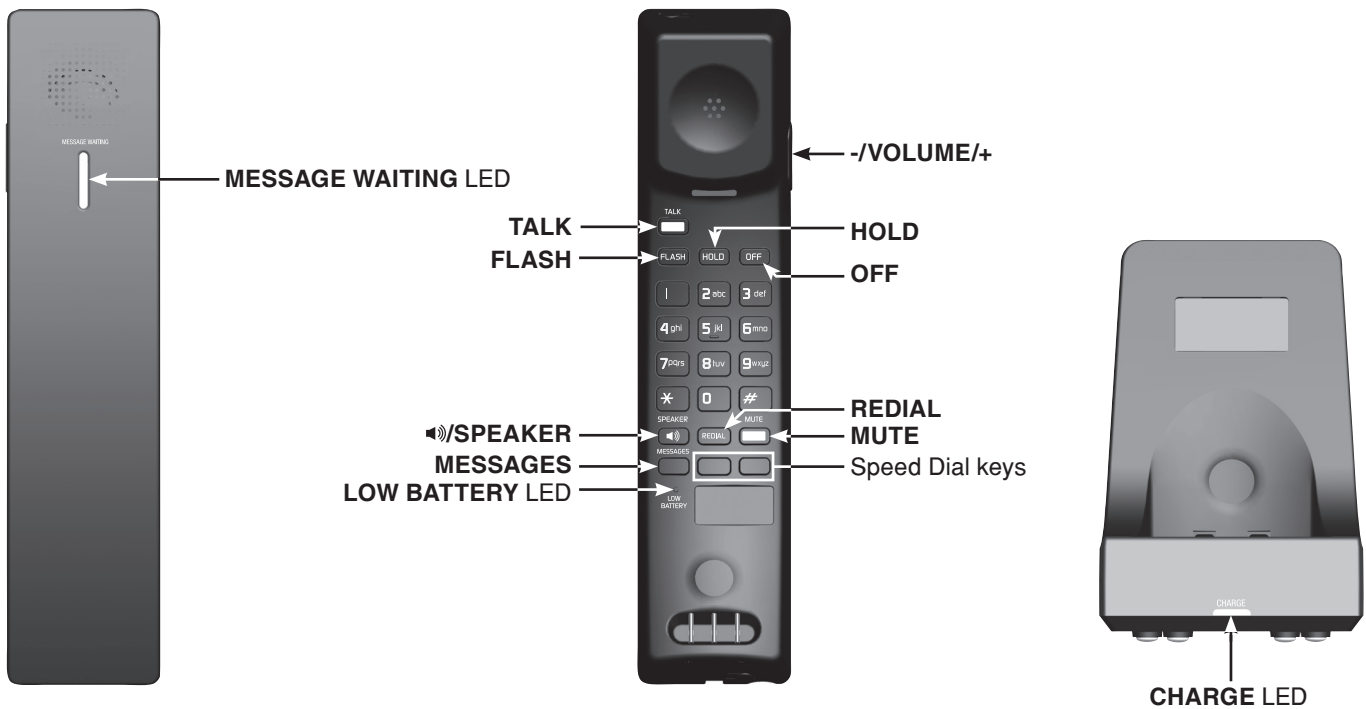
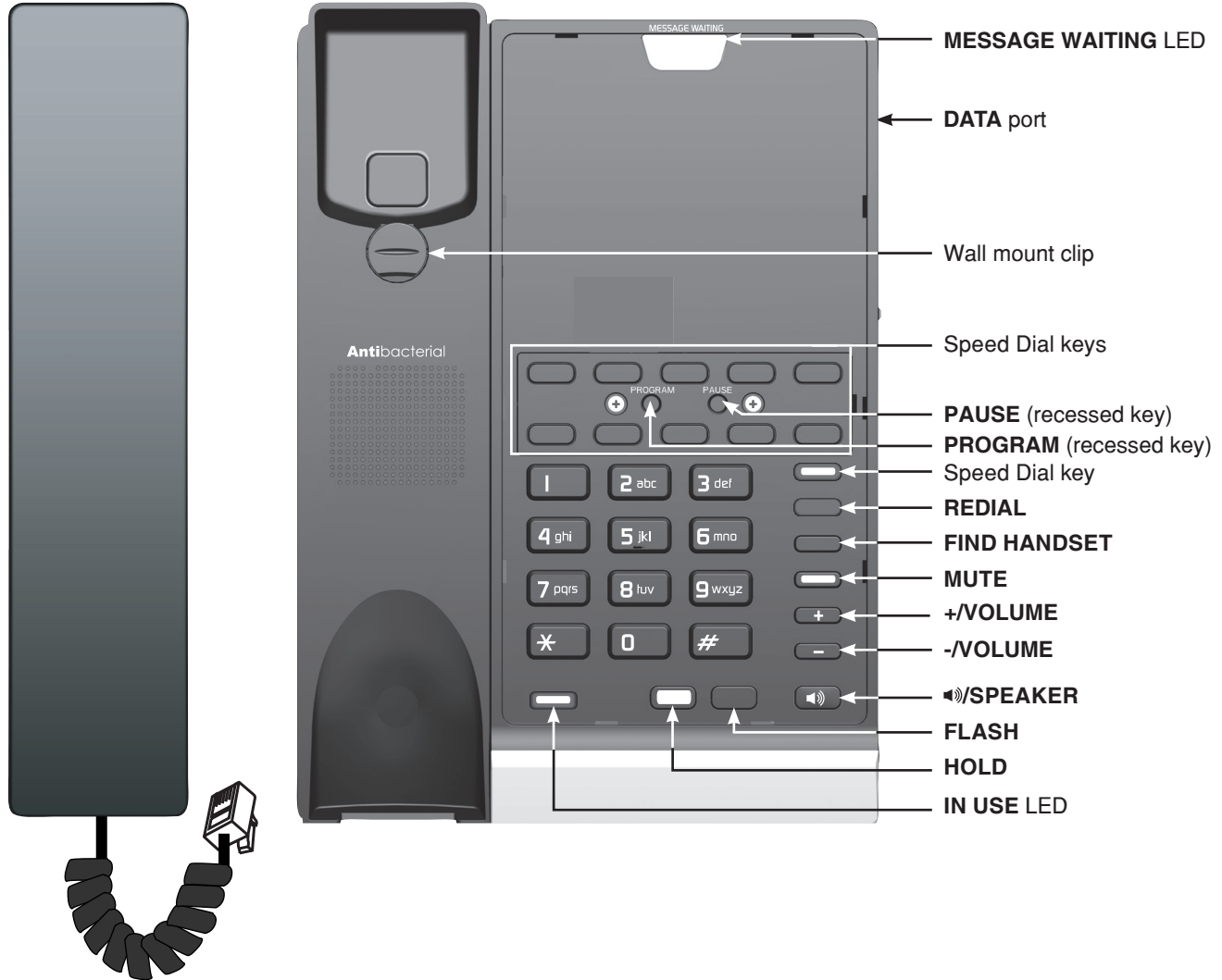

# Telephone layout

## Analog corded/cordless 1-line - CTM-A2510-USB

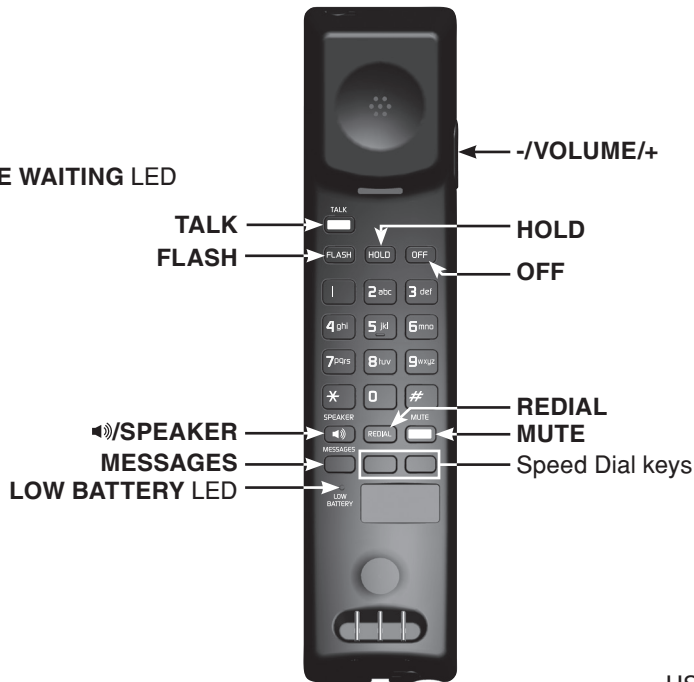

# Telephone layout

## Analog cordless charging base - C4000/C4001

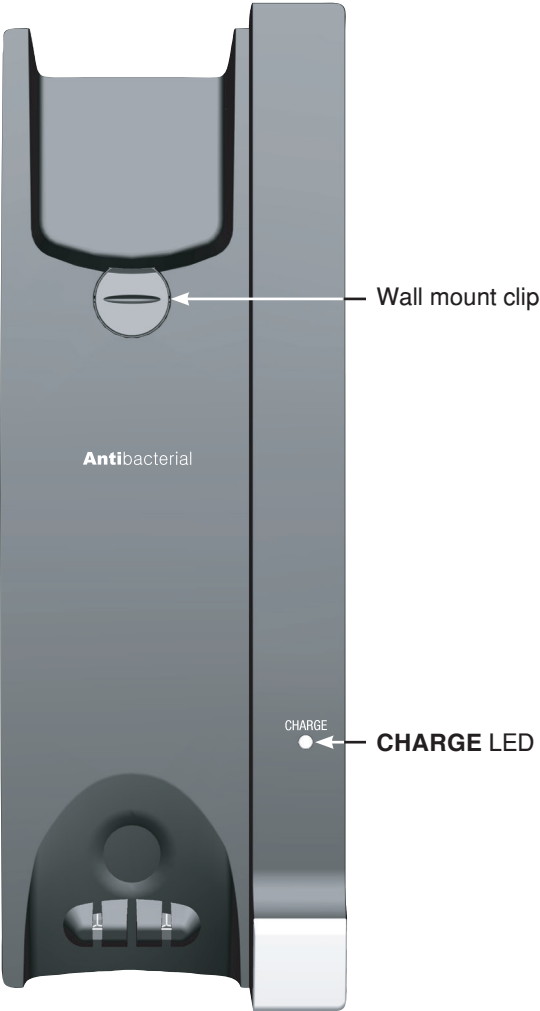

Telephone layout

# Telephone layout

## Analog cordless charging stand - C4010/C4011



**CHARGE LED**

## Telephone layout

### Analog cordless charging stand - C4011-USB



CHARGE LED



USB charging port (For charging only)

#### NOTE

- The USB charging port on the side of the stand is used for charging devices (up to 1A @ 5.1V).

# Telephone layout

## Analog cordless 1-line accessory handset - C4100

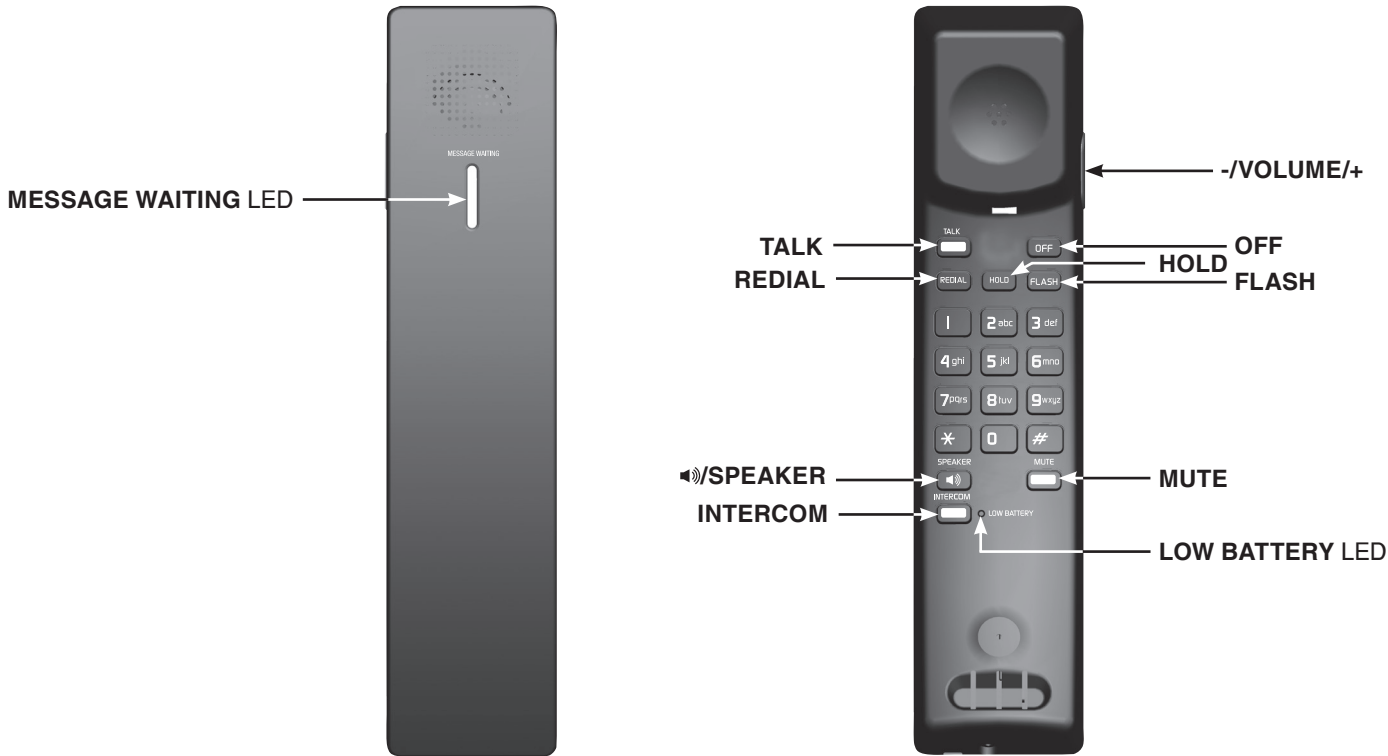



# Telephone layout

## Analog cordless 1-line accessory handset - CTM-C4101

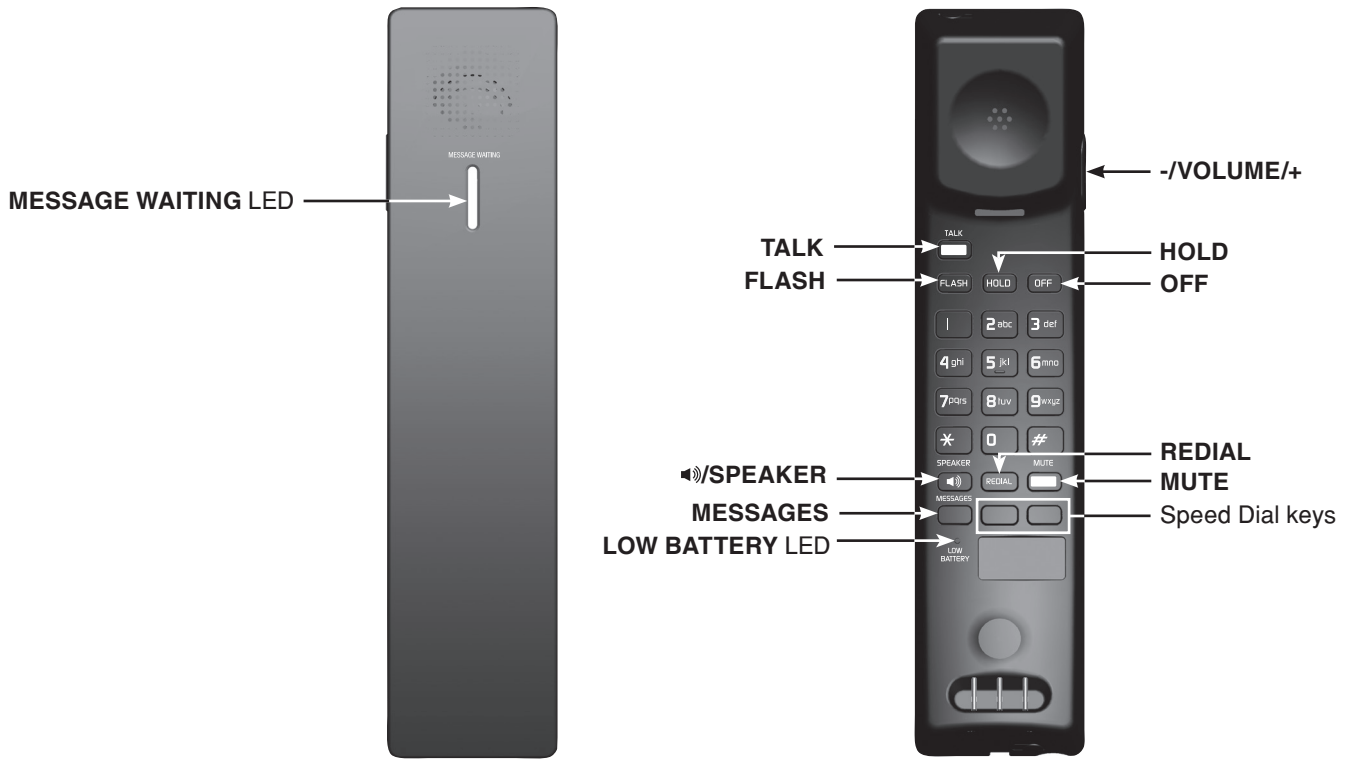

Telephone layout

# Telephone layout

## Analog cordless 1-line accessory handset and charger bundle - CTM-A241HS

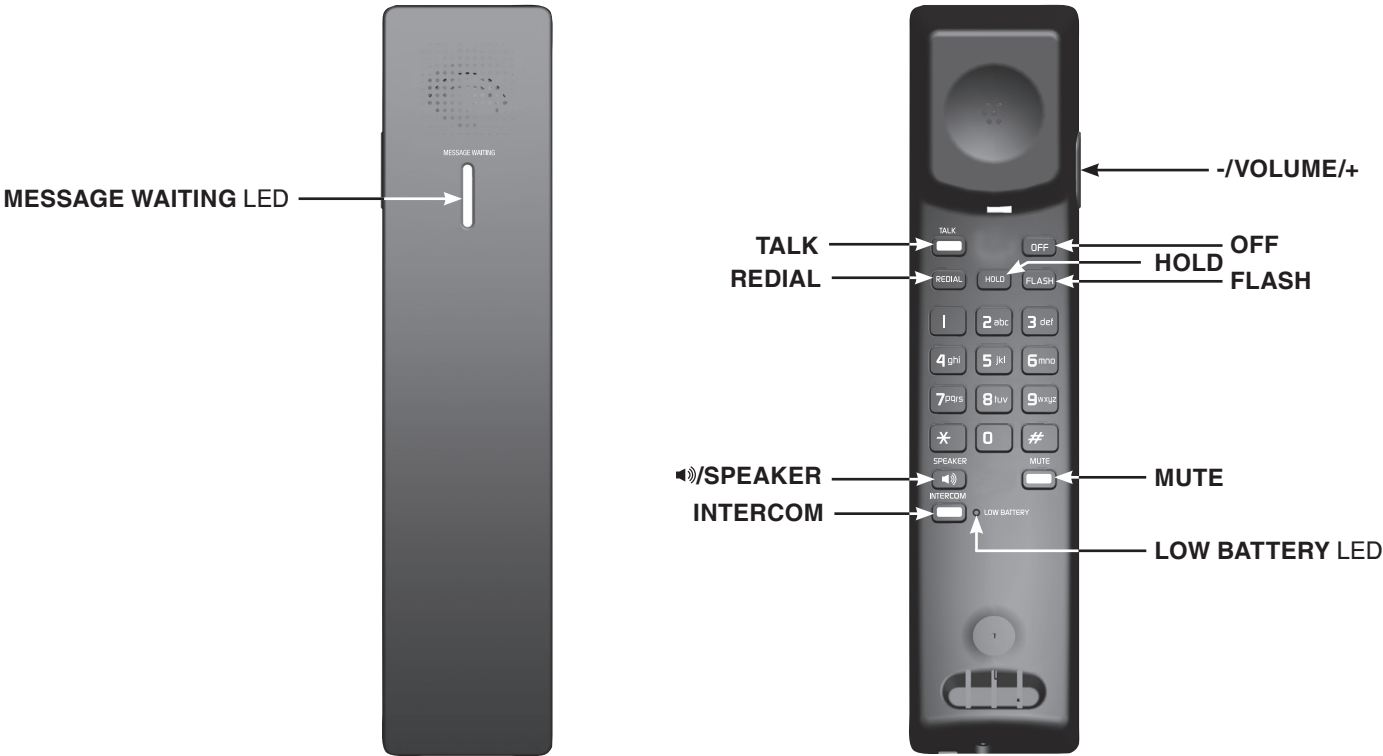

# Telephone layout

Analog cordless 1-line accessory handset with speed dials and charger bundle - CTM-A241SD

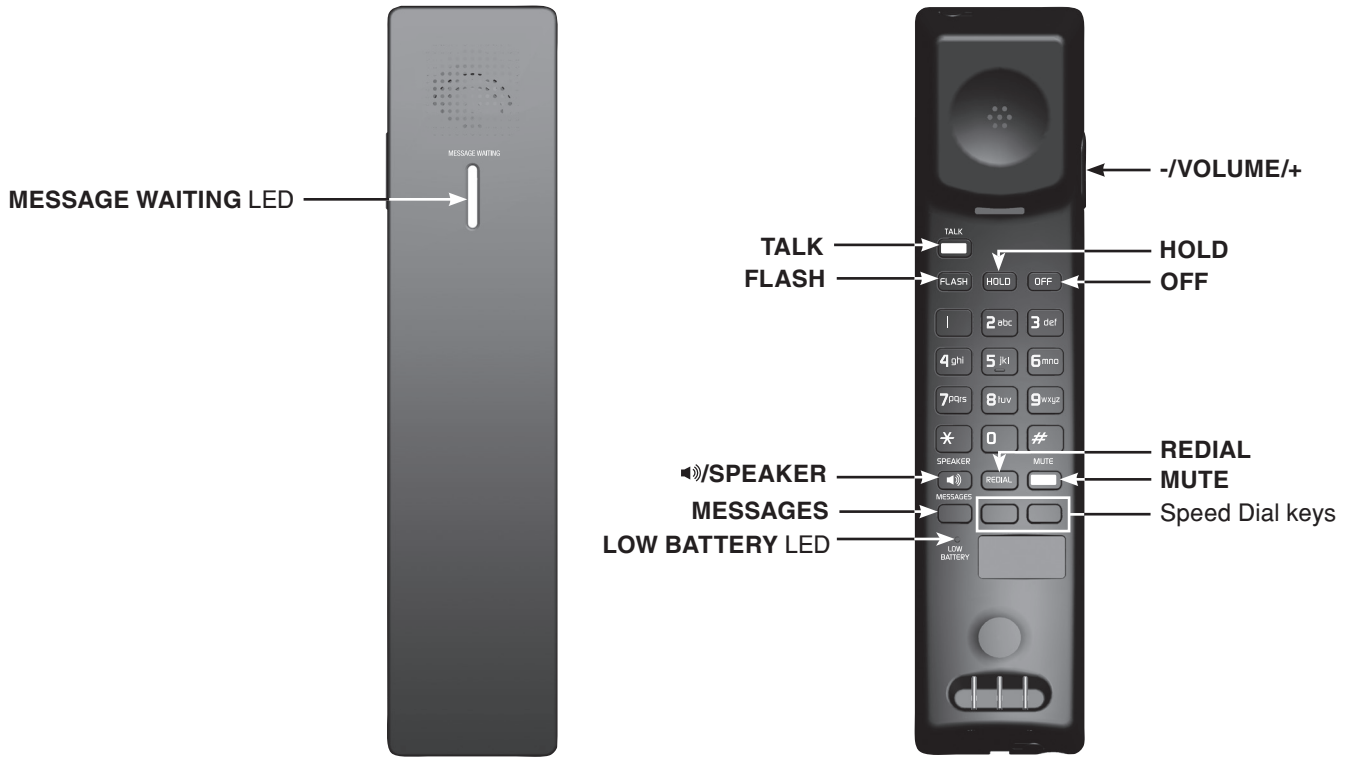

Telephone layout



# Telephone layout

## Analog cordless 2-line accessory handset - C4200

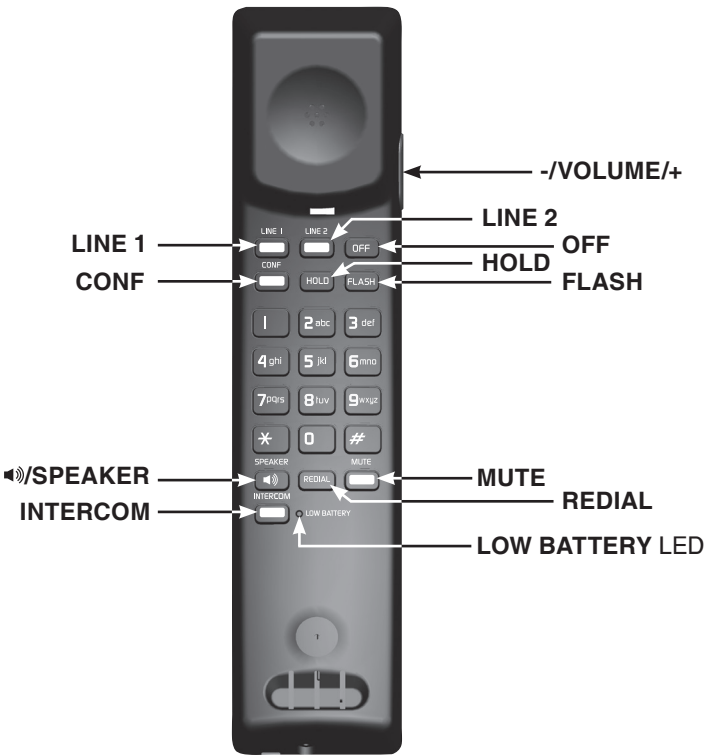
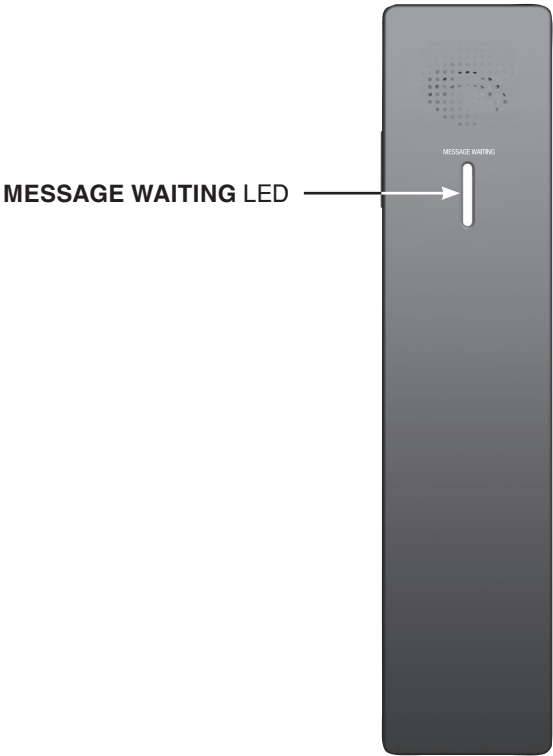

# Telephone layout

## Analog cordless 2-line accessory handset - CTM-C4201

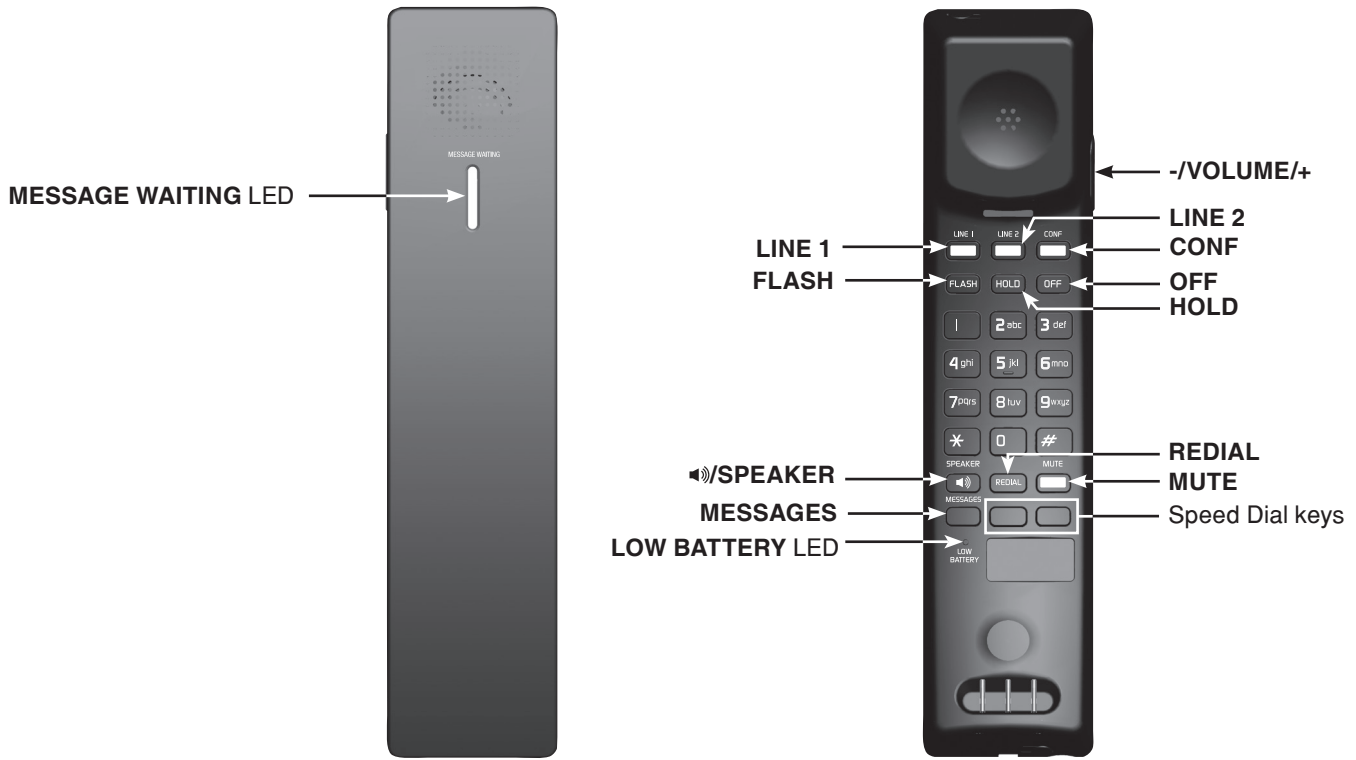

Telephone layout

# Telephone layout

## Analog cordless 2-line accessory handset and charger bundle - CTM-A242HS

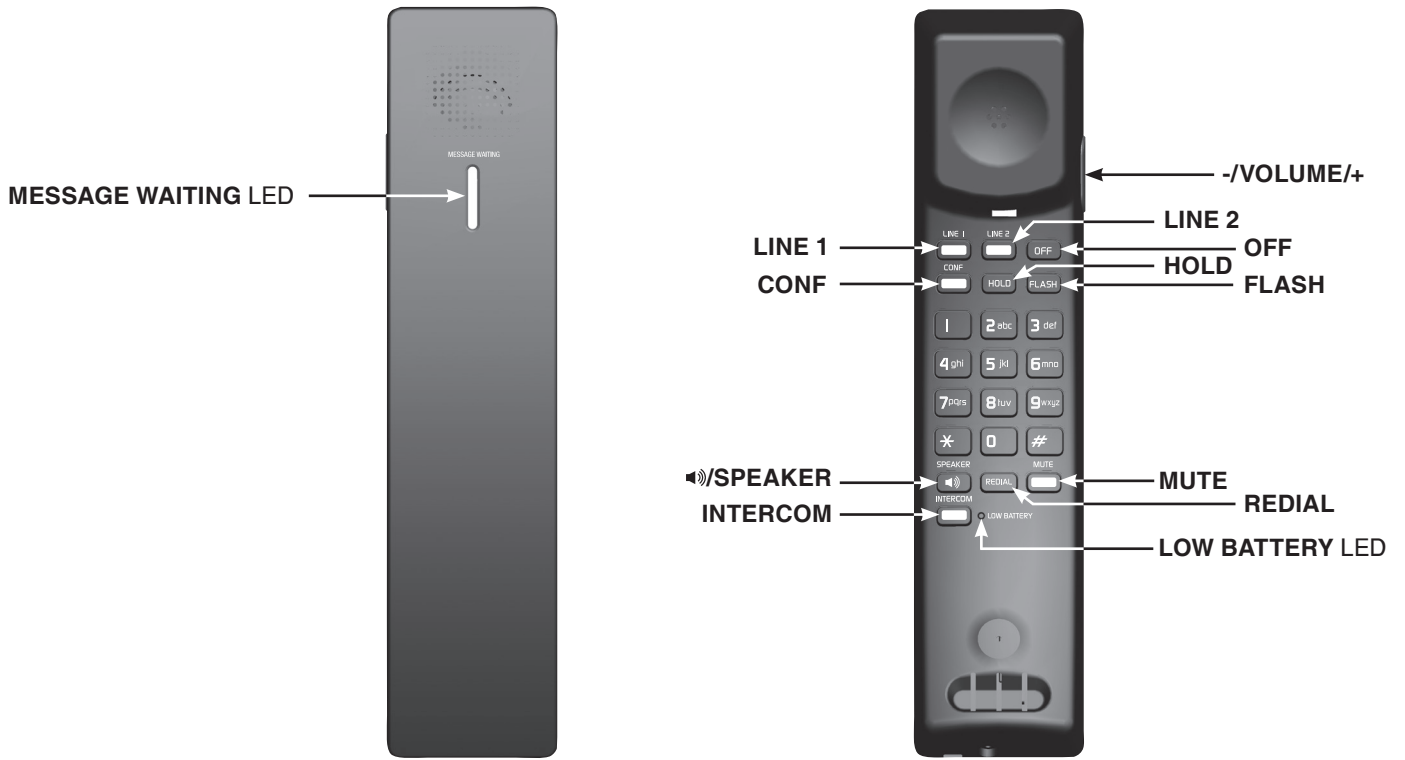

CHARGE LED

# Telephone layout

Analog cordless 2-line accessory handset with speed dials and charger bundle - CTM-A242SD

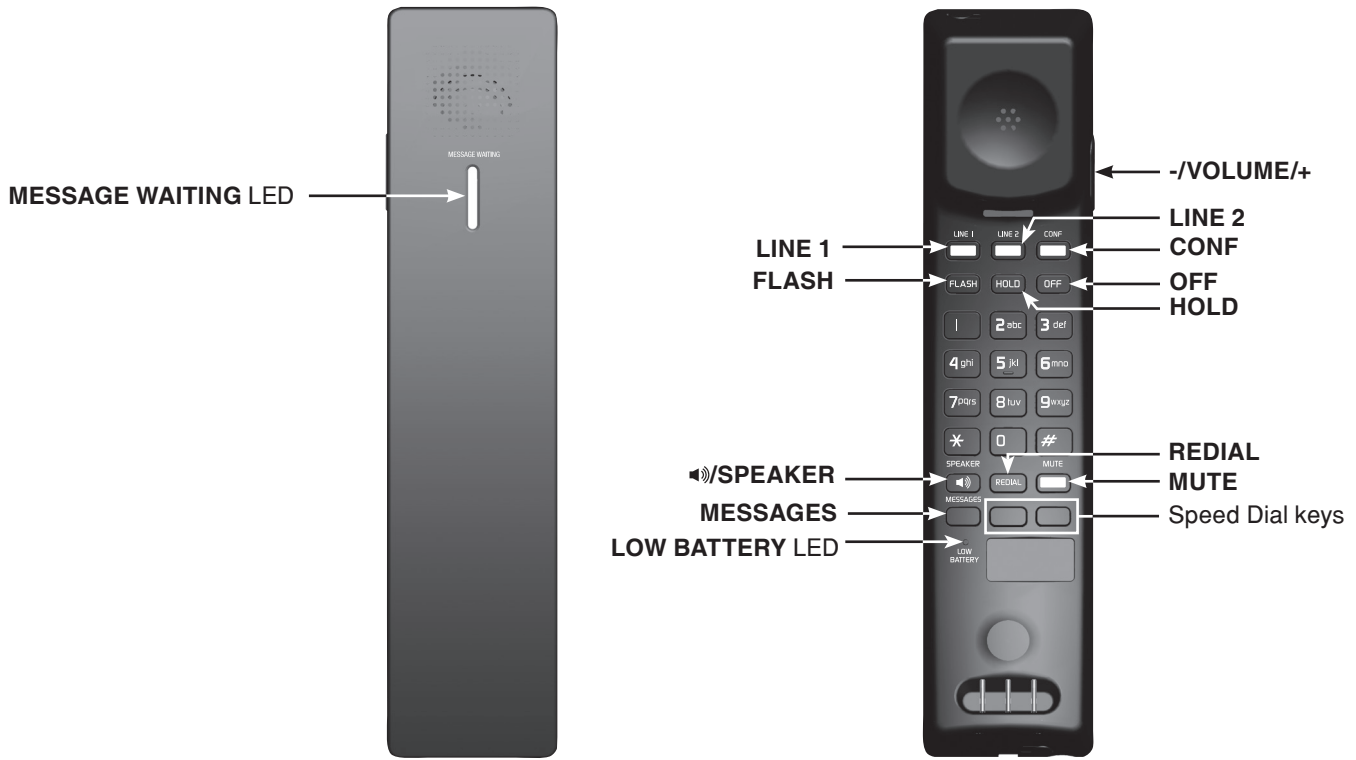

Telephone layout



# Installation

## Analog corded lobby/1-line/2-line - A2100/A2210/A2220

### Telephone base installation

This telephone can be adapted to desktop use or mount on a standard telephone wall plate.

#### Installation option - desktop position

1. Turn the telephone base over with the bottom side facing up. Connect the coiled handset cord to the telephone base.

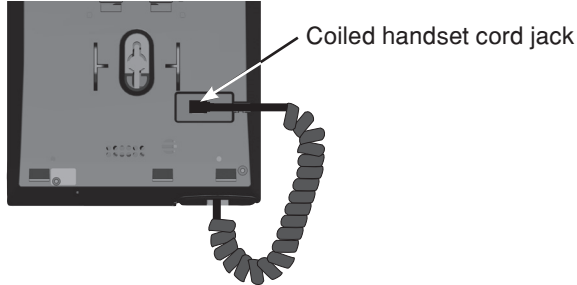

2. Insert the tabs into the grooves to affix the mounting bracket in place.

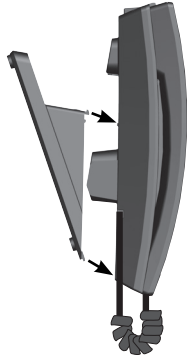

3. Install the telephone base as shown below.

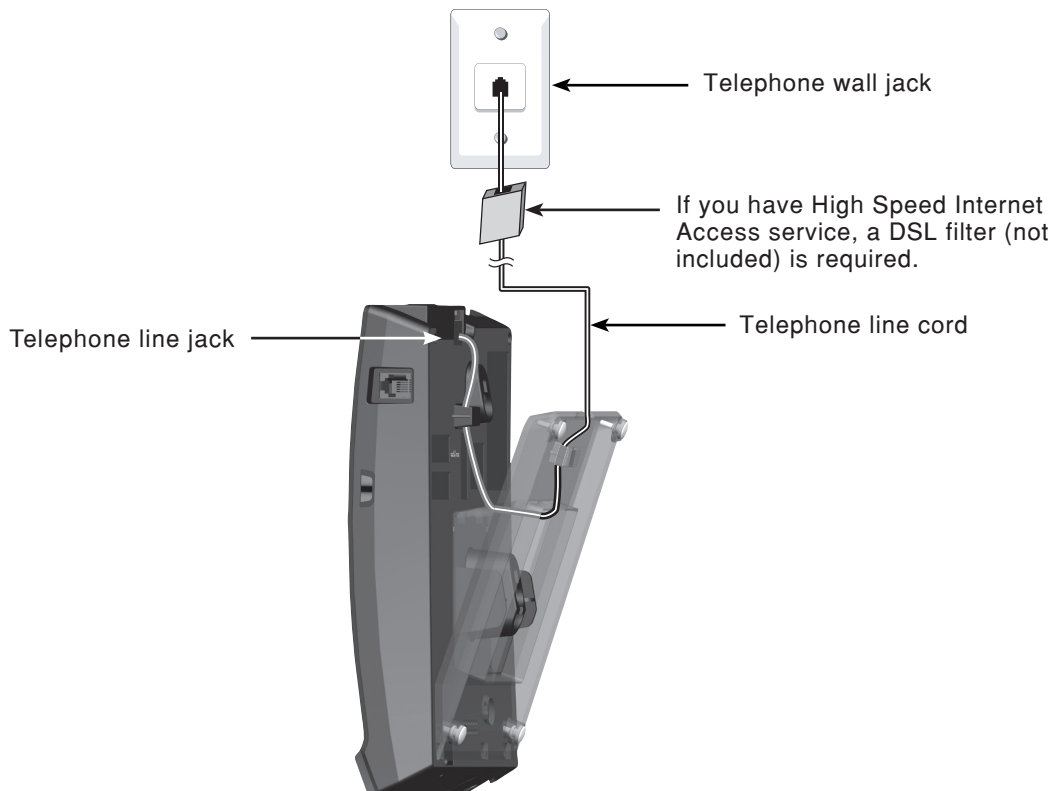



# Installation

## Analog corded lobby/1-line/2-line - A2100/A2210/A2220

### Installation option - converting from desktop to wall mount position

#### To mount the telephone base on the wall:

1. Set aside the handset. On the telephone base cradle, place a coin in the slit of the wall mount clip and rotate a half turn (180 degrees). It locks into place with the protruding edge pointing towards the upper edge of the telephone base. This protruding edge holds the handset when the phone is mounted on the wall.

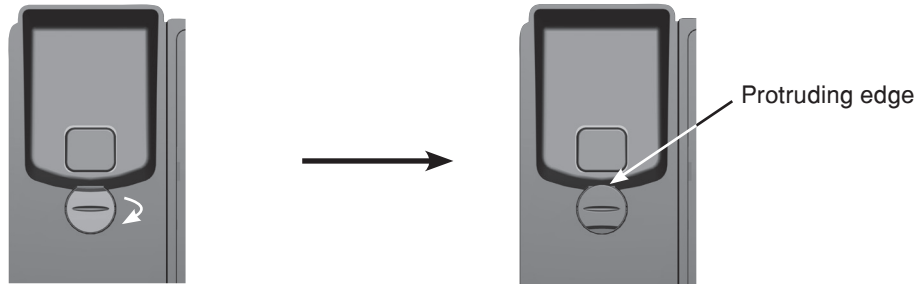

2. Turn the telephone base over with the bottom side facing up. To remove the mounting bracket, firmly push both tabs downward and pull up until both tabs release from the grooves.

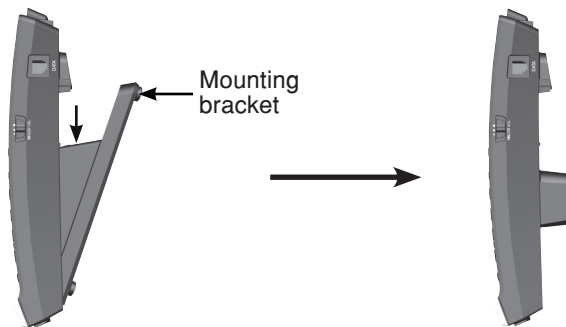

3. Mount the telephone base on the wall by aligning the eyelets with the mounting studs of the wall plate. Then slide the telephone base down on both mounting studs until it locks into place.

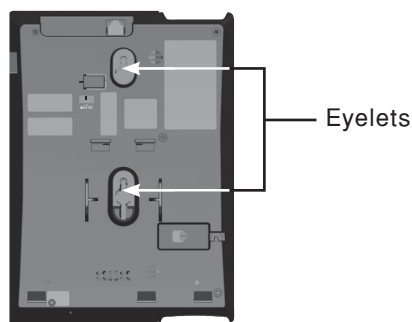

4. Place the handset on the telephone base cradle.

# Installation

## Analog corded trimstyle - A2310

### Telephone base installation

The telephone can be adapted to desktop use or mount on a standard telephone wall plate.

### Installation option - desktop position

1. Turn the telephone base over with the bottom side facing up. Connect the telephone line cord to the telephone base and route along the wire duct.

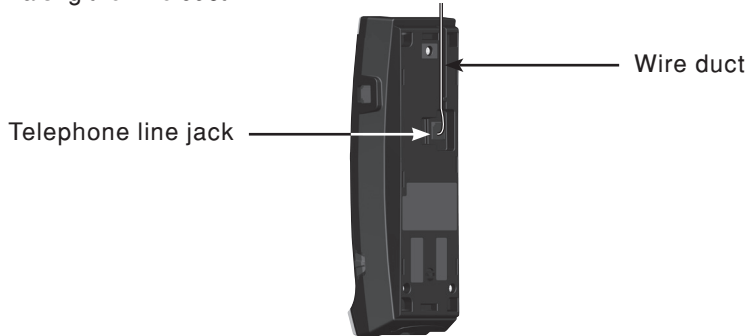

2. Position the mounting bracket as shown. Insert the two small tabs of the mounting bracket into the lower slots on the telephone base. Then press the large tab on the mounting bracket and firmly push it into the upper groove on the telephone base.

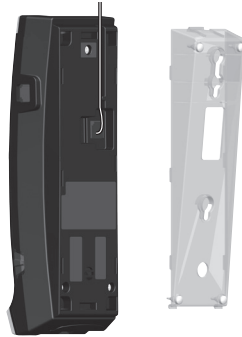

3. Install the telephone base as shown below. Then connect the coiled handset cord to the telephone base.

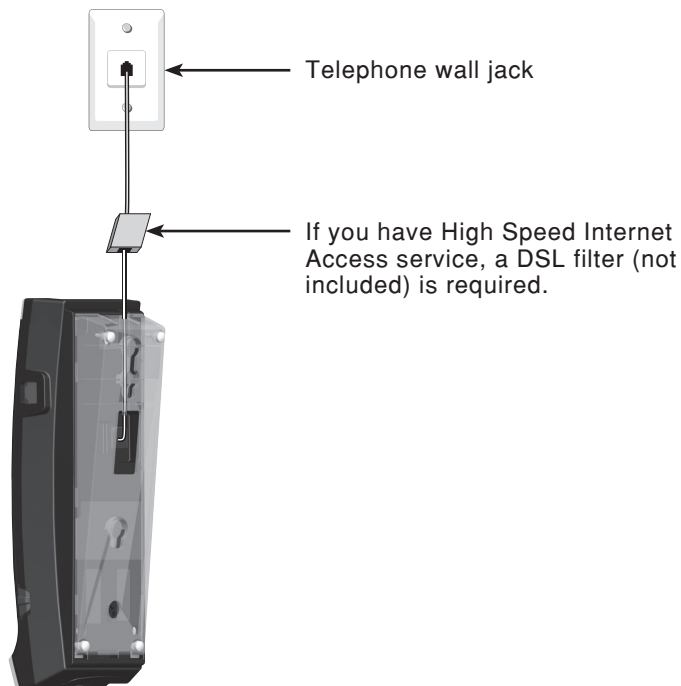

# Installation

## Analog corded trimstyle - A2310

### Installation option - converting from desktop to wall mount position

#### To mount the telephone base on the wall:

1. Set aside the handset. On the telephone base cradle, place a coin in the slit of the wall mount clip and rotate a half turn (180 degrees). It locks into place with the protruding edge pointing towards the upper edge of the charging base. This protruding edge holds the cordless handset when the phone is mounted on the wall.

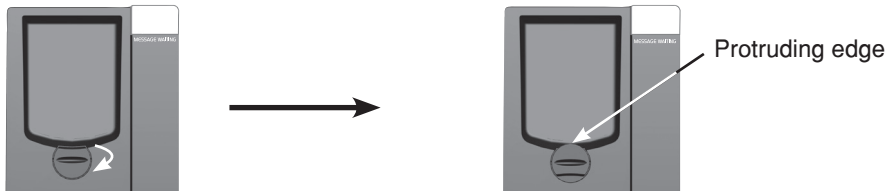

2. Unplug the telephone line cord from the telephone wall jack. Then press the large tab on the mounting bracket to remove it from the upper groove on the telephone base.

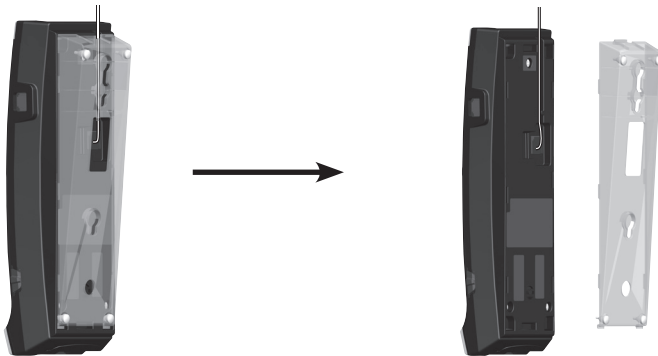

3. Turn the mounting bracket upside down. Remove the telephone line cord from the wire duct and then route it through the rectangular hole on the mounting bracket. Insert the small tabs on the mounting bracket into the upper slots on the telephone base. Then press the large tab on the mounting bracket and firmly push it into the lower groove on the telephone base.

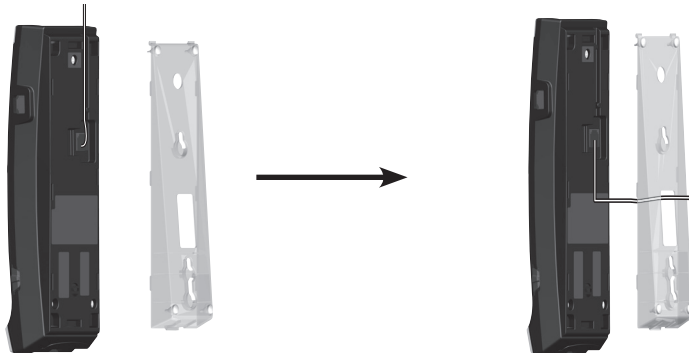

4. Mount the telephone base on the wall by aligning the eyelets with the mounting studs of the wall plate. Then slide the telephone base down on both mounting studs until it locks into place. Place the handset on the telephone base cradle.

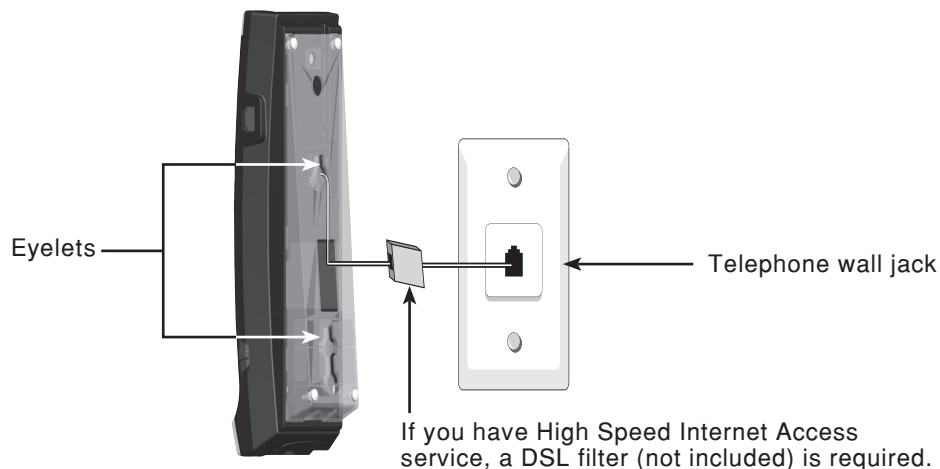

# Installation

## Analog cordless 1-line/2-line - A2410/CTM-A2411/A2420/CTM-A2421

### Telephone base installation

This telephone can be adapted to desktop use or mount on a standard telephone wall plate.

#### Installation option - desktop position

1. Turn the telephone base over with the bottom side facing up. Insert the tabs into the grooves to affix the mounting bracket in place.



2. Plug the power adapter into an electrical outlet not controlled by a wall switch.

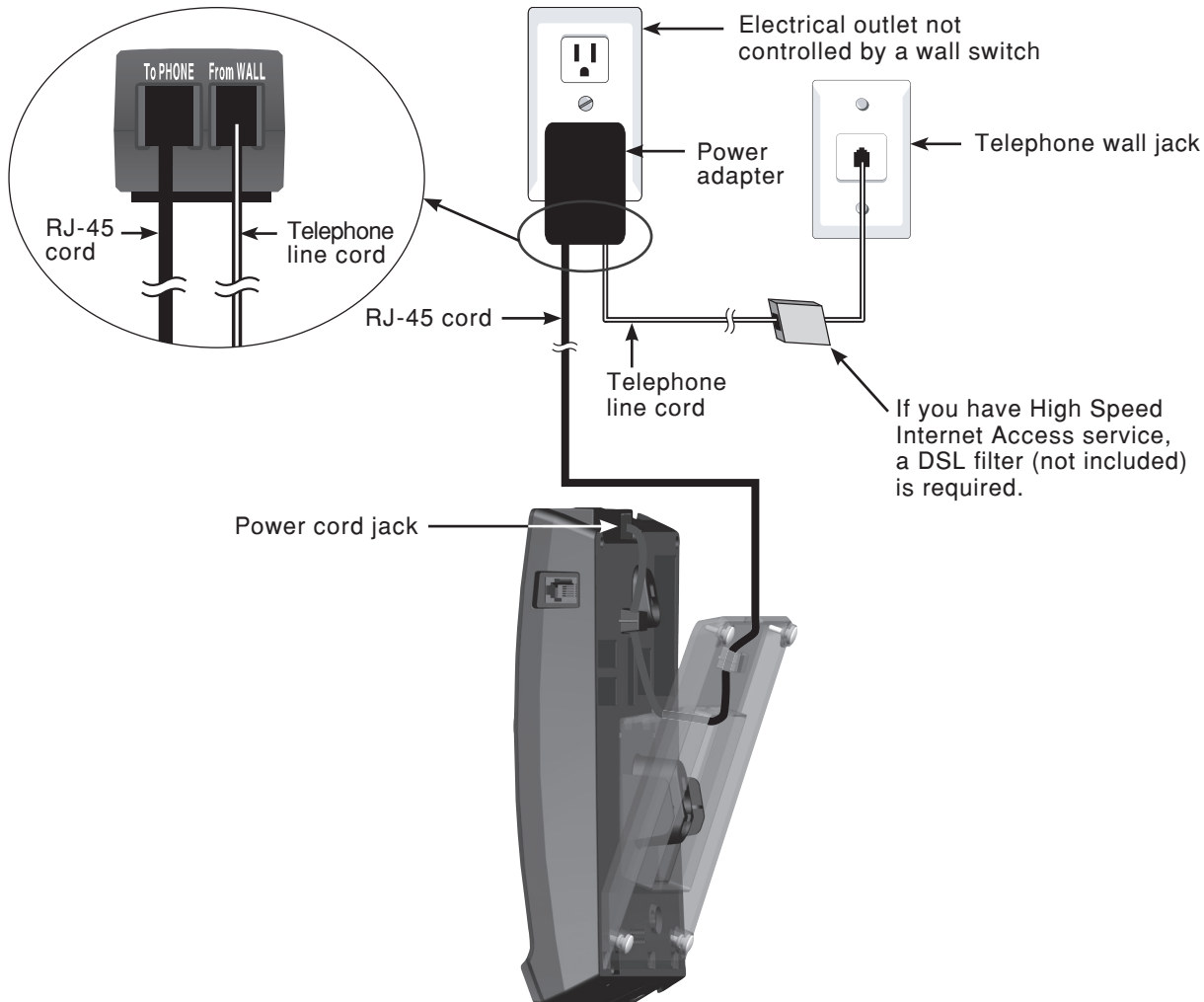

3. When the telephone base has been initially installed, press **SPEAKER** on the telephone base. Listen for a dial tone and then press **SPEAKER** again to hang up.

#### CAUTION:

Use only the supplied RJ-45 cord and power adapter. RJ-45 cord is not designed for use in any other IT devices. Misuse of RJ-45 cord on your other IT devices shall be prohibited. To order a replacement, visit our website at [www.vtechhotelphones.com](http://www.vtechhotelphones.com) or contact your local distributor.

# Installation

## Analog cordless 1-line/2-line - A2410/CTM-A2411/A2420/CTM-A2421

### Installation option - converting from desktop to wall mount position

#### To mount the telephone base on the wall:

1. Unplug the power adapter and telephone line cord. Disconnect the power cord from the telephone base.
2. Set aside the handset. On the telephone base cradle, place a coin in the slit of the wall mount clip and rotate a half turn (180 degrees). It locks into place with the protruding edge pointing towards the upper edge of the telephone base. This protruding edge holds the handset when the phone is mounted on the wall.

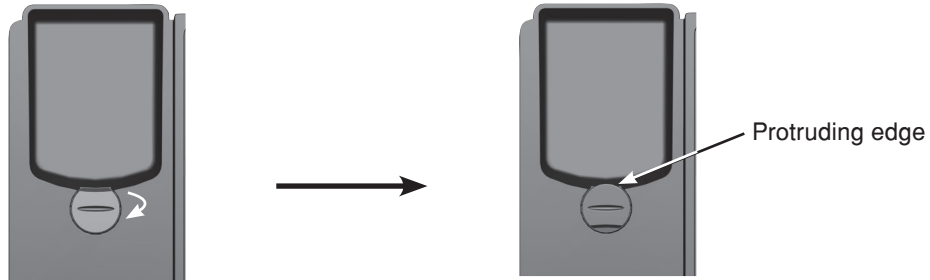

3. Turn the telephone base over with the bottom side facing up. To remove the mounting bracket, firmly push both tabs downward and pull up until both tabs release from the grooves.

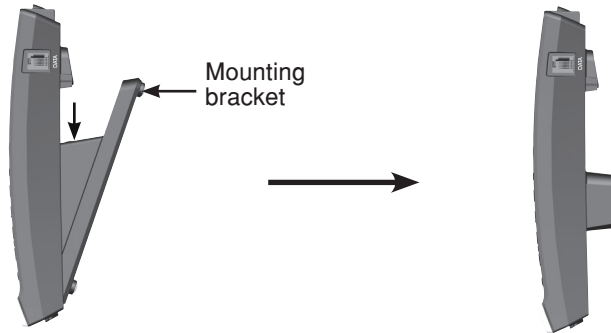

4. Mount the telephone base on the wall by aligning the eyelets with the mounting studs of the wall plate. Then slide the telephone base down on both mounting studs until it locks into place.

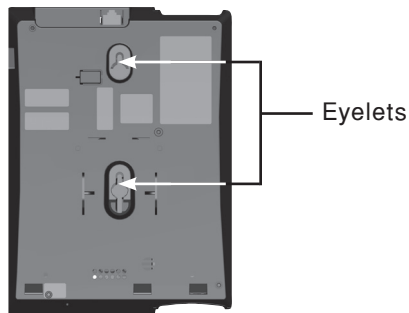

5. Connect the power cord to the telephone base. Plug the power adapter into an electrical outlet not controlled by a wall switch, and plug the telephone line cord into the telephone wall jack. Then place the cordless handset on the telephone base cradle.

## Installation

### Analog cordless 1-line/2-line - CTM-A2411-BATT/CTM-A2421-BATT

#### Telephone base backup battery installation

You can install a backup battery in the telephone base to guarantee continual operation during a power outage. The telephone base backup battery only supports complete operation for the telephone base and handset on line 1 during a power outage. You can buy rechargeable battery (BT264392/BT266342) for the telephone base. When the battery is installed and AC power is connected, the battery will be recharged.

You should replace the installed battery when the LED next to the battery compartment flashes.

Install the battery as shown below.

1. Insert a 5 mm standard screwdriver in the provided slot and then twist and lift to remove the battery compartment cover.
2. Plug the battery connector securely into the socket inside the battery compartment.
3. Place the battery with the label **THIS SIDE UP** facing up and the wires inside the battery compartment.
4. To replace the cover, align all the tabs on the telephone base battery cover against the corresponding grooves on the telephone base, then firmly push downward until all the tabs lock in the grooves. Install the screw at the bottom of the handset.

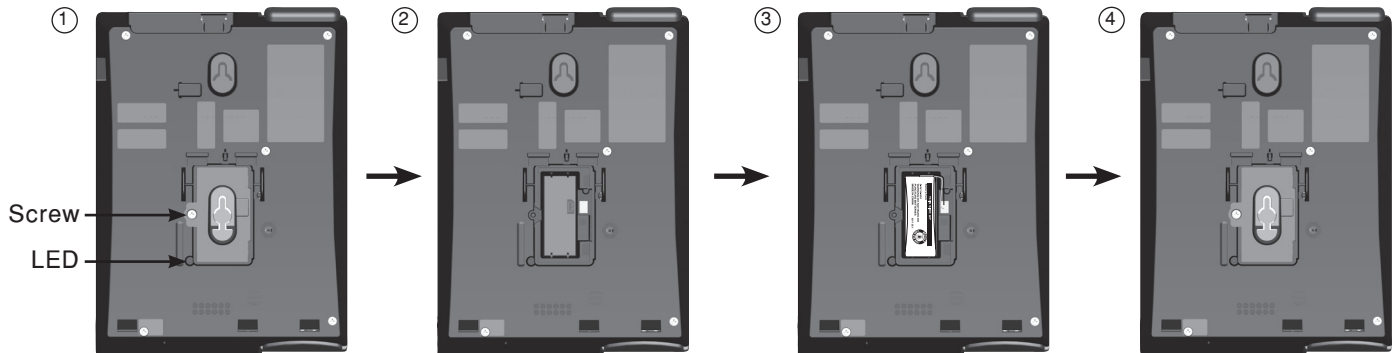

#### Replace a telephone base backup battery

1. Insert a 5 mm standard screwdriver in the provided slot and then twist and lift to remove the battery compartment cover.
2. Unplug the battery connector from the socket and then remove the battery from the battery compartment.
3. Follow Step 2 to Step 4 in **Telephone base backup battery installation** above to install a new battery.

#### CAUTIONS:

- There may be a risk of explosion if a wrong type of battery is used. Use only rechargeable battery (BT264392/BT266342). To order a battery, visit our website at [www.vtechhotelphones.com](http://www.vtechhotelphones.com) or contact your local distributor.
- Dispose of used batteries according to the information in **Product disposal instructions** on page 86.

# Installation

## Analog cordless 1-line/2-line - CTM-A2411-BATT/CTM-A2421-BATT

### Telephone base installation

This telephone can be adapted to desktop use or mount on a standard telephone wall plate.

### Installation option - desktop position

1. Turn the telephone base over with the bottom side facing up. Insert the tabs into the grooves to affix the mounting bracket in place.

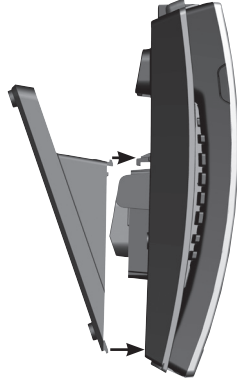

2. Plug the power adapter into an electrical outlet not controlled by a wall switch.

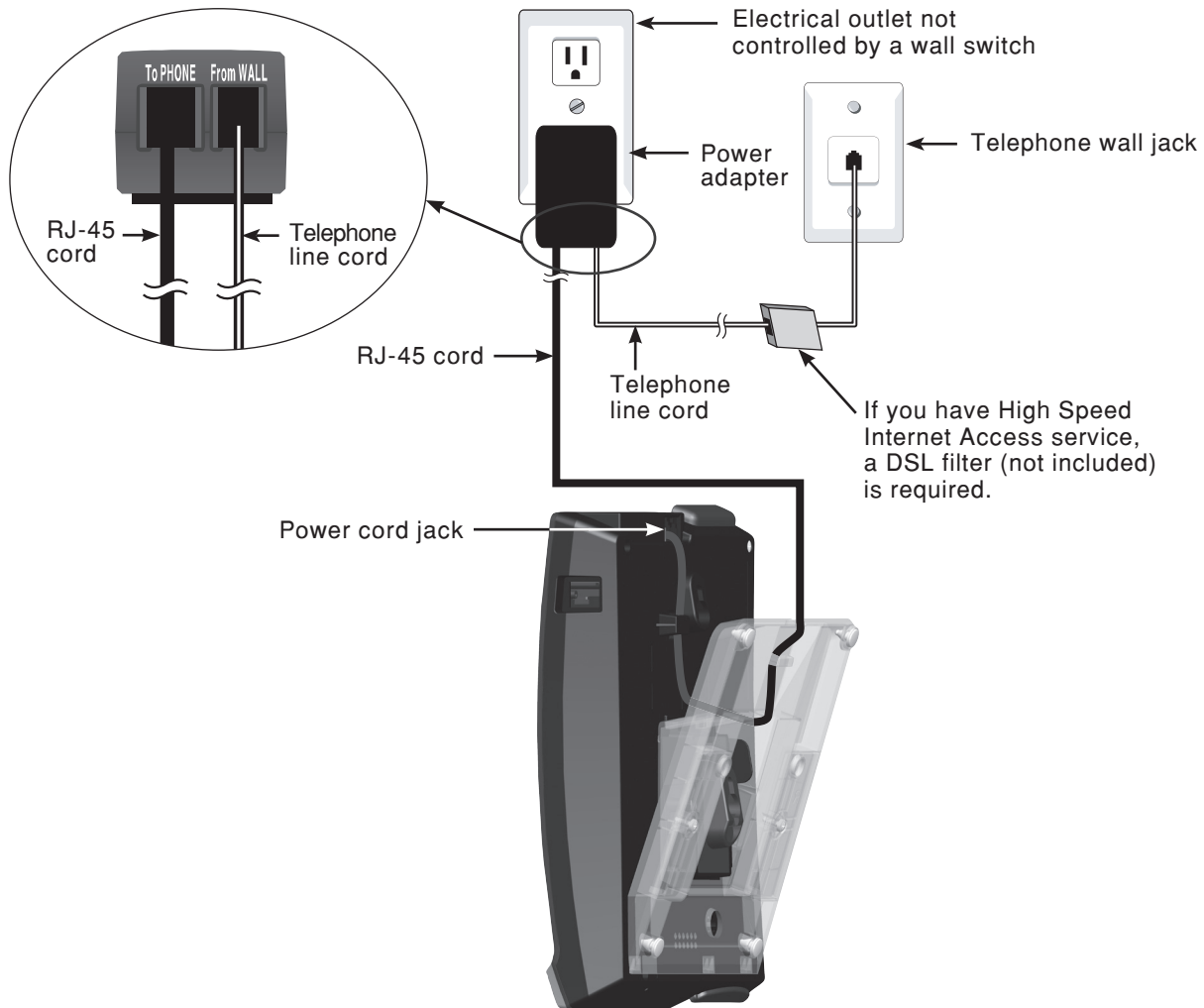

3. When the telephone base has been initially installed, press **SPEAKER** on the telephone base. Listen for a dial tone and then press **SPEAKER** again to hang up.

### CAUTION:

Use only the supplied RJ-45 cord and power adapter. RJ-45 cord is not designed for use in any other IT devices. Misuse of RJ-45 cord on your other IT devices shall be prohibited. To order a replacement, visit our website at [www.vtechhotelphones.com](http://www.vtechhotelphones.com) or contact your local distributor.

Installation

## Installation

### Analog cordless 1-line/2-line - CTM-A2411-BATT/CTM-A2421-BATT

#### Installation option - converting from desktop to wall mount position

##### To mount the telephone base on the wall:

1. Unplug the power adapter and telephone line cord. Disconnect the power cord from the telephone base.
2. Set aside the handset. On the telephone base cradle, place a coin in the slit of the wall mount clip and rotate a half turn (180 degrees). It locks into place with the protruding edge pointing towards the upper edge of the telephone base. This protruding edge holds the handset when the phone is mounted on the wall.

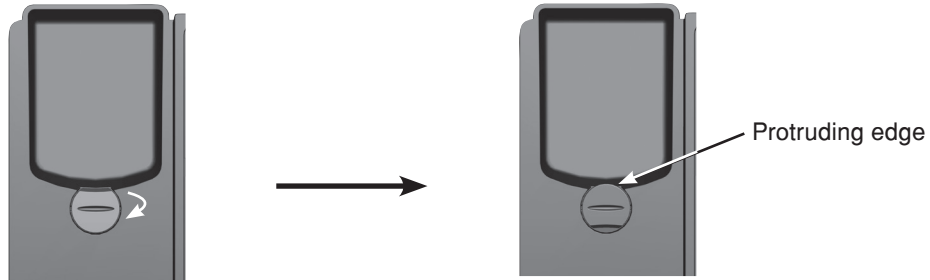

3. Turn the telephone base over with the bottom side facing up. To remove the mounting bracket, firmly push both tabs downward and pull up until both tabs release from the grooves.

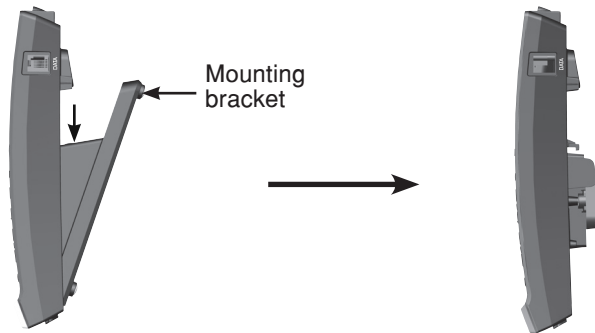

4. Mount the telephone base on the wall by aligning the eyelets with the mounting studs of the wall plate. Then slide the telephone base down on both mounting studs until it locks into place.

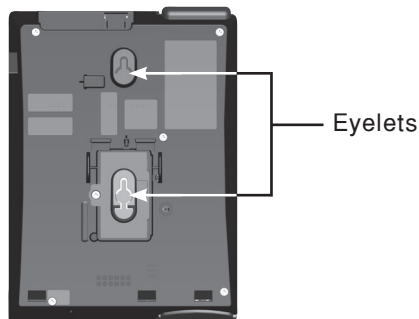

5. Connect the power cord to the telephone base. Plug the power adapter into an electrical outlet not controlled by a wall switch, and plug the telephone line cord into the telephone wall jack. Then place the cordless handset on the telephone base cradle.



# Installation

## Analog cordless 1-line/2-line - A2410/A2420

### Handset battery installation

Install the battery as shown below.

1. Gently lift the handset cover. Do not detach the speaker wires between the handset cover and the handset.
2. Plug the battery connector securely into the socket inside the handset battery compartment.
3. Place the battery with the label **THIS SIDE UP** facing up and the wires inside the battery compartment.
4. To replace the handset cover, align all the tabs on the handset cover against the corresponding grooves on the handset, then firmly push downward until all the tabs lock in the grooves. Then install the screw at the bottom of the handset.

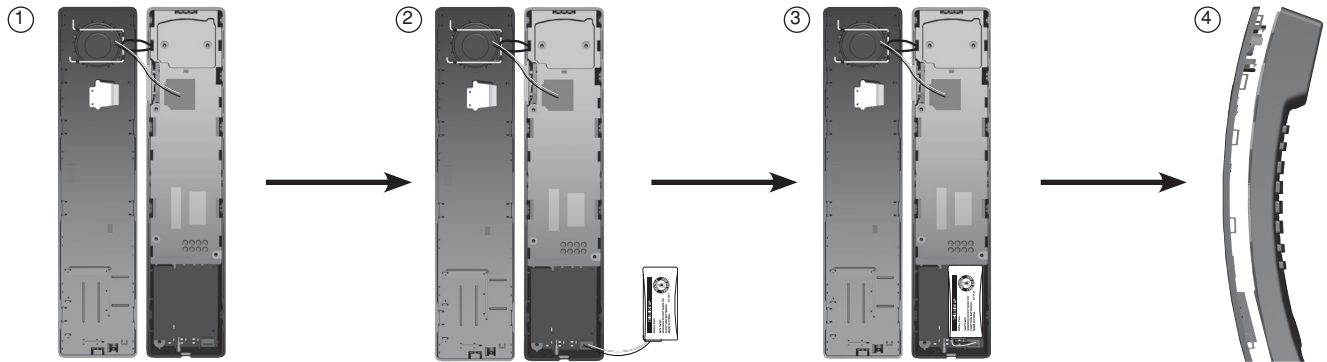

### Replace a handset battery

1. Use a 5 mm standard screwdriver to open the screw cover and remove the screw. Insert the screwdriver in the provided slot and then twist and lift to open the bottom part.

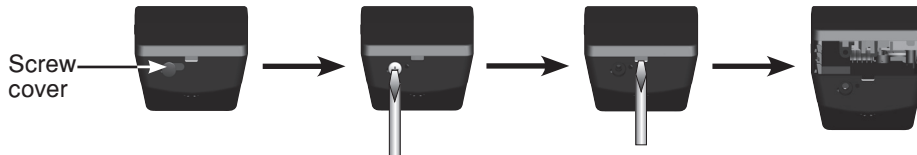

2. Use your thumb to slide along the sides of the handset carefully to release the tabs on the handset cover from the slots on the sides of the handset. Then gently detach the handset cover from the handset.



Do not detach the speaker wires between the handset cover and the handset.

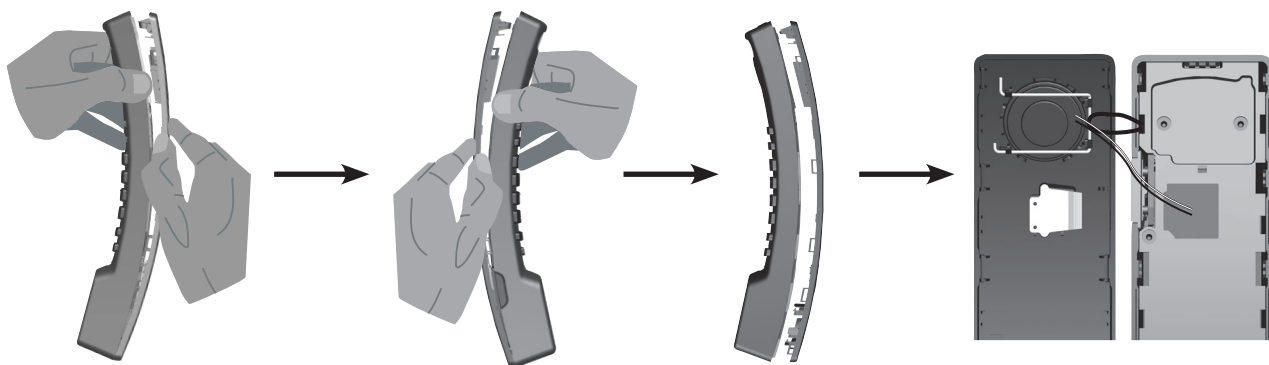

3. Unplug the battery connector from the socket and then remove the battery from the handset battery compartment.
4. Follow Step 2 to Step 4 in **Handset battery installation** above to install a new battery.

### CAUTIONS:

- There may be a risk of explosion if a wrong type of handset battery is used. Use only the supplied rechargeable battery (BT264392/BT266342) or replacement battery (BT266342). To order a replacement, visit our website at [www.vtechhotelphones.com](http://www.vtechhotelphones.com) or contact your local distributor.
- Dispose of used batteries according to the information in **Product disposal instructions** on page 86.

# Installation

## Analog cordless 1-line/2-line - A2410/A2420

### Handset registration

Place the cordless handset on the telephone base cradle. Handset registration happens automatically the first time a cordless handset is placed on the telephone base. When the registration process completes, the **MESSAGE WAITING** LED flashes once and you hear 3 rising beeps as confirmation. Each telephone base accommodates up to 4 cordless handsets. When the telephone base has already registered 4 cordless handsets, one of the registered cordless handsets must be deregistered or registered to another telephone base before adding a new cordless handset.

### Handset deregistration

When a registered cordless handset is idle, press **\*331734#** and then press **HOLD**. You hear 3 rising beeps as confirmation when the deregistration process completes.

### Register a handset to another telephone base

Any **A2410** handset can register to any **A2410** telephone base. Any **A2420** handset can register to any **A2420** telephone base.

When a registered cordless handset is idle, place it on another telephone base. This cordless handset automatically registers to the new telephone base.

### Handset battery charging

The battery must be fully charged before using the cordless handset for the first time. The **CHARGE** LED turns on when the cordless handset is charging on the telephone base, charging base or charging stand. The battery is fully charged after 16 hours of continuous charging. For best performance, keep the cordless handset in the telephone base, charging base or charging stand when not in use.

# Installation

## Analog cordless 1-line/2-line - CTM-A2411/CTM-A2411-BATT/CTM-A2421/CTM-A2421-BATT

### Handset battery installation

Install the battery as shown below.

1. Plug the battery connector securely into the socket inside the handset battery compartment.
2. Place the battery with the label **THIS SIDE UP** facing up and the wires inside the battery compartment.
3. To replace the handset cover, align all the tabs on the handset cover against the corresponding grooves on the handset, then firmly push downward until all the tabs lock in the grooves. Then install the screws at both ends of the handset.

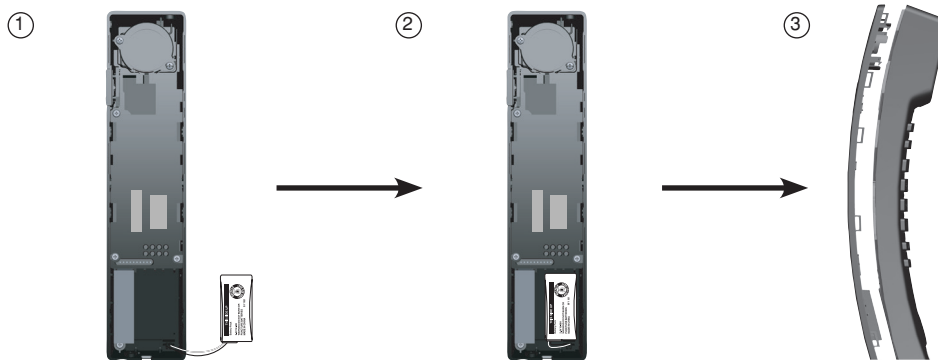

### Replace a handset battery

1. Use a 5 mm standard screwdriver to open the screw cover and remove the screw.
2. Insert the screwdriver in the provided slot and then twist and lift to open the bottom part.

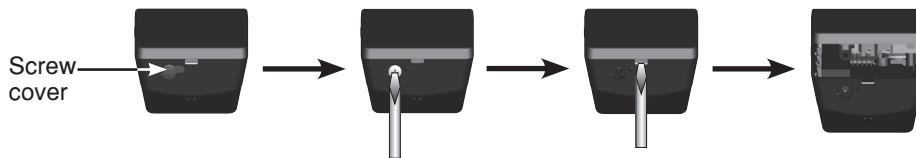

**-OR-**

Open the bottom part manually at the recessed area to avoid scratching the plastic.

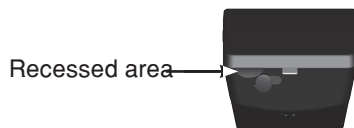

3. Use your thumb to slide along the sides of the handset carefully to release the tabs on the handset cover from the slots on the sides of the handset. Then gently detach the handset cover from the handset.

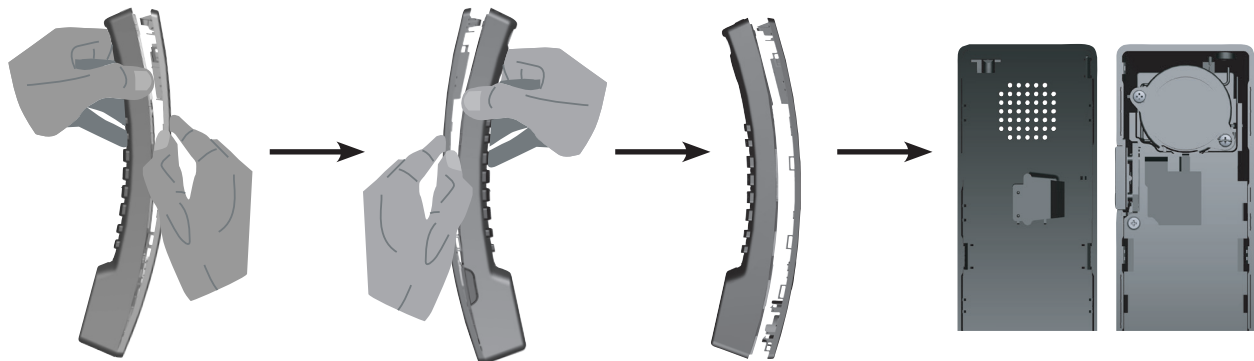

4. Unplug the battery connector from the socket and then remove the battery from the handset battery compartment.
5. Follow Step 2 to Step 4 in **Handset battery installation** above to install a new battery.

### CAUTIONS:

- There may be a risk of explosion if a wrong type of handset battery is used. Use only the supplied rechargeable battery (BT264392/BT266342) or replacement battery (BT266342). To order a replacement, visit our website at [www.vtechhotelphones.com](http://www.vtechhotelphones.com) or contact your local distributor.
- Dispose of used batteries according to the information in **Product disposal instructions** on page 86.

## Installation

### Analog cordless 1-line/2-line - CTM-A2411/CTM-A2411-BATT/CTM-A2421/CTM-A2421-BATT

#### Handset registration

##### To register a cordless handset to the telephone base:

Place the cordless handset on the telephone base cradle. Handset registration happens automatically the first time a cordless handset is placed on the telephone base. When the registration process completes, the **MESSAGE WAITING** LED flashes once and you hear 3 rising beeps as confirmation. Each telephone base accommodates up to 4 cordless handsets or accessory Petite phones. When the telephone base has already registered 4 cordless handsets or accessory Petite phones, one of the registered cordless handsets or accessory Petite phones must be deregistered or registered to another telephone base before adding a new cordless handset or accessory Petite phone.

##### To register a cordless handset to the telephone base without placing it on the telephone base:

When the telephone base is idle, press **123** on the telephone base and then press **HOLD**. The **MESSAGE WAITING** LED on the base turns on for about 90 seconds. Press **123** on the cordless handset and then press **HOLD**. The **MESSAGE WAITING** LED on the handset turns on for 90 seconds. When the registration process completes, you hear 3 rising beeps as confirmation. When the telephone base has already registered 4 cordless handsets or accessory Petite phones, one of the registered cordless handsets or accessory Petite phones must be deregistered or registered to another telephone base before adding a new cordless handset or accessory Petite phone.

#### Handset deregistration

When a registered cordless handset is idle, press **\*331734#** and then press **HOLD**. You hear 3 rising beeps as confirmation when the deregistration process completes.

#### Register a handset to another telephone base

Any **CTM-A2411/CTM-A2411-BATT** handset can register to any **A2410/CTM-A2411/CTM-A2411-BATT** telephone base. Any **CTM-A2421/CTM-A2421-BATT** handset can register to any **A2420/CTM-A2421/CTM-A2421-BATT** telephone base.

When a registered cordless handset is idle, place it on another telephone base. This cordless handset automatically registers to the new telephone base.

#### Handset battery charging

The battery must be fully charged before using the cordless handset for the first time. The **CHARGE** LED turns on when the cordless handset is charging on the telephone base, charging base or charging stand. The battery is fully charged after 16 hours of continuous charging. For best performance, keep the cordless handset in the telephone base, charging base or charging stand when not in use.

# Installation

## Analog cordless 1-line/2-line accessory Petite - CTM-A241P/CTM-A242P

### Accessory Petite installation

The telephone can be adapted to desktop use or mounted on a standard telephone wall plate.

#### Installation option - desktop position

1. Turn the phone base over with the bottom side facing up. Connect the small end of the power adapter cord on the top of the phone.

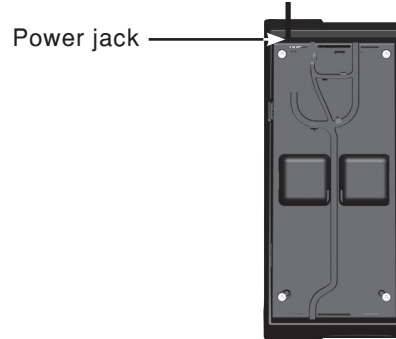

2. Position the mounting bracket as shown. Insert the two small tabs of the mounting bracket into the lower slots on the phone. Then press the large tab on the mounting bracket and firmly push it into the upper groove at the bottom.



3. Install the phone as shown below. Then connect the coiled handset cord at the side of the phone.

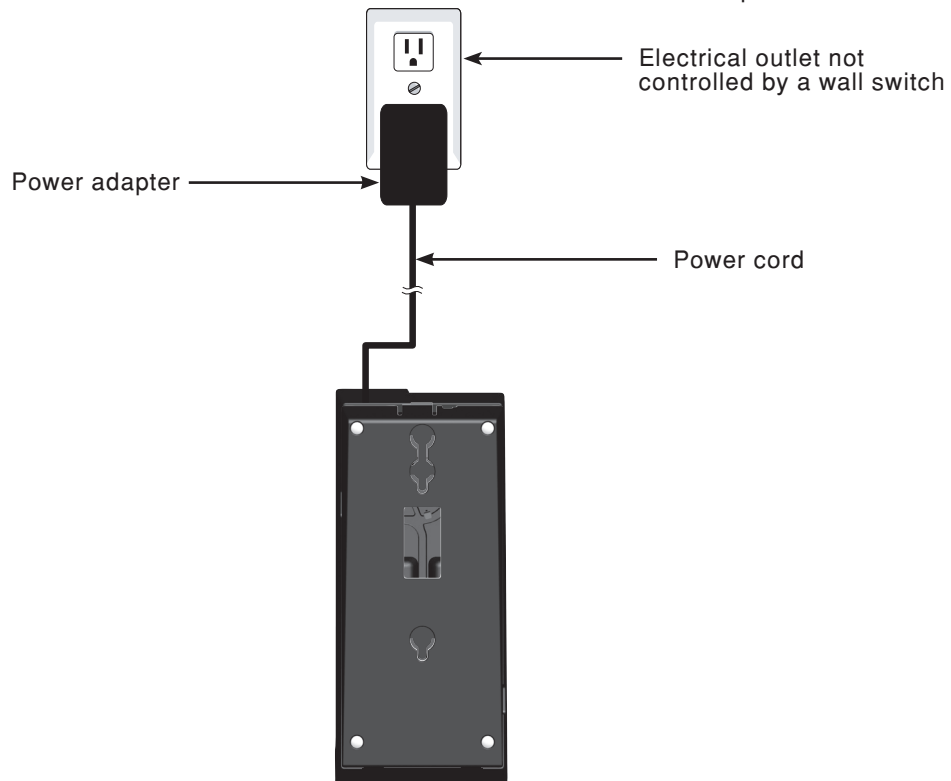

Installation

# Installation

## Analog cordless 1-line/2-line accessory Petite - CTM-A241P/CTM-A242P

### Installation option - converting from desktop to wall mount position

#### To mount the phone on the wall:

1. Set aside the handset. On the phone cradle, place a coin in the slit of the wall mount clip and rotate a half turn (180 degrees). It locks into place with the protruding edge pointing towards the upper edge of the phone. This protruding edge holds the corded handset when the phone is mounted on the wall.

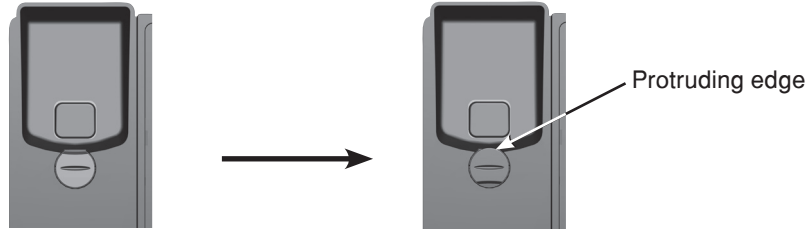

2. Press the large tab on the mounting bracket to remove it from the upper groove on the phone.

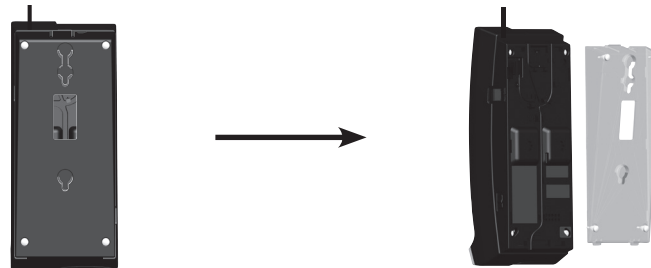

3. Turn the mounting bracket upside down. Insert the small tabs on the mounting bracket into the upper slots on the phone. Then press the large tab on the mounting bracket and firmly push it into the lower groove on the base.

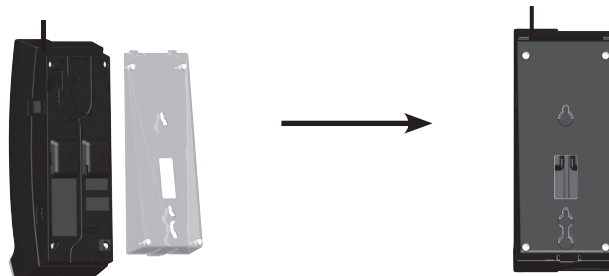

4. Mount the phone on the wall by aligning the eyelets with the mounting studs of the wall plate. Then slide the phone down on both mounting studs until it locks into place. Place the handset on the phone cradle.



# Installation

## Analog cordless 1-line/2-line accessory Petite - CTM-A241P/CTM-A242P

### Accessory Petite registration

To register an accessory Petite to a CTM-A2411/CTM-A2411-BATT/CTM-A2421/CTM-A2421-BATT/CTM-A2510/CTM-A2510-USB telephone base:

When the telephone base is idle, press **123** and then press **HOLD**. The **MESSAGE WAITING** LED turns on for about 90 seconds. Press **123** and then **HOLD** on the accessory Petite, the **MESSAGE WAITING** LED on the accessory Petite turns on for 90 seconds.

When the registration process completes, you hear 3 rising beeps as confirmation. When the telephone base has already registered 4 cordless handsets or accessory Petite phones, one of the registered cordless handsets or accessory Petite phones must be deregistered or registered to another telephone base before adding a new cordless handset or accessory Petite phone.

### Accessory Petite deregistration

When a registered accessory Petite is idle, press **\*331734#** and then press **HOLD**. You hear 3 rising beeps as confirmation when the deregistration process completes.

### Register an accessory Petite to another telephone base

Any analog cordless 1-line accessory Petite can register to any CTM-A2411/CTM-A2411-BATT/CTM-A2510/CTM-A2510-USB telephone base. Any analog cordless 2-line accessory Petite can register to any CTM-A2421/CTM-A2421-BATT telephone base.

# Installation

## Analog corded/cordless 1-line - CTM-A2510/CTM-A2510-USB

### Telephone base installation

This telephone can be adapted to desktop use or mount on a standard telephone wall plate.

#### Installation option - desktop position

1. Turn the telephone base over with the bottom side facing up. Connect the coiled handset cord to the telephone base.

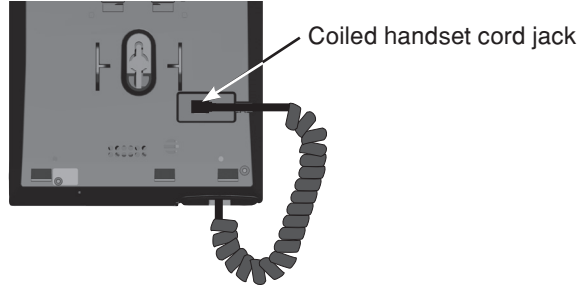

2. Insert the tabs into the grooves to affix the mounting bracket in place.

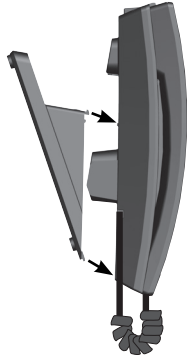

3. Install the telephone base as shown below.

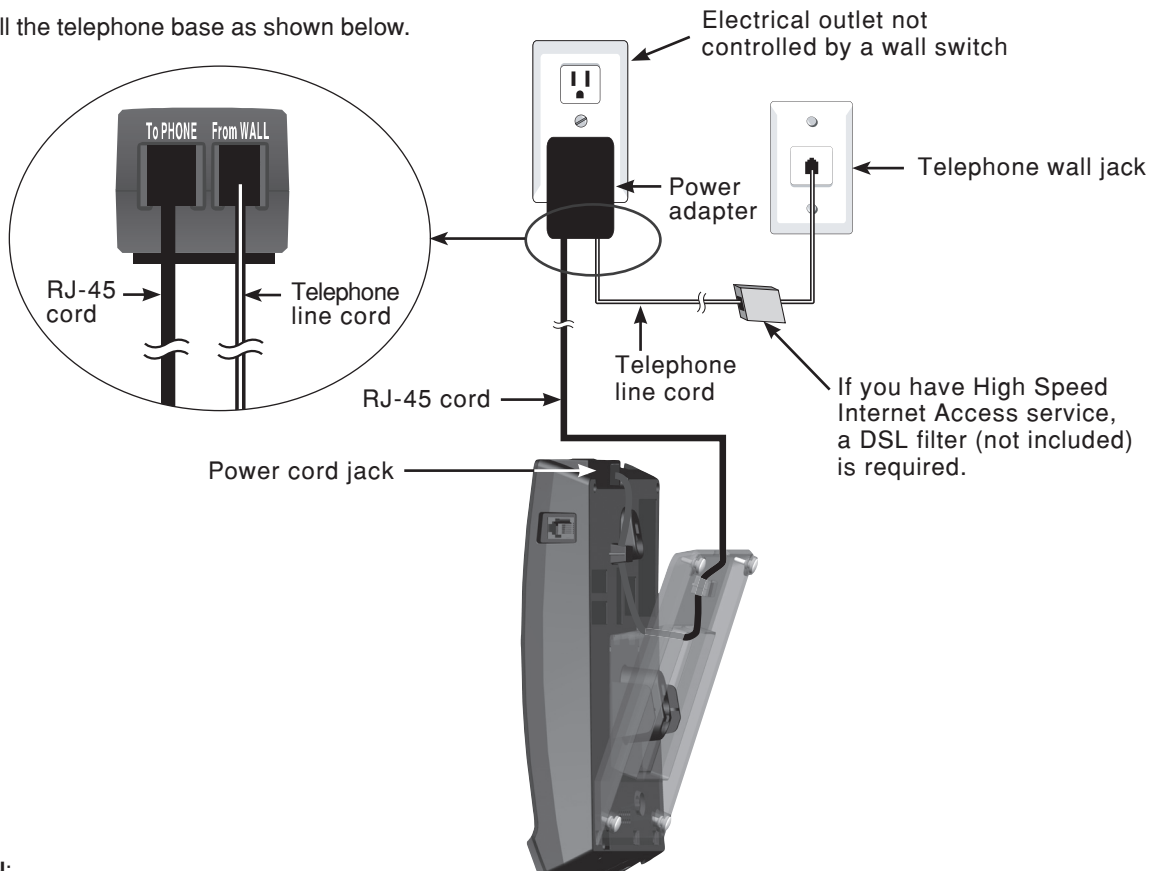

#### CAUTION:

Use only the supplied RJ-45 cord and power adapter. RJ-45 cord is not designed for use in any other IT devices. Misuse of RJ-45 cord on your other IT devices shall be prohibited. To order a replacement, visit our website at [www.vtechhotelphones.com](http://www.vtechhotelphones.com) or contact your local distributor.



# Installation

## Analog corded/cordless 1-line - CTM-A2510/CTM-A2510-USB

### Installation option - converting from desktop to wall mount position

#### To mount the telephone base on the wall:

1. Set aside the handset. On the telephone base cradle, place a coin in the slit of the wall mount clip and rotate a half turn (180 degrees). It locks into place with the protruding edge pointing towards the upper edge of the telephone base. This protruding edge holds the handset when the phone is mounted on the wall.

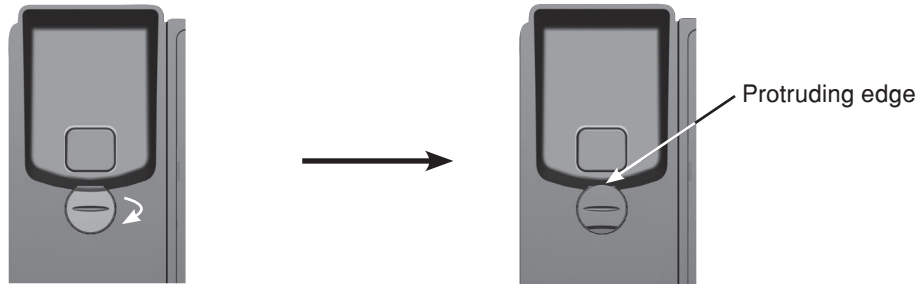

2. Turn the telephone base over with the bottom side facing up. To remove the mounting bracket, firmly push both tabs downward and pull up until both tabs release from the grooves.

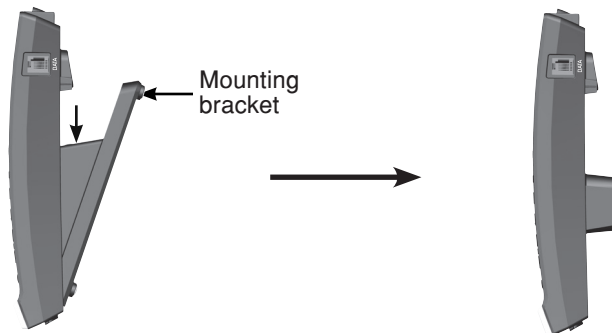

3. Mount the telephone base on the wall by aligning the eyelets with the mounting studs of the wall plate. Then slide the telephone base down on both mounting studs until it locks into place.

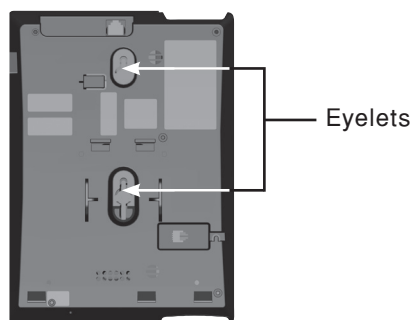

4. Place the handset on the telephone base cradle.

Installation

# Installation

## Analog corded/cordless 1-line - CTM-A2510/CTM-A2510-USB

### Handset battery installation

Install the battery as shown below.

1. Plug the battery connector securely into the socket inside the handset battery compartment.
2. Place the battery with the label **THIS SIDE UP** facing up and the wires inside the battery compartment.
3. To replace the handset cover, align all the tabs on the handset cover against the corresponding grooves on the handset, then firmly push downward until all the tabs lock in the grooves. Then install the screws at both ends of the handset.

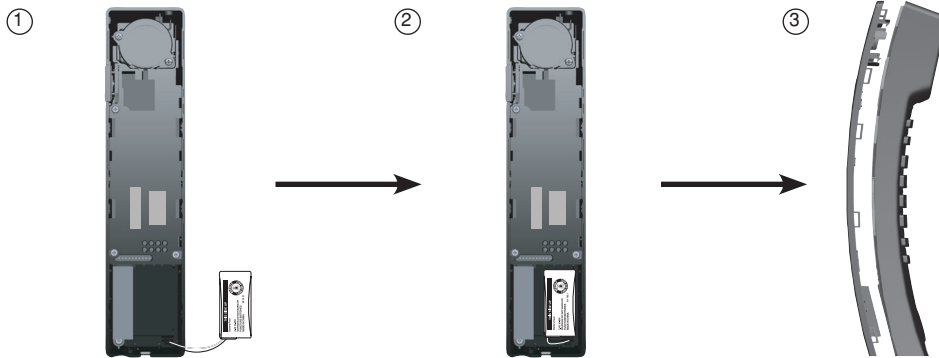

### Replace a handset battery

1. Use a 5 mm standard screwdriver to open the screw cover and remove the screw.
2. Insert the screwdriver in the provided slot and then twist and lift to open the bottom part.

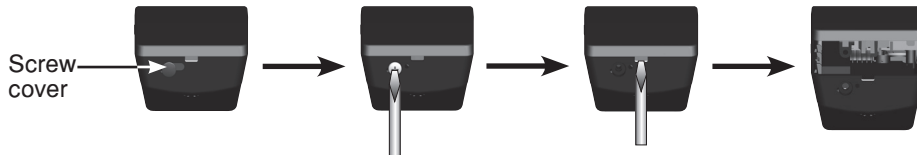

**-OR-**

Open the bottom part manually at the recessed area to avoid scratching the plastic.

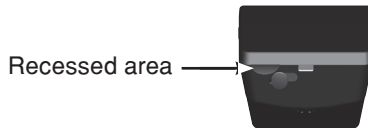

3. Use your thumb to slide along the sides of the handset carefully to release the tabs on the handset cover from the slots on the sides of the handset. Then gently detach the handset cover from the handset.

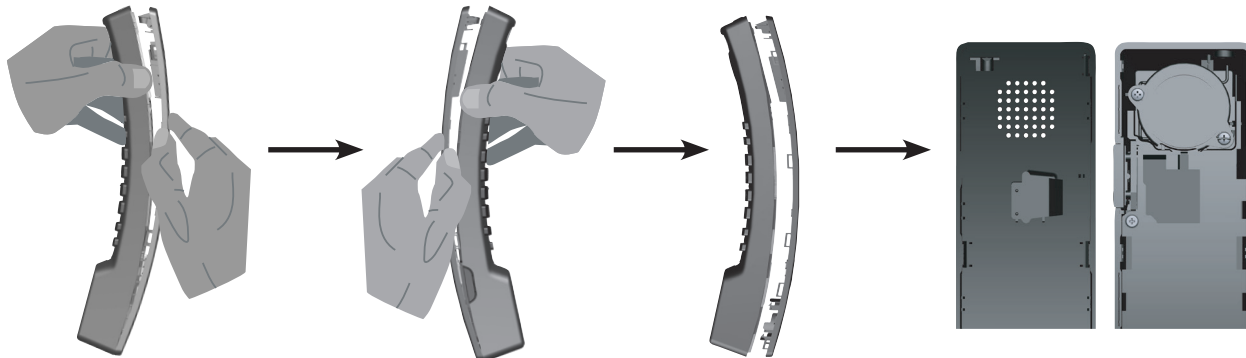

4. Unplug the battery connector from the socket and then remove the battery from the handset battery compartment.
5. Follow Step 2 to Step 4 in **Handset battery installation** above to install a new battery.

### CAUTIONS:

- There may be a risk of explosion if a wrong type of handset battery is used. Use only the supplied rechargeable battery (BT264392/BT266342) or replacement battery (BT266342). To order a replacement, visit our website at [www.vtechhotelphones.com](http://www.vtechhotelphones.com) or contact your local distributor.
- Dispose of used batteries according to the information in **Product disposal instructions** on page 86.

# Installation

## Analog corded/cordless 1-line - CTM-A2510/CTM-A2510-USB

### Handset registration

When the telephone base is idle, press **123** on the telephone base and then press **HOLD**. The **MESSAGE WAITING** LED on the base turns on for about 90 seconds. Press **123** on the cordless handset and then press **HOLD**. The **MESSAGE WAITING** LED on the handset turns on for 90 seconds. When the registration process completes, you hear 3 rising beeps as confirmation. When the telephone base has already registered 4 cordless handsets, one of the registered cordless handsets must be deregistered or registered to another telephone base before adding a new cordless handset.

### Handset deregistration

When a registered cordless handset is idle, press **\*331734#** and then press **HOLD**. You hear 3 rising beeps as confirmation when the deregistration process completes.

### Register a handset to another telephone base

Any **CTM-A2510/CTM-A2510-USB** handset can register to any **CTM-A2510/CTM-A2510-USB** telephone base. Deregister the registered cordless handset from its base (see **Handset deregistration** above) and then register it to a new telephone base (see **Handset registration** above).

### Handset battery charging

The battery must be fully charged before using the cordless handset for the first time. The **CHARGE** LED turns on when the cordless handset is charging on the charging base or charging stand. The battery is fully charged after 16 hours of continuous charging. For best performance, keep the cordless handset in the charging base or charging stand when not in use.

# Installation

## Analog corded/cordless 1-line - CTM-A2510/CTM-A2510-USB

### Charging stand installation

The charging stand is designed for desktop use. Install the charging stand as shown below.

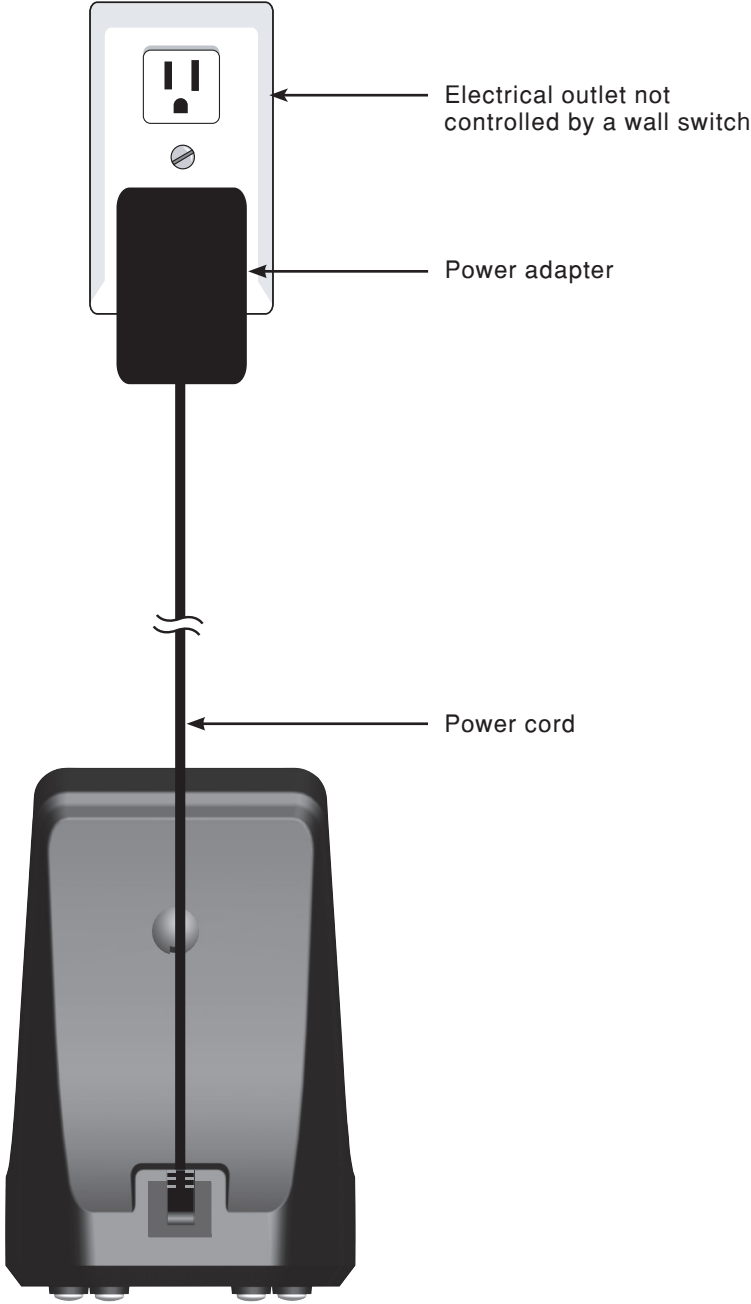

# Installation

## Analog cordless charging base - C4000

### Charging base installation

The charging base can be adapted to desktop use or mount on a standard telephone wall plate.

#### Installation option - desktop position

1. Turn the charging base over with the bottom side facing up. Position the mounting bracket as shown. Connect the power cord to the charging base and route the cord out from the large eyelet on the mounting bracket.

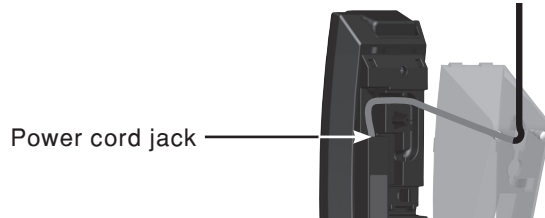

2. Insert the tabs of the mounting bracket as the direction shown below. Then tighten the screw to affix the mounting bracket.

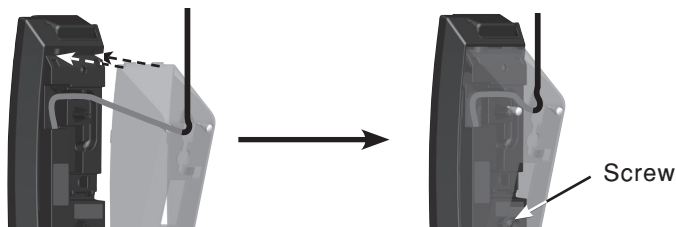

3. Plug the power adapter into an electrical outlet not controlled by a wall switch.

#### Installation option - converting from desktop to wall mount position

1. Unplug the power adapter from the electrical outlet.
2. Remove the cordless handset from the charging base if necessary. On the charging base cradle, place a coin in the slit of the wall mount clip and rotate a half turn (180 degrees). It locks into place with the protruding edge pointing towards the upper edge of the charging base. This protruding edge holds the cordless handset when the charging base is mounted on the wall.

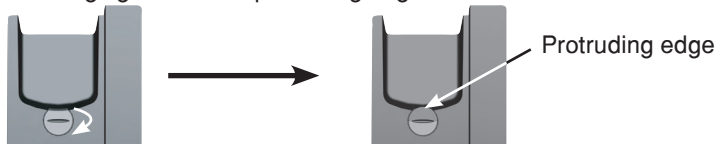

3. Loosen the screw from the mounting bracket and remove the mounting bracket from the grooves.



4. Turn the mounting bracket upside down. Insert the tabs of the mounting bracket into the lower grooves on the charging base. Then tighten the screw to affix the mounting bracket.

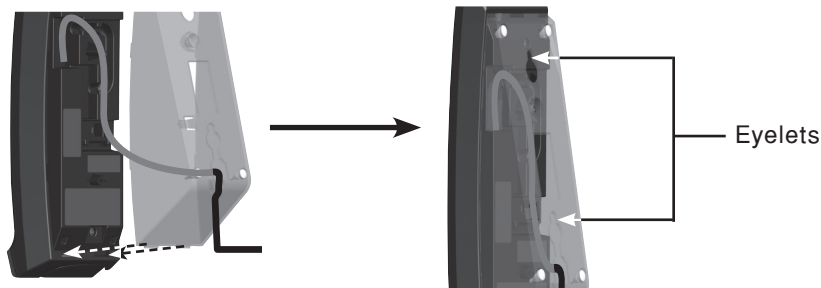

5. Mount the charging base on the wall by aligning the eyelets with the mounting studs of the wall plate. Then slide the charging base down on both mounting studs until it locks into place.
6. Plug the power adapter into an electrical outlet not controlled by a wall switch.

# Installation

## Analog cordless charging base - C4001

### Charging base installation

The charging base can be adapted to desktop use or mount on a standard telephone wall plate.

#### Installation option - desktop position

1. Turn the charging base over with the bottom side facing up. Position the mounting bracket as shown. Connect the power cord to the charging base and route the cord out from the large eyelet on the mounting bracket.

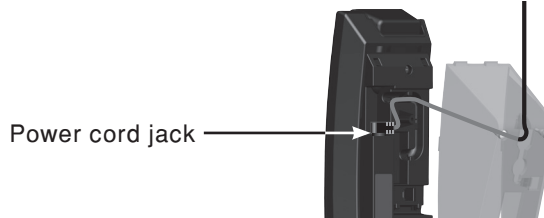

2. Insert the tabs of the mounting bracket as the direction shown below. Then tighten the screw to affix the mounting bracket.

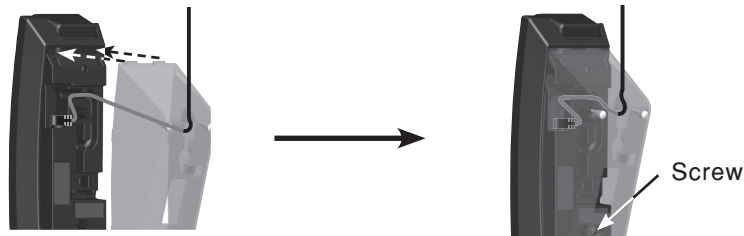

3. Plug the power adapter into an electrical outlet not controlled by a wall switch.

#### Installation option - converting from desktop to wall mount position

1. Unplug the power adapter from the electrical outlet.
2. Remove the cordless handset from the charging base if necessary. On the charging base cradle, place a coin in the slit of the wall mount clip and rotate a half turn (180 degrees). It locks into place with the protruding edge pointing towards the upper edge of the charging base. This protruding edge holds the cordless handset when the charging base is mounted on the wall.

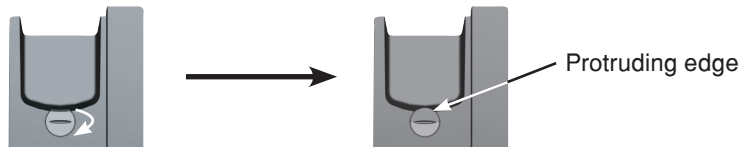

3. Loosen the screw from the mounting bracket and remove the mounting bracket from the grooves.

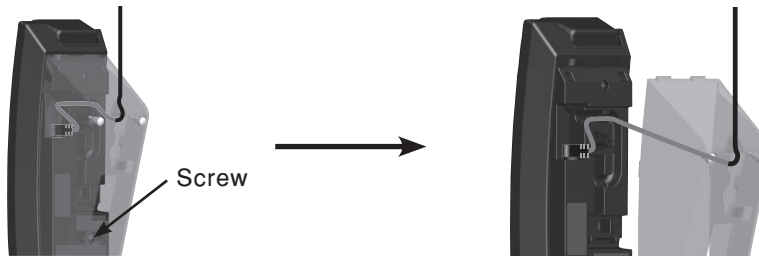

4. Rotate the mounting bracket. Insert the tabs of the mounting bracket into the lower grooves on the charging base. Then tighten the screw to affix the mounting bracket.

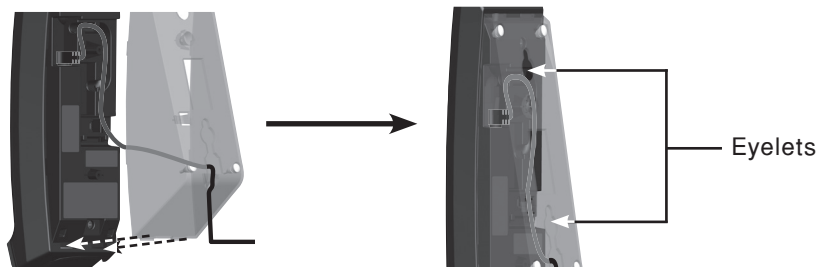

5. Mount the charging base on the wall by aligning the eyelets with the mounting studs of the wall plate. Then slide the charging base down on both mounting studs until it locks into place.
6. Plug the power adapter into an electrical outlet not controlled by a wall switch.

# Installation

## Analog cordless charging stand - C4010

### Charging stand installation

The charging stand is designed for desktop use. Install the charging stand as shown below.

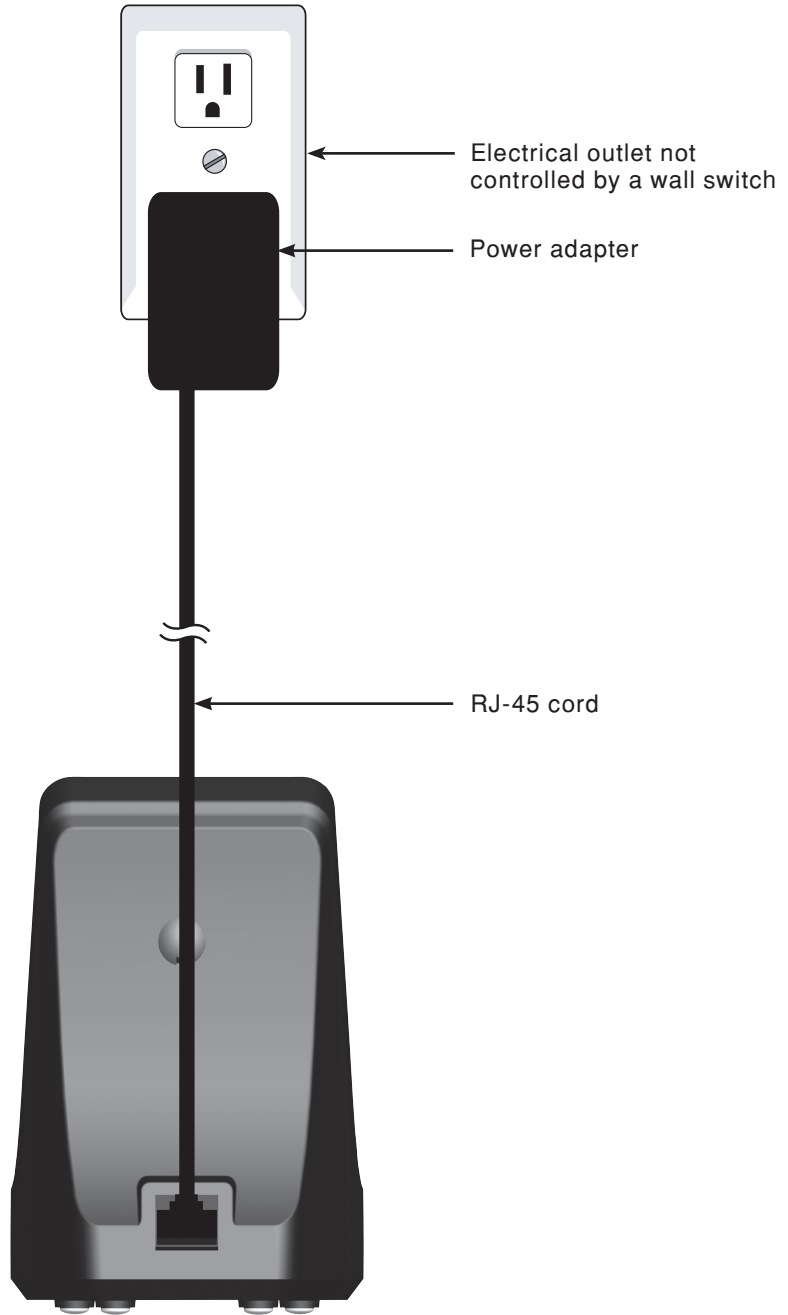

# Installation

## Analog cordless charging stand - C4011/C4011-USB/CTM-A241HS/CTM-A241SD/CTM-A242HS/CTM-A242SD

### Charging stand installation

The charging stand is designed for desktop use. Install the charging stand as shown below.

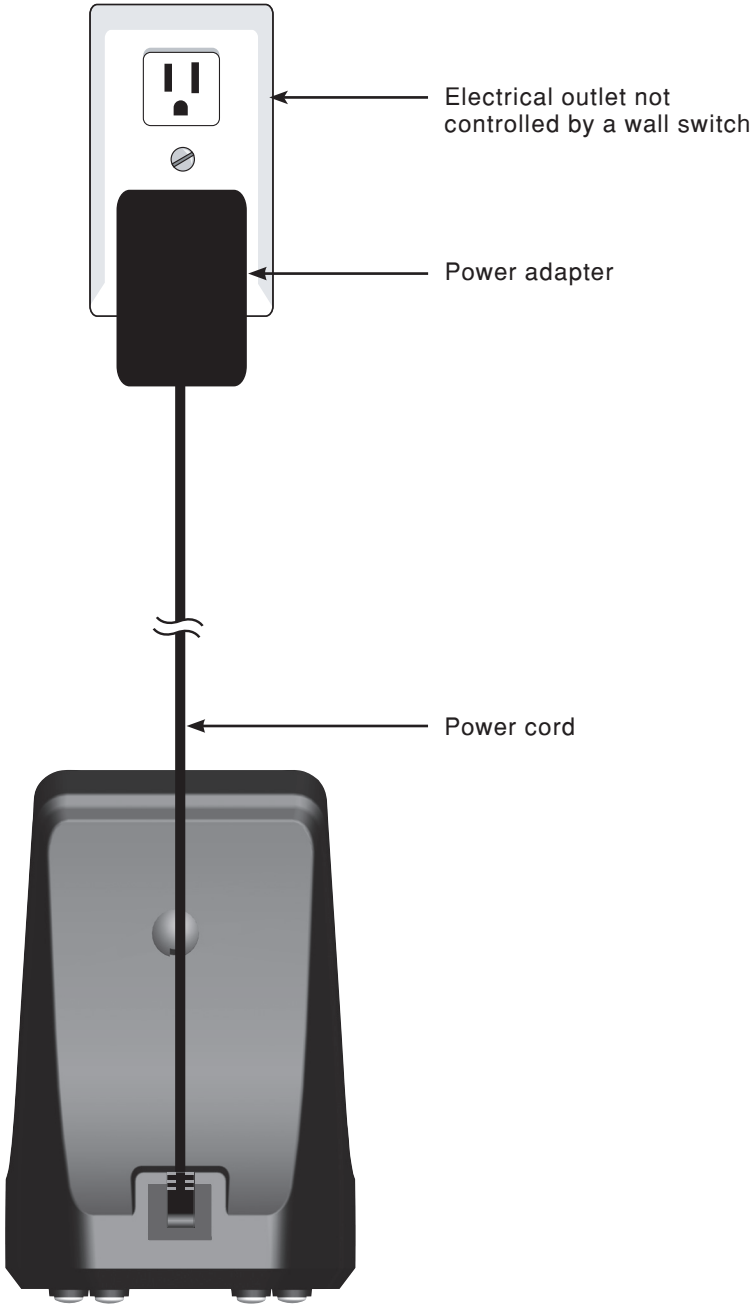



# Installation

## Analog cordless 1-line/2-line accessory handset - C4100/C4200/CTM-A241HS/CTM-A242HS

### Handset battery installation

Install the battery as shown below.

1. Gently lift the handset cover. Do not detach the speaker wires between the handset cover and the handset.
2. Plug the battery connector securely into the socket inside the handset battery compartment.
3. Place the battery with the label **THIS SIDE UP** facing up and the wires inside the battery compartment.
4. To replace the handset cover, align all the tabs on the handset cover against the corresponding grooves on the handset, then firmly push downward until all the tabs lock in the grooves. Then install the screw at the bottom of the handset.

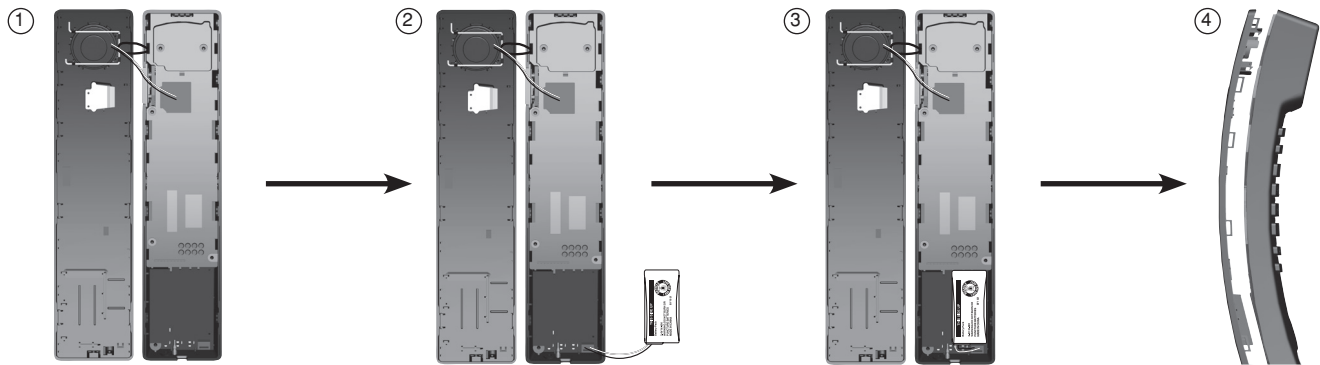

### Replace a handset battery

1. Use a 5 mm standard screwdriver to open the screw cover and remove the screw. Insert the screwdriver in the provided slot and then twist and lift to open the bottom part.

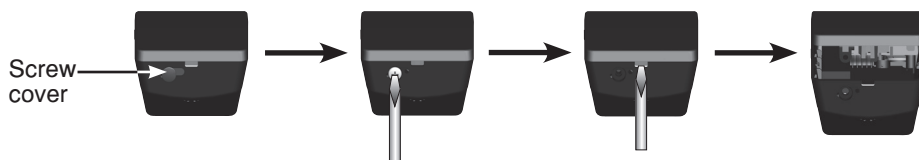

2. Use your thumb to slide along the sides of the handset carefully to release the tabs on the handset cover from the slots on the sides of the handset. Then gently detach the handset cover from the handset.



Do not detach the speaker wires between the handset cover and the handset.

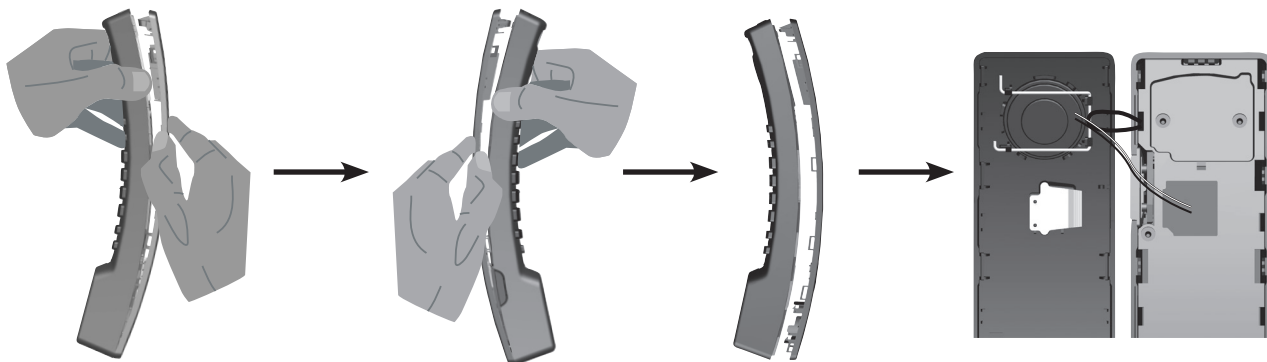

3. Unplug the battery connector from the socket and then remove the battery from the handset battery compartment.
4. Follow Step 2 to Step 4 in **Handset battery installation** above to install a new battery.

### CAUTIONS:

- There may be a risk of explosion if a wrong type of handset battery is used. Use only the supplied rechargeable battery (BT264392/BT266342) or replacement battery (BT266342). To order a replacement, visit our website at [www.vtechhotelphones.com](http://www.vtechhotelphones.com) or contact your local distributor.
- Dispose of used batteries according to the information in **Product disposal instructions** on page 86.

Installation

## Installation

### Analog cordless 1-line/2-line accessory handset - C4100/C4200/CTM-A241HS/CTM-A242HS

#### Handset registration

Place the cordless handset on the telephone base cradle. Handset registration happens automatically the first time a cordless handset is placed on the telephone base. When the registration process completes, the **MESSAGE WAITING** LED flashes once and you hear 3 rising beeps as confirmation. Each telephone base accommodates up to 4 cordless handsets. When the telephone base has already registered 4 cordless handsets, one of the registered cordless handsets must be deregistered or registered to another telephone base before adding a new cordless handset.

#### Handset deregistration

When a registered cordless handset is idle, press **\*331734#** and then press **HOLD**. You hear 3 rising beeps as confirmation when the deregistration process completes.

#### Register a handset to another telephone base

Any **C4100/CTM-A241HS** handset can register to any **A2410** telephone base. Any **C4200/CTM-A242HS** handset can register to any **A2420** telephone base.

When a registered cordless handset is idle, place it on another telephone base. This cordless handset automatically registers to the new telephone base.

#### Handset battery charging

The battery must be fully charged before using the cordless handset for the first time. The **CHARGE** LED turns on when the cordless handset is charging on the telephone base, charging base or charging stand. The battery is fully charged after 16 hours of continuous charging. For best performance, keep the cordless handset in the telephone base, charging base or charging stand when not in use.

## Installation

### Analog cordless 1-line/2-line accessory handset - CTM-A241SD/CTM-A242SD/CTM-C4101/CTM-C4201

#### Handset battery installation

Install the battery as shown below.

1. Plug the battery connector securely into the socket inside the handset battery compartment.
2. Place the battery with the label **THIS SIDE UP** facing up and the wires inside the battery compartment.
3. To replace the handset cover, align all the tabs on the handset cover against the corresponding grooves on the handset, then firmly push downward until all the tabs lock in the grooves. Then install the screws at both ends of the handset.

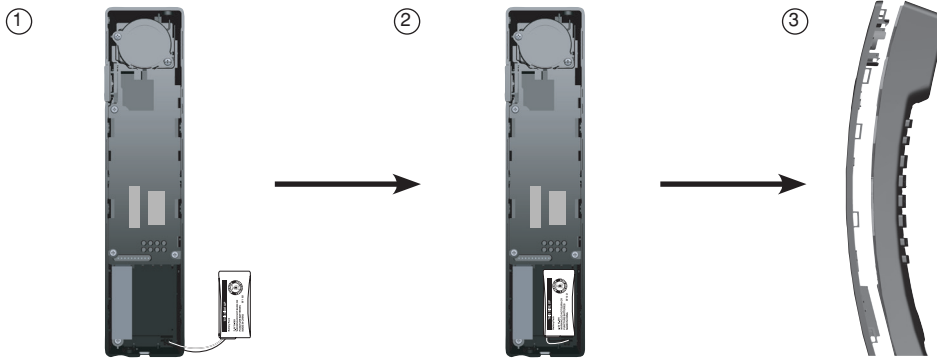

#### Replace a handset battery

1. Use a 5 mm standard screwdriver to open the screw cover and remove the screw.
2. Insert the screwdriver in the provided slot and then twist and lift to open the bottom part.

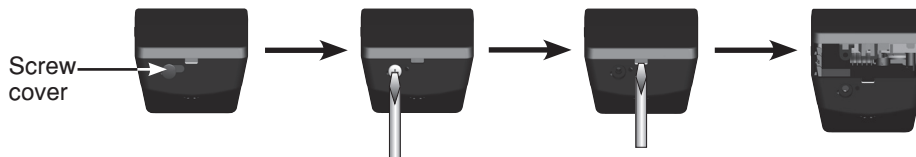

**-OR-**

Open the bottom part manually at the recessed area to avoid scratching the plastic.



3. Use your thumb to slide along the sides of the handset carefully to release the tabs on the handset cover from the slots on the sides of the handset. Then gently detach the handset cover from the handset.

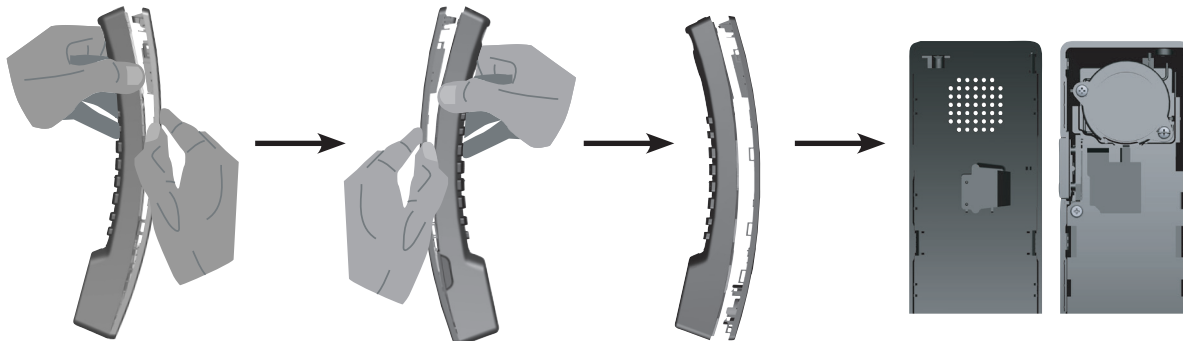

4. Unplug the battery connector from the socket and then remove the battery from the handset battery compartment.
5. Follow Step 2 to Step 4 in **Handset battery installation** above to install a new battery.

#### CAUTIONS:

- There may be a risk of explosion if a wrong type of handset battery is used. Use only the supplied rechargeable battery (BT264392/BT266342) or replacement battery (BT266342). To order a replacement, visit our website at [www.vtechhotelphones.com](http://www.vtechhotelphones.com) or contact your local distributor.
- Dispose of used batteries according to the information in **Product disposal instructions** on page 86.

## Installation

### Analog cordless 1-line/2-line accessory handset - CTM-A241SD/CTM-A242SD/CTM-C4101/CTM-C4201

#### Handset registration

**To register a cordless handset to an A2410/A2420/CTM-A2411/CTM-A2411-BATT/CTM-A2421/CTM-A2421-BATT telephone base:**

Place the cordless handset on the telephone base cradle. Handset registration happens automatically the first time a cordless handset is placed on the telephone base. When the registration process completes, the **MESSAGE WAITING** LED flashes once and you hear 3 rising beeps as confirmation. Each telephone base accommodates up to 4 cordless handsets or accessory Petite phones. When the telephone base has already registered 4 cordless handsets or accessory Petite phones, one of the registered cordless handsets or accessory Petite phones must be deregistered or registered to another telephone base before adding a new cordless handset or accessory Petite phone.

**To register a cordless handset to a CTM-A2411/CTM-A2411-BATT/CTM-A2421/CTM-A2421-BATT/CTM-A2510/CTM-A2510-USB telephone base without placing it on the telephone base:**

When the telephone base is idle, press **123** on the telephone base and then press **HOLD**. The **MESSAGE WAITING** LED on the base turns on for about 90 seconds. Press **123** on the cordless handset and then press **HOLD**. The **MESSAGE WAITING** LED on the handset turns on for 90 seconds. When the registration process completes, you hear 3 rising beeps as confirmation. When the telephone base has already registered 4 cordless handsets or accessory Petite phones, one of the registered cordless handsets or accessory Petite phones must be deregistered or registered to another telephone base before adding a new cordless handset or accessory Petite phone.

#### Handset deregistration

When a registered cordless handset is idle, press **\*331734#** and then press **HOLD**. You hear 3 rising beeps as confirmation when the deregistration process completes.

#### Register a handset to another telephone base

Any **CTM-A241SD/CTM-C4101** handset can register to any **A2410/CTM-A2411/CTM-A2411-BATT/CTM-A2510/CTM-A2510-USB** telephone base. Any **CTM-A242SD/CTM-C4201** handset can register to any **A2421/CTM-A2421/CTM-A2421-BATT** telephone base.

Deregister the registered cordless handset from its base (see **Handset deregistration** above) and then register it to a new telephone base (see **Handset registration** above).

#### Handset battery charging

The battery must be fully charged before using the cordless handset for the first time. The **CHARGE** LED turns on when the cordless handset is charging on the telephone base, charging base or charging stand. The battery is fully charged after 16 hours of continuous charging. For best performance, keep the cordless handset in the telephone base, charging base or charging stand when not in use.

# Telephone settings

## Analog corded lobby/1-line/2-line/trimstyle - A2100/A2210/A2220/A2310

Default settings are indicated by asterisks (\*).

Setting	Options	Adjustable by:
<b>Handset earpiece volume</b> (for models <b>A2210</b> and <b>A2220</b> only)	1, 2*, 3, 4	User and administrator
<b>Handset earpiece volume</b> (for model <b>A2310</b> only)	1, 2, 3*, 4, 5	User and administrator
<b>Speakerphone volume</b> (for models <b>A2210</b> and <b>A2220</b> only)	1, 2, 3, 4, 5*, 6, 7, 8	User and administrator
<b>Ringer volume</b>	Low, Medium*, High	User and administrator
<b>Ringer tone</b>	Tone 1*, Tone 2, Tone 3	Administrator only
<b>Flash</b> (for models <b>A2210</b> and <b>A2220</b> only)	1 (100ms), 2 (300ms), 3* (600ms)	Administrator only
<b>Voicemail voltage detection</b> (for models <b>A2210</b> , <b>A2220</b> and <b>A2310</b> only)	Disable voicemail voltage detection, Periodic low voltage pulse detection method, Steady high voltage and periodic high voltage pulse detection method	Administrator only

### Ringer tone

There are 3 ringer tone options. For 2-line model (**A2220**), changing the ringer tone of either **LINE 1** or **LINE 2** applies to both phone lines.

#### To change the ringer tone:

- Turn the telephone base over with the bottom side facing up.
  - For lobby (**A2100**), 1-line (**A2210**) and 2-line (**A2220**) models, remove the mounting bracket if it is in desktop position. To remove the mounting bracket, firmly push both tabs downward and pull up until they release from the grooves.
  - For trimstyle model (**A2310**), remove the mounting bracket. To remove the mounting bracket, firmly press down the tab on it and pull out to detach it from the telephone base.

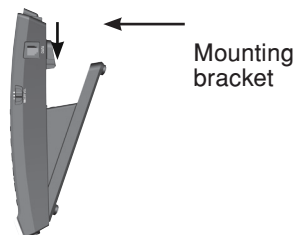

(For **A2100**, **A2210** or **A2220**)

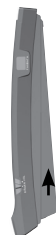

(For **A2310**)

- Slide the ringer tone switch to select the desired detented position using a narrow object such as a standard screwdriver.

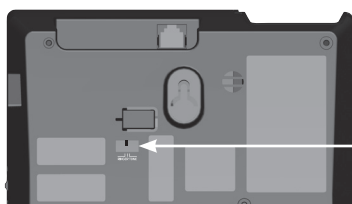

(For **A2100**, **A2210** or **A2220**)

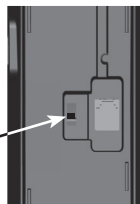

(For **A2310**)

- Install the mounting bracket accordingly.

### Flash

For 1-line and 2-line models (**A2210** and **A2220**), there are 3 flash duration options that can be programmed.

#### To change the flash duration:

- Remove the faceplate and overlay if they are on the telephone base. Press **☎/SPEAKER** on the telephone base or lift the handset. Then press the recessed **PROGRAM** key. The **MUTE** key flashes when in administrator mode.
- Press **FLASH** and you hear 3 beeps. Then press a dialing key, **1** (100ms), **2** (300ms) or **3** (600ms), to select the desired flash duration. Press the recessed **PROGRAM** key again. You hear 3 rising beeps as confirmation.

# Telephone settings

## Analog corded lobby/1-line/2-line/trimstyle - A2100/A2210/A2220/A2310

### Voicemail voltage detection

For 1-line and 2-line models (**A2210** and **A2220**), there are 3 options to set the voicemail voltage detection on the telephone base.

#### To disable the voicemail voltage detection:

1. Remove the faceplate and overlay if they are on the telephone base. Then remove the sticker on the telephone base.
2. Use a narrow object to unplug all the jumpers from the telephone base.
3. Place the sticker back in place.

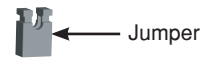

#### To set the voicemail voltage detection by the periodic low voltage pulse detection method:

1. Remove the faceplate and overlay if they are on the telephone base. Then remove the sticker on the telephone base.
2. Use a narrow object to unplug all the jumpers from the telephone base. Then plug the jumpers into ①, ② and ③.
3. Place the sticker back in place.

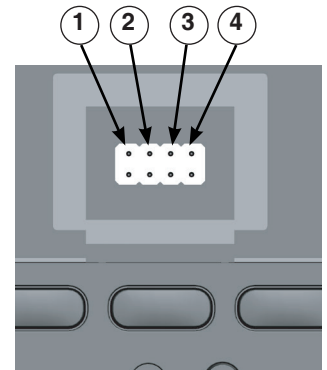

#### To set the voicemail voltage detection by the steady high voltage and periodic high voltage pulse detection method:

1. Remove the faceplate and overlay if they are on the telephone base. Then remove the sticker on the telephone base.
2. Use a narrow object to unplug all the jumpers from the telephone base. Then plug the jumpers into ①, ② and ④.
3. Place the sticker back in place.

For trimstyle model (**A2310**), there are 3 options to set the voicemail voltage detection on the telephone base.

#### To disable the voicemail voltage detection:

1. Remove the sticker at the bottom of the telephone base.
2. Use a narrow object to unplug all the jumpers from the telephone base.
3. Place the sticker back in place.

#### To set the voicemail voltage detection by the periodic low voltage pulse detection method:

1. Remove the sticker at the bottom of the telephone base.
2. Use a narrow object to unplug all the jumpers from the telephone base. Then plug the jumpers into ①, ② and ③.
3. Place the sticker back in place.

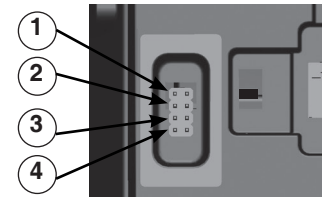

#### To set the voicemail voltage detection by the steady high voltage and periodic high voltage pulse detection method:

1. Remove the sticker at the bottom of the telephone base.
2. Use a narrow object to unplug all the jumpers from the telephone base. Then plug the jumpers into ①, ② and ④.
3. Place the sticker back in place.

### Speed Dial keys

For 1-line and 2-line models (**A2210** and **A2220**), there are up to 10 programmable guest-service (Speed Dial) keys. Program these keys to automatically dial telephone numbers or to activate telephone system features.

#### To program a Speed Dial key:

1. Remove the faceplate and overlay if they are on the telephone base. Press **Ⓜ/SPEAKER** on the telephone base or lift the handset. Then press the recessed **PROGRAM** key. The **MUTE** key flashes when in administrator mode.
2. Press the desired Speed Dial key where the telephone number is to be stored. You hear 3 beeps.
3. Enter the telephone number (up to 16 digits).
  - To insert a pause in the stored number, press the recessed **PAUSE** key.
4. The telephone stores the number automatically when 16 digits are entered. When the number has less than 16 digits, press the recessed **PROGRAM** key again. You hear 3 rising beeps as confirmation.

#### To clear the programmed Speed Dial key:

1. Remove the faceplate and overlay if they are on the telephone base. Press **Ⓜ/SPEAKER** on the telephone base or lift the handset. Then press the recessed **PROGRAM** key. The **MUTE** key flashes when in administrator mode.
2. Press the Speed Dial key where the telephone number is to be deleted. You hear 3 beeps. Press the recessed **PROGRAM** key again. You hear 3 rising beeps as confirmation.

## Telephone settings

Analog cordless 1-line/2-line - A2410/CTM-A2411/CTM-A2411-BATT/A2420/CTM-A2421/  
CTM-A2421-BATT

Analog corded/cordless 1-line - CTM-A2510/CTM-A2510-USB

Analog cordless 1-line/2-line accessory handset - CTM-A241SD/CTM-A242SD/CTM-C4101/  
CTM-C4201

Analog cordless 1-line/2-line accessory Petite - CTM-A241P/CTM-A242P

Default settings are indicated by asterisks (\*).

Setting	Options	Adjustable by:
Listening volume - handset	1, 2, 3, 4*, 5, 6	User and administrator
Speakerphone volume - handset	1, 2, 3, 4*, 5, 6	User and administrator
Speakerphone volume - telephone base	1, 2, 3, 4*, 5, 6	User and administrator
Ringer volume - telephone base	1, 2*, 3	User and administrator
Ringer tone - telephone base	Tone 1*, Tone 2, Tone 3	Administrator only
Flash	1 (100ms), 2 (300ms), 3* (600ms)	Administrator only
RF transmission power - telephone base	1 (low), 2* (middle), 3 (high)	Administrator only
Hold	00 (auto-release disabled), 01 - 14, 15*, 16 - 99 minutes	Administrator only
Voicemail voltage detection - • Steady high voltage, periodic high voltage pulse and periodic low voltage pulse detection method* • FSK detection method* • Panasonic	0 (disable), 1 (enable)	Administrator only
Voicemail voltage detection - • Line reversal method	0 (disable), 1 (auto), 2 (default 0), 3 (default 1)	Administrator only
Voicemail voltage detection - • Siemens	0 (disable), 1 (50Hz), 2 (25Hz), 3 (20Hz)	Administrator only
Speed Dial number share	0 (disable), 1 (enable)	Administrator only

### Ringer tone

There are 3 ringer tones options that can be assigned to the telephone base. For 2-line models (A2420/CTM-A2421/CTM-A2421-BATT), changing the ringer tone of either **LINE 1** or **LINE 2** applies to both phone lines.

#### To change the ringer tone:

1. Remove the faceplate and overlay if they are on the telephone base. Then press the recessed **PROGRAM** key.
2. Press **00** and you hear 3 beeps. Then press a dialing key, **1**, **2** or **3**, to select the desired ringer tone. You hear 3 rising beeps as confirmation.

### Flash

There are 3 flash duration options that can be programmed.

#### To change the flash duration:

1. Remove the faceplate and overlay if they are on the telephone base. Then press the recessed **PROGRAM** key.
2. Press **FLASH** and you hear 3 beeps. Then press a dialing key, **1** (100ms), **2** (300ms) or **3** (600ms), to select the desired flash duration. You hear 3 rising beeps as confirmation.

### RF transmission power

There are 3 RF transmission power options on the telephone base that can be programmed.

#### To change the RF transmission power control level:

1. Remove the faceplate and overlay if they are on the telephone base. Then press the recessed **PROGRAM** key.
2. Press **01** and you hear 3 beeps. Then press a dialing key, **1** (low - coverage of 25% of maximum working distance), **2** (middle - coverage of 50% maximum working distance) or **3** (high - coverage of 100% of maximum working distance), to select the desired RF transmission power control level. You hear 3 rising beeps as confirmation.

## Telephone settings

**Analog cordless 1-line/2-line - A2410/CTM-A2411/CTM-A2411-BATT/A2420/CTM-A2421/  
CTM-A2421-BATT**

**Analog corded/cordless 1-line - CTM-A2510/CTM-A2510-USB**

**Analog cordless 1-line/2-line accessory handset - CTM-A241SD/CTM-A242SD/CTM-C4101/  
CTM-C4201**

**Analog cordless 1-line/2-line accessory Petite - CTM-A241P/CTM-A242P**

### Hold

The call on hold timeout duration can be programmed from 01 to 99 minutes. Select **00** to disable the auto-release feature on call on hold.

#### To change the call on hold timeout duration:

1. Remove the faceplate and overlay if they are on the telephone base. Then press the recessed **PROGRAM** key.
2. Press **02** and you hear 3 beeps. Then press the dialing keys from **00** to **99** minutes. You hear 3 rising beeps as confirmation.

### Voicemail voltage detection

There are several voicemail voltage detection methods on the telephone base that can be programmed.

#### To disable the voicemail voltage detection:

1. Remove the faceplate and overlay if they are on the telephone base.
2. Press the recessed **PROGRAM** key, then press **100**.
3. Press the recessed **PROGRAM** key, then press **110**.
4. Press the recessed **PROGRAM** key, then press **120**.
5. Press the recessed **PROGRAM** key, then press **130**.
6. Press the recessed **PROGRAM** key, then press **140**.

#### To set the voicemail voltage detection by the steady high voltage, periodic high voltage pulse and periodic low voltage pulse detection method:

1. Follow Step 1 to Step 6 in **To disable the voicemail voltage detection** above.
2. Press the recessed **PROGRAM** key.
3. Press **10** and you hear 3 beeps. Then press **1** to enable the setting. You hear 3 rising beeps as confirmation.

#### To set the voicemail voltage detection by the line reversal method:

1. Follow Step 1 to Step 6 in **To disable the voicemail voltage detection** above.
2. Disable voicemail signal to the telephone.
3. Press the recessed **PROGRAM** key.
4. Press **11** and you hear 3 beeps. Then press **1** (auto). You hear 3 rising beeps as confirmation.
5. Get a dial tone. Wait for about 3 seconds and then hang up.
6. After about 15 seconds, when the **MESSAGE WAITING** LED is off, enable voicemail signal to the telephone.
7. After about 15 seconds, when the **MESSAGE WAITING** LED is on, disable voicemail signal to the telephone. After about 15 seconds, the **MESSAGE WAITING** LED is off if you successfully completes the setting.

If you fail to set the above setting, follow below steps to set another setting.

1. Follow Step 1 to Step 6 in **To disable the voicemail voltage detection** above.
2. Disable voicemail signal to the telephone.
3. Press the recessed **PROGRAM** key.
4. Press **11** and you hear 3 beeps. Then press **2** (default 0) or **3** (default 1). You hear 3 rising beeps as confirmation. After about 15 seconds, if the **MESSAGE WAITING** LED is on, repeat the steps above to try another setting.
5. After about 15 seconds, when the **MESSAGE WAITING** LED is off, enable voicemail signal to the telephone.
6. After about 15 seconds, when the **MESSAGE WAITING** LED is on, disable voicemail signal to the telephone. After about 15 seconds, the **MESSAGE WAITING** LED is off if you successfully completes the setting.

#### To set the voicemail voltage detection by the FSK detection method:

1. Follow Step 1 to Step 6 in **To disable the voicemail voltage detection** above.
2. Press the recessed **PROGRAM** key.
3. Press **12** and you hear 3 beeps. Then press **1** to enable the setting. You hear 3 rising beeps as confirmation.



## Telephone settings

**Analog cordless 1-line/2-line - A2410/CTM-A2411/CTM-A2411-BATT/A2420/CTM-A2421/  
CTM-A2421-BATT**

**Analog corded/cordless 1-line - CTM-A2510/CTM-A2510-USB**

**Analog cordless 1-line/2-line accessory handset - CTM-A241SD/CTM-A242SD/CTM-C4101/  
CTM-C4201**

**Analog cordless 1-line/2-line accessory Petite - CTM-A241P/CTM-A242P**

**To set the voicemail voltage detection by the Siemens detection method:**

1. Follow Step 1 to Step 6 in **To disable the voicemail voltage detection** above.
2. Disable voicemail signal to the telephone.
3. Press the recessed **PROGRAM** key.
4. Press **13** and you hear 3 beeps. Then press **1** (50Hz), **2** (25Hz) or **3** (20Hz). You hear 3 rising beeps as confirmation.
5. After about 15 seconds, when the **MESSAGE WAITING** LED is off, enable voicemail signal to the telephone. After about 15 seconds, if the **MESSAGE WAITING** LED is still off, repeat the steps above to try another setting.
6. Disable voicemail signal to the telephone. After about 15 seconds, the **MESSAGE WAITING** LED is off if you successfully completes the setting.

**To set the voicemail voltage detection by the Panasonic detection method:**

1. Follow Step 1 to Step 6 in **To disable the voicemail voltage detection** above.
2. Press the recessed **PROGRAM** key.
3. Press **14** and you hear 3 beeps. Then press **1** to enable the setting. You hear 3 rising beeps as confirmation.

### Speed Dial keys

For an **A2410/A2420** telephone base, there are up to 10 programmable guest-service (Speed Dial) keys. For a **CTM-A2411/CTM-A2411-BATT/CTM-A2421/CTM-A2421-BATT/CTM-A2510/CTM-A2510-USB** telephone base, there are up to 11 programmable guest-service (Speed Dial) keys. Program these keys to automatically dial telephone numbers or to activate telephone system features.

**To program a Speed Dial key on the telephone base:**

1. Remove the faceplate and overlay if they are on the telephone base. Then press the recessed **PROGRAM** key.
2. Press the desired Speed Dial key where the telephone number is to be stored. You hear 3 beeps.
3. Enter the telephone number (up to 32 digits).
  - To insert a pause in the stored number, press the recessed **PAUSE** key.
4. The telephone stores the number automatically when 32 digits are entered. When the number has less than 32 digits, press the recessed **PROGRAM** key again. You hear 3 rising beeps as confirmation.

**To clear the programmed Speed Dial key on the telephone base:**

1. Remove the faceplate and overlay if they are on the telephone base. Then press the recessed **PROGRAM** key.
2. Press the Speed Dial key where the telephone number is to be deleted. You hear 3 beeps. Press the recessed **PROGRAM** key again. You hear 3 rising beeps as confirmation.

For a **CTM-A2411/CTM-A2411-BATT/CTM-A2421/CTM-A2421-BATT/CTM-A2510/CTM-A2510-USB/CTM-A241SD/CTM-A242SD/CTM-C4101/CTM-C4201** cordless handset, there are 3 programmable keys. Program these keys to automatically dial telephone numbers or to activate telephone system features.

**To program the MESSAGES key on the cordless handset:**

1. Remove the faceplate and overlay if they are on the telephone base. Then press the recessed **PROGRAM** key.
2. Press **60** and you hear 3 beeps.
3. Enter the telephone number (up to 32 digits).
  - To insert a pause in the stored number, press the recessed **PAUSE** key.
4. The telephone stores the number automatically when 32 digits are entered. When the number has less than 32 digits, press the recessed **PROGRAM** key again. You hear 3 rising beeps as confirmation.

**To clear the programmed MESSAGES key on the cordless handset:**

1. Remove the faceplate and overlay if they are on the telephone base. Then press the recessed **PROGRAM** key.
2. Press **60** and you hear 3 beeps.
3. Press the recessed **PROGRAM** key again. You hear 3 rising beeps as confirmation.

## Telephone settings

### Analog cordless 1-line/2-line - A2410/CTM-A2411/CTM-A2411-BATT/A2420/CTM-A2421/ CTM-A2421-BATT

### Analog corded/cordless 1-line - CTM-A2510/CTM-A2510-USB

### Analog cordless 1-line/2-line accessory handset - CTM-A241SD/CTM-A242SD/CTM-C4101/ CTM-C4201

### Analog cordless 1-line/2-line accessory Petite - CTM-A241P/CTM-A242P

#### To program a Speed Dial key on the cordless handset:

1. Remove the faceplate and overlay if they are on the telephone base. Then press the recessed **PROGRAM** key.
2. Press **61** or **62** for the desired Speed Dial key where the telephone number is to be stored (**61** indicates the Speed Dial key below **REDIAL** key and **62** indicates the Speed Dial key below **MUTE** key) and you hear 3 beeps.
3. Enter the telephone number (up to 32 digits).
  - To insert a pause in the stored number, press the recessed **PAUSE** key.
4. The telephone stores the number automatically when 32 digits are entered. When the number has less than 32 digits, press the recessed **PROGRAM** key again. You hear 3 rising beeps as confirmation.

#### To clear the programmed Speed Dial key:

1. Remove the faceplate and overlay if they are on the telephone base. Then press the recessed **PROGRAM** key.
2. Press **61** or **62** for the desired Speed Dial key where the telephone number is to be deleted (**61** indicates the Speed Dial key below **REDIAL** key and **62** indicates the Speed Dial key below **MUTE** key) and you hear 3 beeps.
3. Press the recessed **PROGRAM** key again. You hear 3 rising beeps as confirmation.

When a **CTM-A241SD/CTM-A242SD/CTM-C4101/CTM-C4201** is registered to an **A2410/A2420** telephone base, you can program these keys using the cordless handset.

#### To program the MESSAGES/Speed Dial key on a CTM-A241SD/CTM-A242SD/CTM-C4101/CTM-C4201 cordless handset:

1. Press **234** and then **HOLD** when the cordless handset is not in use.
2. Press the **MESSAGES** key or the desired Speed Dial key where the telephone number is to be stored. You hear 3 beeps.
3. Enter the telephone number (up to 32 digits).
  - To insert a pause in the stored number, press the recessed **PAUSE** key.
4. The telephone stores the number automatically when 32 digits are entered. When the number has less than 32 digits, press the desired Speed Dial key where the telephone number is to be stored. You hear 3 rising beeps as confirmation.

#### To clear the MESSAGES/Speed Dial key on a CTM-A241SD/CTM-A242SD/CTM-C4101/CTM-C4201 cordless handset:

1. Press **234** and then **HOLD** when the cordless handset is not in use.
2. Press the **MESSAGES** key or the desired Speed Dial key where the telephone number is to be deleted. You hear 3 rising beeps as confirmation.

When a **CTM-A241P/CTM-A242P** is registered to a **CTM-A2411/CTM-A2411-BATT/CTM-A2421/CTM-A2421-BATT/CTM-A2510/CTM-A2510-USB** telephone base, you can program these keys using the telephone base or share the same Speed Dial numbers with the telephone base.

#### To enable the Speed Dial number sharing from the telephone base:

1. Remove the faceplate and overlay if they are on the telephone base. Then press the recessed **PROGRAM** key.
2. Press **03** and you hear 3 beeps. Then press **1** to enable. You hear 3 rising beeps as confirmation.

If you program a different set of Speed Dial numbers to the accessory Petite, you must disable the Speed Dial number sharing before you can program the Speed Dial numbers.

#### To disable the Speed Dial number sharing from the telephone base:

1. Remove the faceplate and overlay if they are on the telephone base. Then press the recessed **PROGRAM** key.
2. Press **03** and you hear 3 beeps. Then press **0** to disable. You hear 3 rising beeps as confirmation.

#### To program a Speed Dial key on a CTM-A241P/CTM-A242P cordless accessory Petite using the telephone base:

1. Remove the faceplate and overlay if they are on the telephone base. Then press the recessed **PROGRAM** key.
2. Press **70-79** or **7\*** for the desired Speed Dial key where the telephone number is to be stored and you hear 3 beeps.
3. Enter the telephone number (up to 32 digits).
  - To insert a pause in the stored number, press the recessed **PAUSE** key.
4. The telephone stores the number automatically when 32 digits are entered. When the number has less than 32 digits, press the recessed **PROGRAM** key again. You hear 3 rising beeps as confirmation.

#### To clear the programmed Speed Dial key using the telephone base:

1. Remove the faceplate and overlay if they are on the telephone base. Then press the recessed **PROGRAM** key.
2. Press **70-79**, or **7\*** for the desired Speed Dial key where the telephone number is to be deleted and you hear 3 beeps.
3. Press the recessed **PROGRAM** key again. You hear 3 rising beeps as confirmation.

# Telephone operation

## Analog corded lobby - A2100

### Receive a call

The telephone rings when there is an incoming call. Lift the corded handset from the telephone base to answer.

### Place a call

Lift the corded handset and it automatically connects to the operator. Refer to your PABX user's manual for automatic dialing.

### End a call

Place the corded handset in the telephone base.

### Volume

Listening volume and ringer volume can be adjusted from the telephone base.

#### To adjust the listening volume:

During a call, press **+VOLUME** or **-VOLUME** to adjust the listening volume. The next call returns to the default listening volume.

#### To adjust the ringer volume:

At any time, slide the **RINGER VOL** switch on the right side of the telephone base to adjust the ringer volume.

### Data port

You can connect your modem or fax machine to the telephone line through the **DATA** port.

# Telephone operation

## Analog corded 1-line - A2210

### Using the corded handset and the telephone base

The corded handset and the telephone base speakerphone cannot be used at the same time. However, calls can be switched between the corded handset and the telephone base speakerphone.

### Receive a call

When there is an incoming call, the telephone rings and the **MESSAGE WAITING** LED flashes.

#### To answer a call using the corded handset:

Lift the corded handset from the telephone base.

#### To answer a call using the telephone base:

On the telephone base, press **◀/SPEAKER**. The **◀/SPEAKER** key illuminates when in speakerphone mode.

### Place a call

Lift the corded handset or press **▶/SPEAKER** on the telephone base. Listen for a dial tone and then dial the desired number, or press a Speed Dial key to dial a programmed number. The **▶/SPEAKER** key illuminates when in speakerphone mode.

### End a call

Place the corded handset in the telephone base, or press **▶/SPEAKER** when in speakerphone mode.

### Switch a call between the corded handset and the telephone base speakerphone

- To switch a call from the corded handset to the telephone base speakerphone, press **▶/SPEAKER** on the telephone base, then place the corded handset on the telephone base cradle.
- To switch a call from the telephone base speakerphone to the corded handset currently on the telephone base cradle, lift the corded handset from the telephone base cradle.
- To switch a call from the telephone base speakerphone to the corded handset which is not on the telephone base cradle, press **▶/SPEAKER** on the telephone base.

### Share a call

During a call, parallel telephones (telephones on the same line) can join the call.

#### To join a call:

During a call, lift the corded handset or press **▶/SPEAKER** to join.

### Volume

Listening volume and ringer volume can be adjusted from the telephone base.

#### To adjust the listening volume:

During a call, press **+/VOLUME** or **-/VOLUME** to adjust the listening volume. The next call returns to the default listening volume.

#### To adjust the ringer volume:

At any time, slide the **RINGER VOL** switch on the right side of the telephone base to adjust the ringer volume.

### Call waiting

1. When you hear a call waiting tone during a call, press **FLASH** on the telephone base to put your current call on hold and take the new incoming call.
2. Press **FLASH** or the switch hook once rapidly at any time to switch back and forth between calls.

### Mute

#### To mute the microphone:

1. During a call, press **MUTE** on the telephone base. The **MUTE** key illuminates when the mute function is turned on. You can hear the party on the other end but they cannot hear you.
2. Press **MUTE** again to resume the conversation. The light on the **MUTE** key turns off.

# Telephone operation

## Analog corded 1-line - A2210

### Hold

When a call is placed on hold, any parallel phone that tries to use the same phone line will take the call off hold and pick the call.

### To place a call on hold:

1. During a call, press **HOLD** on the telephone base to place that call on hold. The **HOLD** key flashes when the call is placed on hold.
2. To release the call from hold, press **⏸/SPEAKER, HOLD** or lift the handset from the telephone base cradle.

### Data port

You can connect your modem or fax machine to the telephone line through the **DATA** port.

# Telephone operation

## Analog corded 2-line - A2220

### Using the corded handset and the telephone base

The corded handset and the telephone base speakerphone cannot be used at the same time. However, calls can be switched between the corded handset and the telephone base speakerphone.

**NOTE:** Make sure **LINE 1** is connected to maintain normal telephone operation.

### Receive a call

- When there is a line 1 incoming call, the telephone rings. The **MESSAGE WAITING** LED and **LINE 1** key flash.
- When there is a line 2 incoming call, the telephone rings. **LINE 2** key flashes.

### To answer a call using the corded handset:

Lift the cordless handset. It automatically connects to the ringing line. The respective line key illuminates when in use.

### To answer a call using the telephone base:

Press the flashing line key for the ringing line, or press **☎/SPEAKER**. It automatically connects to the ringing line. The respective line key and the **☎/SPEAKER** key illuminate when in use.

### Place a call

Lift the corded handset, or press **LINE 1**, **LINE 2**, or **☎/SPEAKER** on the telephone base. Listen for a dial tone and then dial the desired number, or press a Speed Dial key to dial a programmed number. The respective line key illuminates when in use. The **☎/SPEAKER** key illuminates when in speakerphone mode.

### End a call

Place the corded handset in the telephone base, or press **☎/SPEAKER** or the active line key when in speakerphone mode.

### Switch a call between the corded handset and the telephone base speakerphone

- To switch a call from the corded handset to the telephone base speakerphone, press **☎/SPEAKER** on the telephone base, then place the corded handset on the telephone base cradle. The active line is selected. When both lines are in use or on hold, **LINE 1** is selected.
- To switch a call from the telephone base speakerphone to the corded handset currently on the telephone base cradle, lift the corded handset from the telephone base cradle. The active line is selected. When both lines are in use or on hold, **LINE 1** is selected.
- To switch a call from the telephone base speakerphone to the corded handset which is not on the telephone base cradle, press **☎/SPEAKER** on the telephone base. The active line is selected. When both lines are in use or on hold, **LINE 1** is selected.

### Share a call

During a call, parallel telephones (telephones on the same line) can join the call.

### To join a call:

During a call on line 1 or line 2, press the respective **LINE 1** or **LINE 2** key to join.

### Speakerphone

- When the telephone is idle, press **☎/SPEAKER**. The first available line is selected, starting with line 1.
- During a call on the handset, press **☎/SPEAKER**. The active line is selected. When both lines are in use or on hold, **LINE 1** is selected.

### Volume

Listening volume and ringer volume can be adjusted from the telephone base.

### To adjust the listening volume:

During a call, press **+/VOLUME** or **-/VOLUME** to adjust the listening volume. The next call returns to the default listening volume.

### To adjust the ringer volume:

At any time, slide the **RINGER VOL** switch on the right side of the telephone base to adjust the ringer volume.

### Call waiting

1. When you hear a call waiting tone during a call, press **FLASH** on the telephone base to put your current call on hold and take the new incoming call.
2. Press **FLASH** or the switch hook once rapidly at any time to switch back and forth between calls.

# Telephone operation

## Analog corded 2-line - A2220

### Mute

#### To mute the microphone:

1. During a call, press **MUTE** on the telephone base. The **MUTE** key illuminates when the mute function is turned on. You can hear the party on the other end but they cannot hear you.
2. Press **MUTE** again to resume the conversation. The light on the **MUTE** key turns off.

### Hold

When a call is placed on hold, any parallel phone that tries to use the same phone line will take the call off hold and pick the call.

#### To place a call on hold:

1. During a call, press **HOLD** on the telephone base to place that call on hold. The respective line key flashes when the call is placed on hold.
2. Press the flashing line key or **◀▶/SPEAKER** to release the call from hold. The respective line key illuminates when in use. When both lines are on hold, press **◀▶/SPEAKER** releases the call on line 1.

### Conference call

This telephone allows three-way conversations.

#### To initiate a conference call:

1. Place a call to the first party.
2. Press **HOLD** to place the first party on hold.
3. Place a second call on the other line.
4. Once the second party is on the line, press **CONF** to start a three-way conference.

#### To initiate a conference call while both calls are on hold:

Press **CONF** to start a three-way conference.

#### To end a conference call:

- Press a line key to maintain the connection with that line and drop the other line.
- When the conference call is in speakerphone mode, press **CONF** or **◀▶/SPEAKER** on the telephone base to end.
- When the conference call is in handset earpiece mode, place the corded handset back in the telephone base to end.
- When there is more than one telephone on the conference call, the call ends when all telephones hang up.

### Data port

You can connect your modem or fax machine to the telephone line through the **DATA** port. The data port routes to line 2.

# Telephone operation

## Analog corded trimstyle - A2310

### Receive a call

When there is an incoming call, the telephone rings and the **MESSAGE WAITING** LED flashes.

#### To answer a call:

Lift the corded handset from the telephone base.

### Place a call

Lift the corded handset from the telephone base. Listen for a dial tone and then dial the desired number.

### End a call

Place the corded handset in the telephone base.

### Share a call

During a call, parallel telephones (telephones on the same line) can join the call. If the parallel telephone is a 2-line model, this telephone can only share call on one of the lines.

#### To join a call:

During a call, lift the corded handset to join.

### Volume

Listening volume and ringer volume can be adjusted.

#### To adjust the listening volume:

During a call, press **-/VOLUME/+** to adjust the listening volume. The next call returns to the default listening volume.

#### To adjust the ringer volume:

At any time, slide the **RINGER VOL** switch on the right side of the telephone base to adjust the ringer volume.

### Call waiting

1. When you hear a call waiting tone during a call, press **FLASH** on the handset to put your current call on hold and take the new incoming call.
2. Press **FLASH** or the switch hook once rapidly at any time to switch back and forth between calls.

### Mute

#### To mute the microphone:

1. During a call, press **MUTE** on the handset. The **MUTE** LED flashes when the mute function is turned on. You can hear the party on the other end but they cannot hear you.
2. Press any key to resume the conversation. The **MUTE** LED turns off.

### Data port

You can connect your modem or fax machine to the telephone line through the **FAX/DATA** port.



# Telephone operation

## Analog cordless 1-line - A2410/CTM-A2411/CTM-A2411-BATT

### Using the cordless handset and the telephone base

The cordless handset and the telephone base cannot be used on the same call. However, calls can be switched between the cordless handset and the telephone base speakerphone.

When the cordless handset or the telephone base is in use, the **TALK** key on the cordless handset and the **IN USE** LED on the telephone base illuminate.

### Receive a call

When there is an incoming call, the telephone rings. The **IN USE** LED and the **MESSAGE WAITING** LED on the telephone base flash, and the **TALK** key on the cordless handset flashes.

#### To answer a call using the cordless handset while it is not on the telephone base, charging base or charging stand:

On the cordless handset, press **TALK** or **◀/SPEAKER**. The **TALK** key illuminates when in use. The **◀/SPEAKER** key illuminates when in speakerphone mode.

#### To answer a call using the cordless handset while it is resting on the telephone base, charging base or charging stand:

Lift the cordless handset from the telephone base, charging base or charging stand. The **TALK** key illuminates when in use. The **◀/SPEAKER** key illuminates when in speakerphone mode.

#### To answer a call using the telephone base:

On the telephone base, press **◀/SPEAKER**. The **IN USE** LED and the **◀/SPEAKER** key illuminate when in use.

### Place a call

#### To place a call using the A2410 cordless handset:

On the cordless handset, press **TALK** or **◀/SPEAKER**. Listen for a dial tone and then dial the desired number, or press a Speed Dial key on the telephone base to dial a programmed number. The **TALK** key illuminates when in use. The **◀/SPEAKER** key illuminates when in speakerphone mode.

#### To place a call using the CTM-A2411/CTM-A2411-BATT cordless handset:

On the cordless handset, press **TALK** or **◀/SPEAKER**. Listen for a dial tone and then dial the desired number, or press a Speed Dial key on the telephone base or cordless handset to dial a programmed number. The **TALK** key illuminates when in use. The **◀/SPEAKER** key illuminates when in speakerphone mode.

#### To place a call using the telephone base:

On the telephone base, press **◀/SPEAKER**. Listen for a dial tone and then dial the desired number, or press a Speed Dial key to dial a programmed number. The **IN USE** LED and the **◀/SPEAKER** key illuminate when in use.

### End a call

#### To end a call when using the cordless handset:

Press **OFF** on the cordless handset or place it in the telephone base, charging base or charging stand. The call ends when all handsets hang up.

#### To end a call when using the telephone base:

Press **◀/SPEAKER**.

### Switch a call between the cordless handset and the telephone base speakerphone

- To switch a call from the cordless handset to the telephone base speakerphone, press **◀/SPEAKER** on the telephone base.
- To switch a call from the telephone base speakerphone to the cordless handset which is not on the telephone base cradle, press **TALK** or **◀/SPEAKER** on the cordless handset.
- To switch a call from the telephone base speakerphone to the cordless handset currently on the telephone base cradle, lift the cordless handset from the telephone base.

### Share a call

A maximum of four cordless handsets or accessory Petites can be used at the same time on an external call.

#### To join a call:

During a call, press **TALK** or **◀/SPEAKER** on another cordless handset to join.

# Telephone operation

## Analog cordless 1-line - A2410/CTM-A2411/CTM-A2411-BATT

### Handset speakerphone

During a call, press **Ⓜ/SPEAKER** on the cordless handset to switch between speakerphone mode and handset earpiece mode.

### Redial

The last dialed number on the cordless handset or the telephone base is stored for 15 minutes.

#### To redial the last dialed number from the cordless handset:

Press **TALK** or **Ⓜ/SPEAKER**. Listen for a dial tone. Then press **REDIAL**.

#### To redial the last dialed number from the telephone base:

Press **Ⓜ/SPEAKER**. Listen for a dial tone. Then press **REDIAL**.

### Volume

Listening volume can be adjusted on the cordless handset and the telephone base.

#### To adjust the listening volume:

- During a call on the handset, press **-/VOLUME/+** on it to adjust the listening volume. The next call returns to the default listening volume.
- During a call on the telephone base, press **+/VOLUME** or **-/VOLUME** on it to adjust the listening volume. The next call returns to the default listening volume.

Ringer volume of the telephone base can be adjusted.

#### To adjust the ringer volume of the telephone base:

When the telephone base is idle, press **+/VOLUME** or **-/VOLUME** on it to adjust the ringer volume.

### Call waiting

1. When you hear a call waiting tone during a call, press **FLASH** on the cordless handset or telephone base to put the current call on hold and take the new incoming call.
2. Press **FLASH** at any time to switch back and forth between calls.

### Mute

#### To mute the microphone:

1. During a call, press **MUTE** on the cordless handset or telephone base. The **MUTE** key illuminates when the mute function is turned on. You can hear the party on the other end but they cannot hear you.
2. Press **MUTE** again to resume the conversation. The light on the **MUTE** key turns off.

### Hold

When a call is placed on hold, any parallel phone that tries to use the same phone line will take the call off hold and pick the call.

#### To place a call on hold on the cordless handset:

1. During a call, press **HOLD** on the cordless handset. The **TALK** key on the cordless handset and the **HOLD** key on the telephone base flash when the call is on hold.
2. Press **TALK** or **Ⓜ/SPEAKER** to release the call from hold, or the call will end automatically after the preset call on hold duration.

#### To place a call on hold on the telephone base:

1. During a call, press **HOLD** on the telephone base. The **HOLD** key flashes when the call is on hold.
2. Press **Ⓜ/SPEAKER** to release the call from hold, or the call will end automatically after the preset call on hold duration.

# Telephone operation

## Analog cordless 1-line - A2410/CTM-A2411/CTM-A2411-BATT

### Intercom (for A2410 only)

Use this feature for conversations between two cordless handsets, or a cordless handset and the telephone base.

#### To initiate an intercom call:

- On the cordless handset, press **INTERCOM** when it is not in use. It beeps and the **INTERCOM** key illuminates. All destination cordless handsets (except the cordless handset on the telephone base) and the telephone base ring, and the **INTERCOM/INT** keys flash.

**-OR-**

- On the telephone base, press **INT** when it is not in use. It beeps and the **INT** key illuminates. All destination cordless handsets (except the cordless handset on the telephone base) ring and the **INTERCOM** keys flash.

#### To initiate an intercom call during a call:

- During a call on the cordless handset, press **HOLD** to put the current call on hold. Then press **INTERCOM**. It beeps and the **INTERCOM** key illuminates. All destination cordless handsets (except the cordless handset on the telephone base) and the telephone base ring, and the **INTERCOM/INT** keys flash.

**-OR-**

- During a call on the telephone base, press **HOLD** to put the current call on hold. Then press **INT**. It beeps and the **INT** key illuminates. All destination cordless handsets (except the cordless handset on the telephone base) ring and the **INTERCOM** keys flash.

#### To answer an intercom call:

- Lift the cordless handset from the telephone base cradle, or press **INTERCOM** or **📞/SPEAKER** on the cordless handset.

**-OR-**

- Press **INT** or **📞/SPEAKER** on the telephone base.

#### To answer an incoming call during an intercom call:

Press **TALK** on the cordless handset or press **📞/SPEAKER** twice on the telephone base. The intercom call ends automatically.

#### To end an intercom call:

- Place the cordless handset in the telephone base cradle, or press **OFF** on the cordless handset.

**-OR-**

- Press **INT** or **📞/SPEAKER** on the telephone base.

### Find handset

Use this feature to find all registered cordless handsets.

#### To start paging:

Press **📞/FIND HANDSET** on the telephone base when the telephone is not in use. All idle cordless handsets beep for 60 seconds.

#### To end paging:

- Press **📞/FIND HANDSET** again on the telephone base.

**-OR-**

- Press any key on the cordless handset to stop the paging tone.

### Data port

You can connect your modem or fax machine to the telephone line through the **DATA** port.

# Telephone operation

## Analog cordless 1-line accessory Petite - CTM-A241P

### Receive a call

When there is an incoming call, the telephone rings. The **IN USE** LED flashes.

#### To answer a call:

Lift the corded handset from the accessory phone base. The **IN USE** LED illuminates.

### Place a call

Lift the corded handset. Listen for a dial tone and then dial the desired number, or press a Speed Dial key to dial a programmed number. The **IN USE** LED illuminates.

### End a call

Place the corded handset back to the phone cradle.

### Switch a call between the accessory Petite and the telephone base speakerphone

- To switch a call from the accessory Petite to the telephone base speakerphone, press **◀/SPEAKER** on the telephone base.
- To switch a call from the telephone base speakerphone to the accessory Petite, lift the corded handset from the accessory phone base.

### Share a call

A maximum of four cordless handsets or accessory Petite phones can be used at the same time on an external call.

#### To join a call:

During a call, lift the corded handset to join.

### Volume

Listening volume and ringer volume can be adjusted from the accessory phone base.

#### To adjust the listening volume:

During a call, press **+VOLUME** or **-VOLUME** to adjust the listening volume. The next call returns to the default listening volume.

#### To adjust the ringer volume:

At any time, slide the **RINGER VOL** switch on the right side of the accessory phone base to adjust the ringer volume.

### Call waiting

1. When you hear a call waiting tone during a call, press **FLASH** on the accessory phone base to put your current call on hold and take the new incoming call.
2. Press **FLASH** or the switch hook once rapidly at any time to switch back and forth between calls.

### Mute

#### To mute the microphone:

1. During a call, press **MUTE** on the accessory Petite. The **MUTE** key illuminates when the mute function is turned on. You can hear the party on the other end but they cannot hear you.
2. Press **MUTE** again to resume the conversation. The light on the **MUTE** key turns off.

### Hold

When a call is placed on hold, any parallel phone that tries to use the same phone line will take the call off hold and pick the call.

#### To place a call on hold:

1. During a call, press **HOLD** on the accessory Petite to place that call on hold. The **IN USE** LED flashes when the call is placed on hold.
2. To release the call from hold, press the switch hook once rapidly.

### USB port

The  port on the side of the accessory Petite can be used for charging devices (up to 1A @ 5.1V).

# Telephone operation

## Analog cordless 2-line - A2420/CTM-A2421/CTM-A2421-BATT

### Using the cordless handset and the telephone base

The cordless handset and the telephone base cannot be used on the same call. However, calls can be switched between the cordless handset and the telephone base speakerphone.

When the cordless handset or the telephone base is in use, the corresponding line keys on the cordless handset and the telephone base illuminate.

### Receive a call

When there is an incoming call, the telephone rings. The corresponding line key and the **MESSAGE WAITING** LED on the telephone base flash, and the corresponding line key on the cordless handset flashes.

#### To answer a call using the cordless handset while it is not on the telephone base, charging base or charging stand:

On the cordless handset, press the flashing line key for the ringing line, or press **☎/SPEAKER**. It automatically connects to the ringing line. The respective line key illuminates when in use. The **☎/SPEAKER** key illuminates when in speakerphone mode.

#### To answer a call using the cordless handset while it is resting on the telephone base, charging base or charging stand:

Pick up the cordless handset from the telephone base. It automatically connects to the ringing line. The respective line key illuminates when in use.

#### To answer a call using the telephone base:

On the telephone base, press the flashing line key for the ringing line, or press **☎/SPEAKER**. It automatically connects to the ringing line. The respective line key and the **☎/SPEAKER** key illuminate when in use.

### Place a call

#### To place a call using the A2420 cordless handset:

On the cordless handset, press **LINE 1**, **LINE 2** or **☎/SPEAKER**. Listen for a dial tone and then dial the desired number, or press a Speed Dial key on the telephone base to dial a programmed number. The line key illuminates when in use. The **☎/SPEAKER** key illuminates when in speakerphone mode.

#### To place a call using the CTM-A2421/CTM-A2421-BATT cordless handset:

On the cordless handset, press **LINE 1**, **LINE 2** or **☎/SPEAKER**. Listen for a dial tone and then dial the desired number, or press a Speed Dial key on the telephone base or cordless handset to dial a programmed number. The line key illuminates when in use. The **☎/SPEAKER** key illuminates when in speakerphone mode.

#### To place a call using the telephone base:

On the telephone base, press **LINE 1**, **LINE 2** or **☎/SPEAKER**. Listen for a dial tone and then dial the desired number, or press a Speed Dial key to dial a programmed number. The line key and the **☎/SPEAKER** key illuminate when in use.

### End a call

#### To end a call when using the cordless handset:

Press **OFF** on the cordless handset or place it in the telephone base, charging base or charging stand. The call ends when all handsets hang up.

#### To end a call when using the telephone base:

Press **☎/SPEAKER** or the respective line key on the telephone base.

### Switch a call between the cordless handset and the telephone base speakerphone

- To switch a call from the cordless handset to the telephone base speakerphone, press the respective line key or **☎/SPEAKER** on the telephone base.
- To switch a call from the telephone base speakerphone to the cordless handset which is not on the telephone base cradle, press the respective line key or **☎/SPEAKER** on the cordless handset.
- To switch a call from the telephone base speakerphone to the cordless handset currently on the telephone base cradle, lift the cordless handset from the telephone base.

### Share a call

A maximum of four cordless handsets or accessory Petite phones can be used at the same time on an external call. If both lines are in use, a maximum of three cordless handsets or accessory Petite phones can be used on one line and the fourth handset or accessory Petite phone can be used on the other line at the same time.

#### To join a call:

During a call on line 1 or line 2, press the respective **LINE 1**, **LINE 2** or **☎/SPEAKER** on another cordless handset to join.

### Handset speakerphone

During a call on the handset, press **☎/SPEAKER** on the cordless handset to switch between speakerphone mode and handset earpiece mode.

# Telephone operation

## Analog cordless 2-line - A2420/CTM-A2421/CTM-A2421-BATT

### Speakerphone

When the telephone is idle, press **☎/SPEAKER** on the cordless handset or the telephone base. The first available line is selected, starting with line 1.

### Redial

The last dialed number on the cordless handset or telephone base is stored for 15 minutes.

#### To redial the last dialed number from the handset or telephone base:

Press **LINE 1**, **LINE 2** or **☎/SPEAKER**. Listen for a dial tone. Then press **REDIAL**.

### Volume

Listening volume can be adjusted on the cordless handset and the telephone base.

#### To adjust the listening volume:

- During a call on the handset, press **-/VOLUME/+** on it to adjust the listening volume. The next call returns to the default listening volume.
- During a call on the telephone base, press **+/VOLUME** or **-/VOLUME** on it to adjust the listening volume. The next call returns to the default listening volume.

Ringer volume of the telephone base can be adjusted.

#### To adjust the ringer volume of the telephone base:

When the telephone base is idle, press **+/VOLUME** or **-/VOLUME** on it to adjust the ringer volume.

### Call waiting

1. When you hear a call waiting tone during a call, press **FLASH** on the cordless handset or telephone base to put the current call on hold and take the new incoming call.
2. Press **FLASH** at any time to switch back and forth between calls.

### Mute

#### To mute the microphone:

1. During a call, press **MUTE** on the cordless handset or telephone base. The **MUTE** key illuminates when the mute function is turned on. You can hear the party on the other end but they cannot hear you.
2. Press **MUTE** again to resume the conversation. The light on the **MUTE** key turns off.

### Hold

When a call is placed on hold, any parallel phone that tries to use the same phone line will take the call off hold and pick the call.

#### To place a call on hold:

1. During a call, press **HOLD** on the cordless handset or telephone base to place that call on hold. The corresponding line key flashes when the call is on hold.
2. Press the flashing line key or **☎/SPEAKER** to release the call from hold, or the call will end automatically after the preset call on hold duration. When both lines are on hold, press **☎/SPEAKER** releases the call on line 1.

### Intercom (for A2420 only)

#### To initiate an intercom call:

- On the cordless handset, press **INTERCOM** when it is not in use. It beeps and the **INTERCOM** key illuminates. All destination cordless handsets (except the cordless handset on the telephone base) and the telephone base ring, and the **INTERCOM/INT** keys flash.

**-OR-**

- On the telephone base, press **INT** when it is not in use. It beeps and the **INT** key illuminates. All destination cordless handsets (except the cordless handset on the telephone base) ring and the **INTERCOM** keys flash.

#### To initiate an intercom call during a call:

- During a call on the cordless handset, press **HOLD** to put the current call on hold. Then press **INTERCOM**. It beeps and the **INTERCOM** key illuminates. All destination cordless handsets (except the cordless handset on the telephone base) and the telephone base ring, and the **INTERCOM/INT** keys flash.

**-OR-**

- During a call on the telephone base, press **HOLD** to put the current call on hold. Then press **INT**. It beeps and the **INT** key illuminates. All destination cordless handsets (except the cordless handset on the telephone base) ring and the **INTERCOM** keys flash.

# Telephone operation

## Analog cordless 2-line - A2420/CTM-A2421/CTM-A2421-BATT

### To answer an intercom call:

- Lift the cordless handset from the telephone base cradle, or press **INTERCOM** on the cordless handset.

**-OR-**

- Press **INT** or **📞/SPEAKER** on the telephone base.

### To answer an incoming call during an intercom call:

Press the flashing line key on the cordless handset or telephone base, or press **📞/SPEAKER** twice on the telephone base. The intercom call ends automatically.

### To end an intercom call:

- Place the cordless handset on the telephone base cradle, or press **OFF** on the cordless handset.

**-OR-**

- Press **INT** on the telephone base.

## Conference call

This telephone allows three-way conversations.

### To initiate a conference call:

1. Place a call to the first party.
2. Press **HOLD** to place the first party on hold.
3. Place a second call on the other line.
4. Once the second party is on the line, press **CONF** to start a three-way conference.

### To initiate a conference call while both calls are on hold:

Press **CONF** to start a three-way conference.

### To switch a conference call from the telephone base to the cordless handset:

- During a conference call on the telephone base, press **📞/SPEAKER** or **CONF** on the cordless handset, or lift the cordless handset from the telephone base.
- During a conference call on the telephone base, press **HOLD** on the telephone base and then press **CONF** on the cordless handset.

### To switch a conference call from the cordless handset to the telephone base:

- During a conference call on the cordless handset, press **📞/SPEAKER** or **CONF** on the telephone base.
- During a conference call on the cordless handset, press **HOLD** on the cordless handset and then press **CONF** on the telephone base.

### To end a conference call:

- Press a line key to maintain the connection with that line and drop the other line.
- When the conference call is at the telephone base, press **📞/SPEAKER** or **CONF** on the telephone base.
- When the conference call is on the cordless handset, press **OFF** on the cordless handset, or place it back in the telephone base, charging base or charging stand.
- When there is more than one cordless handset on the conference call, the call ends when all handsets hang up.

## Find handset

Use this feature to find all registered cordless handsets.

### To start paging:

Press **📞/FIND HANDSET** on the telephone base when the telephone is not in use. All idle cordless handsets beep for 60 seconds.

### To end paging:

- Press **📞/FIND HANDSET** again on the telephone base.

**-OR-**

- Press any key on the handset to stop the paging tone.

## Data port

You can connect your modem or fax machine to the telephone line through the **DATA** port. The data port routes to line 2.

# Telephone operation

## Analog cordless 2-line accessory Petite - CTM-A242P

### Receive a call

- When there is a line 1 incoming call, the telephone rings. The **LINE 1** key flashes.
- When there is a line 2 incoming call, the telephone rings. The **LINE 2** key flashes.

### To answer a call:

Lift the corded handset. It automatically connects to the ringing line. The respective line key illuminates when in use.

### Place a call

Lift the corded handset then press **LINE 1** or **LINE 2**. Listen for a dial tone and then dial the desired number, or press a Speed Dial key to dial a programmed number. The respective line key illuminates when in use.

### End a call

Place the corded handset back to the phone cradle.

### Switch a call between the accessory Petite and the telephone base speakerphone

- To switch a call from the accessory Petite to the telephone base speakerphone, press **☎/SPEAKER** on the telephone base.
- To switch a call from the telephone base speakerphone to the accessory Petite, lift the corded handset from the accessory phone base.

### Share a call

A maximum of four cordless handsets or accessory Petite phones can be used at the same time on an external call.

### To join a call:

During a call on line 1 or line 2, press the respective **LINE 1** or **LINE 2** key to join.

### Volume

Listening volume and ringer volume can be adjusted from the accessory phone base.

### To adjust the listening volume:

During a call, press **+/VOLUME** or **-/VOLUME** to adjust the listening volume. The next call returns to the default listening volume.

### To adjust the ringer volume:

At any time, slide the **RINGER VOL** switch on the right side of the accessory Petite to adjust the ringer volume.

### Call waiting

1. When you hear a call waiting tone during a call, press **FLASH** on the accessory Petite to put your current call on hold and take the new incoming call.
2. Press **FLASH** or the switch hook once rapidly at any time to switch back and forth between calls.

### Mute

#### To mute the microphone:

1. During a call, press **MUTE** on the accessory Petite. The **MUTE** key illuminates when the mute function is turned on. You can hear the party on the other end but they cannot hear you.
2. Press **MUTE** again to resume the conversation. The light on the **MUTE** key turns off.

### Hold

When a call is placed on hold, any parallel phone that tries to use the same phone line will take the call off hold and pick the call.

#### To place a call on hold:

1. During a call, press **HOLD** on the accessory Petite to place that call on hold. The respective line key flashes when the call is placed on hold.
2. Press the flashing line key to release the call from hold. The respective line key illuminates when in use.



# Telephone operation

## Analog cordless 2-line accessory Petite- CTM-A242P

### Conference call

This telephone allows three-way conversations.

#### To initiate a conference call:

1. Place a call to the first party.
2. Press **HOLD** to place the first party on hold.
3. Place a second call on the other line.
4. Once the second party is on the line, press **CONF** to start a three-way conference.

#### To initiate a conference call while both calls are on hold:

Press **CONF** to start a three-way conference.

#### To end a conference call:

- Press a line key to maintain the connection with that line and drop the other line.
- Place the corded handset back in the accessory phone base to end.
- When there is more than one phone devices on the conference call, the call ends when all phone devices hang up.

### USB port

The  port on the side of the accessory phone base can be used for charging devices (up to 1A @ 5.1V).

# Telephone operation

## Analog corded/cordless 1-line - CTM-A2510/CTM-A2510-USB

### Using the corded handset, cordless handset and the telephone base

The corded handset, cordless handset and the telephone base cannot be used on the same call. However, calls can be switched among the corded handset, cordless handset and the telephone base speakerphone.

When the corded handset, cordless handset or the telephone base is in use, the **TALK** key on the cordless handset and the **IN USE LED** on the telephone base illuminate.

### Receive a call

When there is an incoming call, the telephone rings. The **IN USE LED** and the **MESSAGE WAITING LED** on the telephone base flash, and the **TALK** key on the cordless handset flashes.

#### To answer a call using the corded handset:

Lift the corded handset from the telephone base. The **IN USE LED** on the telephone base illuminates.

#### To answer a call using the cordless handset while it is not on the charging base or charging stand:

On the cordless handset, press **TALK** or **☎/SPEAKER**. The **TALK** key illuminates when in use. The **☎/SPEAKER** key illuminates when in speakerphone mode.

#### To answer a call using the cordless handset while it is resting on the charging base or charging stand:

Lift the cordless handset from the charging base or charging stand. The **TALK** key illuminates when in use. The **☎/SPEAKER** key illuminates when in speakerphone mode.

#### To answer a call using the telephone base:

On the telephone base, press **☎/SPEAKER**. The **IN USE LED** and the **☎/SPEAKER** key illuminate when in use.

### Place a call

#### To place a call using the corded handset:

Lift the corded handset from the telephone base. Listen for a dial tone and then dial the desired number, or press a Speed Dial key on the telephone base or cordless handset to dial a programmed number. The **IN USE** key illuminates when in use.

#### To place a call using the cordless handset:

On the cordless handset, press **TALK** or **☎/SPEAKER**. Listen for a dial tone and then dial the desired number, or press a Speed Dial key on the telephone base or cordless handset to dial a programmed number. The **TALK** key illuminates when in use. The **☎/SPEAKER** key illuminates when in speakerphone mode.

#### To place a call using the telephone base:

On the telephone base, press **☎/SPEAKER**. Listen for a dial tone and then dial the desired number, or press a Speed Dial key to dial a programmed number. The **IN USE LED** and the **☎/SPEAKER** key illuminate when in use.

### End a call

#### To end a call when using the corded handset:

Place the corded handset in the telephone base. The call ends when all handsets hang up.

#### To end a call when using the cordless handset:

Press **OFF** on the cordless handset or place it in the charging base or charging stand. The call ends when all handsets hang up.

#### To end a call when using the telephone base:

Press **☎/SPEAKER**.

### Switch a call among the corded handset, cordless handset and the telephone base speakerphone

- To switch a call from the corded or cordless handset to the telephone base speakerphone, press **☎/SPEAKER** on the telephone base.
- To switch a call from the telephone base speakerphone to the cordless handset which is not on the charging base or charging stand, press **TALK** or **☎/SPEAKER** on the cordless handset.
- To switch a call from the telephone base speakerphone to the corded handset, lift the corded handset from the telephone base.

### Share a call

A maximum of four cordless handsets or accessory Petite phones can be used at the same time on an external call.

#### To join a call:

During a call, press **TALK** or **☎/SPEAKER** on another cordless handset to join.

# Telephone operation

## Analog corded/cordless 1-line - CTM-A2510/CTM-A2510-USB

### Handset speakerphone

During a call, press **Ⓜ/SPEAKER** on the cordless handset to switch between speakerphone mode and handset earpiece mode.

### Redial

The last dialed number on the cordless handset or the telephone base is stored for 15 minutes.

#### To redial the last dialed number from the corded handset:

Lift the corded handset from the telephone base. Listen for a dial tone. Then press **REDIAL**.

#### To redial the last dialed number from the cordless handset:

Press **TALK** or **Ⓜ/SPEAKER**. Listen for a dial tone. Then press **REDIAL**.

#### To redial the last dialed number from the telephone base:

Press **Ⓜ/SPEAKER**. Listen for a dial tone. Then press **REDIAL**.

### Volume

Listening volume can be adjusted on the cordless handset and the telephone base.

#### To adjust the listening volume:

- During a call on the handset, press **-/VOLUME/+** on it to adjust the listening volume. The next call returns to the default listening volume.
- During a call on the telephone base, press **+/VOLUME** or **-/VOLUME** on it to adjust the listening volume. The next call returns to the default listening volume.

Ringer volume of the telephone base can be adjusted.

#### To adjust the ringer volume of the telephone base:

When the telephone base is idle, press **+/VOLUME** or **-/VOLUME** on it to adjust the ringer volume.

### Call waiting

1. When you hear a call waiting tone during a call, press **FLASH** on the cordless handset or telephone base to put the current call on hold and take the new incoming call.
2. Press **FLASH** or the switch hook once rapidly at any time to switch back and forth between calls.

### Mute

#### To mute the microphone:

1. During a call, press **MUTE** on the cordless handset or telephone base. The **MUTE** key illuminates when the mute function is turned on. You can hear the party on the other end but they cannot hear you.
2. Press **MUTE** again to resume the conversation. The light on the **MUTE** key turns off.

### Hold

When a call is placed on hold, any parallel phone that tries to use the same phone line will take the call off hold and pick the call.

#### To place a call on hold on the cordless handset:

1. During a call, press **HOLD** on the cordless handset. The **TALK** key on the cordless handset and the **HOLD** key on the telephone base flash when the call is on hold.
2. Press **TALK** or **Ⓜ/SPEAKER** to release the call from hold, or the call will end automatically after the preset call on hold duration.

#### To place a call on hold on the telephone base:

1. During a call, press **HOLD** on the telephone base. The **HOLD** key flashes when the call is on hold.
2. Press **Ⓜ/SPEAKER** to release the call from hold, or the call will end automatically after the preset call on hold duration.

## Telephone operation

### Analog corded/cordless 1-line - CTM-A2510/CTM-A2510-USB

#### Find handset

Use this feature to find all registered cordless handsets.

#### To start paging:

Press **FIND HANDSET** on the telephone base when the telephone is not in use. All idle cordless handsets beep for 60 seconds.

#### To end paging:

- Press **FIND HANDSET** again on the telephone base.

**-OR-**

- Press any key on the cordless handset to stop the paging tone.

#### Data port

You can connect your modem or fax machine to the telephone line through the **DATA** port.

#### USB port (for CTM-A2510-USB only)

The  port on the side of the charging stand can be used for charging devices (up to 1A @ 5.1V).

# Appendix

## Handset battery

It takes up to 16 hours for the battery to be fully charged. When it is fully charged, you can expect the following performance:

Operation	Operating time
While in handset use (talking*)	Up to 7 hours
While in speakerphone mode (talking*)	Up to 5 hours
While not in use (standby**)	Up to 7 days

\* Operating times vary depending on your actual use and the age of the battery.

\*\* Handset is not charging or in use.

The battery needs charging when:

- A new battery is installed in the handset.
- **LOW BATTERY** LED flashes on the cordless handset.

### CAUTION:

To reduce the risk of fire or injury, read and follow these instructions:

- Use only the supplied rechargeable battery (BT264392/BT266342) or replacement battery (BT266342). To order a replacement, visit our website at [www.vtechhotelphones.com](http://www.vtechhotelphones.com) or contact your local distributor.
- Do not dispose of the battery in a fire. Check with local waste management codes for special disposal instructions.
- Do not open or mutilate the battery. Released electrolyte is corrosive and may cause burns or injury to the eyes or skin. The electrolyte may be toxic if swallowed.
- Exercise care in handling the battery in order not to create a short circuit with conductive materials.
- Charge the battery provided with or identified for use with this product only in accordance with the instructions and limitations specified in this manual.
- Observe proper polarity orientation between the battery and metallic contacts.
- To prevent fire or shock hazard, do not expose this product to water or any type of moisture.

# Appendix

## Troubleshooting

If you have difficulty with the telephones, please try the suggestions below. For customer service, visit our website at [www.vtechhotelphones.com](http://www.vtechhotelphones.com) or contact your local distributor.

### For corded telephones:

#### The telephone does not work at all.

- Make sure the telephone line is plugged into the **TEL** port of the telephone base.
- Make sure the telephone line cord is plugged firmly into the telephone wall jack.
- Disconnect the telephone base from the telephone wall jack and plug in a working telephone. If the other telephone does not work, the problem is probably in the wiring or telephone service. Contact your telephone service provider (charges may apply).

#### There is no dial tone.

- Try all the above suggestions.
- The telephone line cord may be defective. Install a new telephone line cord.
- Disconnect the telephone base from the telephone wall jack and connect a different telephone. If there is no dial tone on this telephone either, the problem is in your wiring or telephone service. Contact your telephone service provider (charges may apply).

#### I cannot dial out.

- Try all the above suggestions.
- Make sure there is a dial tone before dialing.
- Eliminate any background noise. Mute the telephone before dialing, if applicable, or dial from another room in your unit with less background noise.
- If other telephones in your hotel are having the same problem, the problem is in the wiring or telephone service. Contact your telephone service provider (charges may apply).

#### The telephone does not ring when there is an incoming call.

- Make sure the telephone line cord is plugged in properly (pages 28, 30 and 44).
- If other telephones in your hotel are having the same problem, the problem is in the wiring or telephone service. Contact your telephone service provider (charges may apply).
- Test a working telephone at the telephone wall jack. If another telephone has the same problem, the problem is in the telephone wall jack. Contact your telephone service provider (charges may apply).
- The telephone line cord may be defective. Install a new telephone line cord.

#### There is interference during a telephone conversation.

- If there is High Speed Internet Access (HSIA) available at the premises through a telephone line, you may need to install a DSL filter (DSL - digital subscriber line) between the telephone line cord and the telephone wall jack. The filter prevents noise and caller ID problems caused by DSL interference. Contact your DSL service provider for more information about DSL filters.
- If your telephone is plugged in with a modem or a surge protector, plug the telephone (or modem/surge protector) into a different location. If this doesn't solve the problem, relocate your telephone or modem farther apart from each other, or use a different surge protector.
- Disconnect the telephone base from the telephone wall jack. Plug in a different telephone. If calls are still not clear, the problem is probably in the wiring or local telephone service. Contact your telephone service provider (charges may apply).
- If other telephones in your hotel are having the same problem, the problem is in the wiring or telephone service. Contact your telephone service provider (charges may apply).

#### I hear other calls when using the telephone.

- Disconnect the telephone base from the telephone wall jack. Plug in a different telephone. If you still hear other calls, the problem is probably in the wiring or telephone service. Contact your telephone service provider (charges may apply).

# Appendix

## Troubleshooting

### For cordless telephones:

#### The telephone does not work at all.

- Make sure the RJ-45 cord is plugged into the **TEL** port of the telephone base.
- Make sure the power adapter is securely plugged into an outlet not controlled by a wall switch.
- Make sure the telephone line cord is plugged firmly into the power adapter and the telephone wall jack.
- Make sure the battery is installed and charged correctly (pages 37, 39 and 46). For optimum daily performance, return the cordless handset to the telephone base, charging base or charging stand after use.
- Unplug the electrical power to the telephone base. Wait for approximately 15 seconds, then plug it back in. Allow up to one minute for the cordless handset and telephone base to synchronize.
- Charge the battery in the cordless handset for up to 16 hours.
- If the battery is completely depleted, it may take up to 30 minutes to charge the cordless handset before the **LOW BATTERY LED** flashes on the cordless handset.
- Remove and install the battery again. If that still does not work, it may be necessary to purchase a new battery.
- Disconnect the telephone base from the telephone wall jack and plug in a working telephone. If the other telephone does not work, the problem is probably in the wiring or telephone service. Contact your telephone service provider (charges may apply).

#### There is no dial tone.

- Try all the above suggestions.
- Move the cordless handset closer to the telephone base or adjust the setting of RF transmission power (page 59). It may be out of range.
- The telephone line cord may be defective. Install a new telephone line cord.
- Disconnect the telephone base from the telephone wall jack and connect a different telephone. If there is no dial tone on this telephone either, the problem is in your wiring or telephone service. Contact your telephone service provider (charges may apply).

#### I cannot dial out.

- Try all the above suggestions.
- Make sure there is a dial tone before dialing. It is normal if the cordless handset takes a second or two to synchronize with the telephone base before producing a dial tone. Wait an extra second before dialing.
- Eliminate any background noise. Mute the telephone before dialing, or dial from another room in your unit with less background noise.
- If other telephones in your hotel are having the same problem, the problem is in the wiring or telephone service. Contact your telephone service provider (charges may apply).

#### The **LOW BATTERY LED** flashes on the cordless handset.

- Place the cordless handset in the telephone base, charging base or charging stand for recharging.
- Remove and install the battery again and use it until fully depleted, then charge the cordless handset in the telephone base, charging base or charging stand for up to 16 hours.
- If the above measures do not correct the problem, replace the battery.

#### The battery does not charge in the cordless handset or the battery does not accept charge.

- Make sure the cordless handset is placed in the telephone base, charging base or charging stand correctly. The **CHARGE LED** should be on.
- Remove and install the battery again, then charge for up to 16 hours.
- If the cordless handset is in the telephone base, charging base or charging stand but the **CHARGE LED** is not on, refer to **The CHARGE LED is off** below.
- If the battery is completely depleted, charge it for at least 30 minutes before use.
- If the above measures do not correct the problem, replace the battery.

#### The **CHARGE LED** is off.

- Clean the charging contacts on the cordless handset, telephone base, charging base and charging stand each month with a pencil eraser or a dry non-abrasive fabric.
- Make sure the power adapter and telephone line cord are plugged in correctly and securely.
- Unplug the power adapter. Wait for 15 seconds before plugging it back in. Allow up to one minute for the cordless handset and telephone base to reset.

# Appendix

## Troubleshooting

### For cordless telephones:

#### The telephone does not ring when there is an incoming call.

- Make sure the telephone line cord and the power adapter are plugged in properly (page 32).
- The cordless handset may be too far from the telephone base. Move it closer to the telephone base.
- Adjust the setting of RF transmission power (page 59). It may be out of range.
- If other telephones in your hotel are having the same problem, the problem is in the wiring or telephone service. Contact your telephone service provider (charges may apply).
- Other electronic products such as HAM radios and other DECT phones can cause interference with your cordless phone. Try installing your phone as far away as possible from these types of electronic devices.
- Test a working telephone at the telephone wall jack. If another telephone has the same problem, the problem is in the telephone wall jack. Contact your telephone service provider (charges may apply).
- The telephone line cord may be defective. Install a new telephone line cord.
- Remove and install the battery again and place the cordless handset in the telephone base. Wait for the handset to synchronize with the telephone base. Allow up to one minute for this to take place.

#### The cordless handset beeps and is not performing normally.

- Make sure the power cord is securely plugged into the telephone base. Plug the telephone base into a different working electrical outlet not controlled by a wall switch.
- Move the cordless handset closer to the telephone base or adjust the setting of RF transmission power (page 59). It may be out of range.
- Reset the telephone base by unplugging the electrical power to the base. Wait for 15 seconds and plug it back in again. Allow up to one minute for the cordless handset and the telephone base to synchronize.
- Other electronic products such as HAM radios and other DECT phones can cause interference with your cordless phone. Try installing your phone as far away as possible from these types of electronic devices.

#### There is interference during a telephone conversation or the call fades in and out when I am using the cordless handset.

- Move the handset closer to the telephone base or adjust the setting of RF transmission power (page 59). It may be out of range.
- If there is High Speed Internet Access (HSIA) available at the premises through a telephone line, you may need to install a DSL filter (DSL - digital subscriber line) between the telephone line cord and the telephone wall jack. The filter prevents noise and caller ID problems caused by DSL interference. Contact your DSL service provider for more information about DSL filters.
- Appliances or other cordless telephones plugged into the same circuit as the telephone base can cause interference. Try moving the appliance or telephone base to another outlet.
- Other electronic products such as HAM radios and other DECT phones can cause interference with your cordless phone. Try installing your phone as far away as possible from these types of electronic devices.
- If your telephone is plugged in with a modem or a surge protector, plug the telephone (or modem/surge protector) into a different location. If this doesn't solve the problem, relocate your telephone or modem farther apart from each other, or use a different surge protector.
- The location of your telephone base can impact the performance of your cordless phone. For better reception, install the telephone base in a centralized location within the room, away from walls or other obstructions.
- Disconnect the telephone base from the telephone wall jack and plug in a corded telephone. If calls are still not clear, the problem is probably in the wiring or telephone service. Contact your telephone service provider (charges may apply).
- If other telephones in your hotel are having the same problem, the problem is in the wiring or telephone service. Contact your telephone service provider (charges may apply).

#### I hear other calls when using the telephone.

- Disconnect the telephone base from the telephone wall jack. Plug in a different telephone. If you still hear other calls, the problem is probably in the wiring or telephone service. Contact your telephone service provider (charges may apply).

#### I hear noise on the cordless handset and the keys do not work.

- Make sure the telephone line cord is plugged in securely.

#### Common cure for electronic equipment.

- If the telephone is not responding normally, put the cordless handset in the telephone base. If it does not fix the problem, try the following (in the order listed):
  1. Disconnect the power to the telephone base.
  2. Disconnect the battery on the cordless handset.
  3. Wait a few minutes before connecting power to the telephone base.
  4. Install the battery again and place the cordless handset in the telephone base.
  5. Wait for the cordless handset to synchronize with the telephone base. Allow up to one minute for this to take place.



# Appendix

## VTech Hospitality limited warranty program

VTech Communications, Inc., the manufacturer of VTech Hospitality Product (“Product”), warrants to the holder of a valid proof of purchase (“end user” or “you”) that the Product and all accessories provided by VTech in the Product’s package are free from defects in material and workmanship, pursuant to the following terms and conditions, when installed and used normally and in accordance with the Product’s operating instructions. The limited warranty extends to the end user of this Product and applies only if such Product is purchased through an authorized distributor. The limited warranty period for this Product is determined based on the following:

### 5 Years – Analog Models

- All Classic Models – corded and cordless
- All Contemporary Models – corded and cordless
- All TrimStyle Models

### 2 Years – SIP Non-Display Models

- All Classic Models – corded and cordless
- All Contemporary Models – corded and cordless
- All TrimStyle Models

During the limited warranty period, VTech’s authorized service representative will repair or replace, at VTech’s option, without charge, a Product that is not free from defects in materials and workmanship. If VTech’s authorized service representative repairs the Product, new or refurbished replacement parts may be used. If the Product is replaced, it may be replaced with a new or refurbished Product of the same or similar design. Repair or replacement of Product, at VTech’s option, is the exclusive remedy.

The limited warranty period for the Product begins on the date that the end user takes possession of the Product. This limited warranty also applies to repaired or replacement Products for a period of either: (a) 90 days from the date the repaired or replacement Product is shipped to you; or (b) the time remaining on the original limited warranty as described above; whichever is longer.

This limited warranty does not cover:

1. Product or parts that have been subjected to misuse, accident, shipping or other physical damage, improper installation, abnormal operation or handling, neglect, inundation, fire, water or other liquid intrusion; or
2. Product that has been damaged due to repair, alteration or modification by anyone other than an authorized service representative of VTech; or
3. Product to the extent that the problem experienced is caused by signal conditions, network reliability or cable or antenna systems; or
4. Product to the extent that the problem is caused by use with non-VTech accessories; or
5. Product whose warranty/quality stickers, product serial number plates or electronic serial numbers have been removed, altered or rendered illegible; or
6. Product purchased, used, serviced, or shipped for repair from outside the United States or Canada, or used for non-approved commercial or institutional purposes (including but not limited to Products used for rental purposes); or
7. Product returned without valid proof of purchase; or
8. Charges or costs incurred by the end user, and risk of loss or damage, in removing and shipping the Product, or for installation or set up, adjustment of customer controls, and installation or repair of systems outside the unit.
9. Line cords or coil cords, plastic overlays, connectors, power adapters and batteries, if the Product is returned without them. VTech will charge the end user at then-current prices for each of the missing items.
10. NiCd or NiMH handset batteries, or power adapters, which, under all circumstances, are covered by a one (1) year warranty only.

Except as provided by applicable law, you assume the risk of loss or damage during transit and transportation and are responsible for delivery or handling charges incurred in the transport of Product(s) to the service location. VTech’s authorized service representative will return repaired or replaced product under this limited warranty to you. Transportation, delivery and handling charges are prepaid. VTech assumes no risk for damage or loss of the Product in transit.

If the Product failure is not covered by this limited warranty, or proof of purchase does not meet the terms of this limited warranty, VTech will notify you and will request that you authorize the cost of repair and return shipping costs for the repair of Products that not covered by this limited warranty. You must pay for the cost of repair and return shipping costs for the repair of Products that are not covered by this limited warranty.

### Other limitations

This warranty is the complete and exclusive agreement between you and VTech. It supersedes all other written or oral communications related to this Product. VTech provides no other warranties for this Product, whether express or implied, oral or written, or statutory. The warranty exclusively describes all of VTech’s responsibilities regarding the Product. No one is authorized to make modifications to this warranty and you should not rely on any such modification.

VTech’s liability to end user hereunder shall not exceed the purchase price of the Product. In no event shall VTech be liable for any indirect, special, incidental, consequential, or similar damages (including, but not limited to lost profits or revenue, inability to use the product, or other associated equipment, the cost of substitute equipment, and claims by third parties) resulting from the use of this Product. Some states/provinces do not allow the exclusion or limitation of incidental or consequential damages, so the above limitation or exclusion may not apply to you.

This warranty gives you specific legal rights, and you also have other rights which vary from state to state or province to province.

# Appendix

## Important note

This equipment is not designed for making emergency telephone call when the power fails. Alternative arrangements should be made for access to emergency services.

## Environmental notes

- Do not expose to direct sunlight.
- Do not place your product on carpets or other surfaces which generate fibres, or place in locations where proper ventilation is not provided.
- Do not submerge any part of your product in water and do not use it in damp or humid conditions, such as bathrooms.
- Do not expose your product to fire, explosive or other hazardous conditions.
- Avoid using a telephone (other than cordless) during an electrical storm. There is a remote risk of electric shock from lightning.

## Product disposal instructions

The symbol shown here and on the product means that the product is classed as Electrical or Electronic Equipment and should not be disposed with other household or commercial waste at the end of its working life.

The Waste of Electrical and Electronic Equipment (WEEE) Directive (2012/19/EU) has been put in place to recycle products using best available recovery and recycling techniques to minimize the impact on the environment, treat any hazardous substances and avoid the increasing landfill.



### Product disposal instructions for residential users

When you have no further use for it, please remove any batteries and dispose of them and the product as per your local authority's recycling processes. For more information please contact your local authority or the retailer where the product was purchased.

### Product disposal instructions for business users

Business users should contact their suppliers and check the terms and conditions of the purchase contract and ensure that this product is not mixed with other commercial waste for disposal.

## Technical information

### Specific Absorption Rate (SAR)

This device meets applicable international safety requirements for exposure to radio waves.

The max. limit according to WHO is 2W/kg (per 10g tissue).

This telephone measures 0.03 W/kg (per 10g tissue).

## European Directives

These equipments are compliant with directives 1999/5/EC (R&TTE), 2014/35/EU (LVD), 2014/30/EU (EMC) and 2011/65/EU (ROHS).

## Declaration of Conformance

Hereby, VTech declares that cordless equipment are in compliance with the essential requirements of directive 1999/5/EC (R&TTE) The Declaration of Conformity may be obtained from: [www.vtechhotelphones.com](http://www.vtechhotelphones.com).



## Warning

These are class A products. In a domestic environment these products may cause radio interference in which case the user may be required to take adequate measures.

# Appendix

## Maintenance

### Taking care of the telephone

The telephone contains sophisticated electronic parts, so it must be treated with care.

### Avoid rough treatment

Place the handset down gently. Save the original packing materials to protect the telephone if you ever need to ship it.

### Avoid water

The telephone can be damaged if it gets wet. Do not use the handset outdoors in the rain, or handle it with wet hands. Do not install the telephone base near a sink, bathtub or shower.

### Electrical storms

Electrical storms can sometimes cause power surges harmful to electronic equipment. For your own safety, take caution when using electrical appliances during storms.

### Cleaning the telephone

The telephone has a durable plastic casing that should retain its luster for many years. Clean it only with a soft cloth slightly dampened with water or mild soap. Do not use excess water or cleaning solvents of any kind.

Remember that electrical appliances can cause serious injury if used when you are wet or standing in water. If the telephone base should fall into water, DO NOT RETRIEVE IT UNTIL YOU UNPLUG THE POWER CORD AND/OR TELEPHONE LINE CORD FROM THE WALL. Then remove the telephone by the unplugged cords.

# Appendix

## Technical specifications

### Analog corded lobby - A2100

Power requirement	Line powered 24V or 48V
Size	Telephone base: 8.03 x 5.98 x 3.74 in (204 x 152 x 95 mm) Corded handset: 8.39 x 1.85 x 1.58 in (213 x 47 x 40 mm)



### Analog corded 1-line/2-line - A2210/A2220

Power requirement	Line powered 24V or 48V
Message waiting signal	Steady/periodic high voltage pulse or periodic low voltage pulse
Speed Dial memory	Telephone base: up to 10 memory locations; up to 16 digits
Size	Telephone base: 8.03 x 5.98 x 3.74 in (204 x 152 x 95 mm) Corded handset: 8.39 x 1.85 x 1.58 in (213 x 47 x 40 mm)

### Analog corded trimstyle - A2310

Power requirement	Line powered 24V or 48V
Message waiting signal	Steady/periodic high voltage pulse and periodic low voltage pulse
Size	Telephone base: 8.47 x 2.87 x 2.17 in (215 x 73 x 55 mm) Corded handset: 8.39 x 1.85 x 1.65 in (213 x 47 x 42 mm)



### Analog cordless 1-line/2-line - A2410/A2420

Frequency Control	Crystal controlled PLL synthesizer		
Transmit frequency	Handset: 1881.792-1897.344 MHz Telephone base: 1881.792-1897.344 MHz		
Channels	10		
Nominal effective range	Actual operating range may vary according to environmental conditions at the time of use.		
  Power requirements	Handset: 2.4V Ni-MH battery Telephone base: 6V DC @600mA		
	Country	Manufacturer	Manufacturer model number
	EU	Ten Pao International Ltd.	S004AM0600060
	UK	Ten Pao International Ltd.	S004AM0600060
	Australia	Ten Pao International Ltd.	S004AM0600060
Message waiting signal	Steady/periodic high voltage pulse, periodic low voltage pulse, reverse polarity, FSK, Siemens and/or Panasonic		
Speed Dial memory	Telephone base: up to 10 memory locations; up to 32 digits		
Size	Telephone base: 8.03 x 6.06 x 3.78 in (204 x 154 x 96 mm) Handset: 8.39 x 1.89 x 1.65 in (213 x 48 x 42 mm)		

# Appendix

## Technical specifications

### Analog cordless 1-line/2-line - CTM-A2411/CTM-A2411-BATT/CTM-A2421/CTM-A2421-BATT

Frequency Control	Crystal controlled PLL synthesizer		
Transmit frequency	Handset: 1881.792-1897.344 MHz Telephone base: 1881.792-1897.344 MHz		
Channels	10		
Nominal effective range	Actual operating range may vary according to environmental conditions at the time of use.		
  Power requirements	Handset: 2.4V Ni-MH battery Telephone base: 6V DC @600mA,		
	Country	Manufacturer	Manufacturer model number
	EU	Ten Pao International Ltd.	S004AAM0600060
	UK	Ten Pao International Ltd.	S004AAM0600060
	Australia	Ten Pao International Ltd.	S004AAM0600060
	Telephone base backup battery (for <b>CTM-A2411-BATT/CTM-A2421-BATT</b> ): 2.4V Ni-MH battery		
Message waiting signal	Steady/periodic high voltage pulse, periodic low voltage pulse, reverse polarity, FSK, Siemens and/or Panasonic		
Speed Dial memory	Telephone base: up to 11 memory locations; up to 32 digits Handset: up to 3 memory locations; up to 32 digits		
Size	Telephone base: 8.03 x 6.06 x 3.78 in (204 x 154 x 96 mm) Handset: 8.39 x 1.89 x 1.65 in (213 x 48 x 42 mm)		



### Analog cordless 1-line/2-line deskset - CTM-A241P/CTM-A242P

Frequency Control	Crystal controlled PLL synthesizer		
Transmit frequency	1881.792-1897.344 MHz		
Channels	10		
Nominal effective range	Actual operating range may vary according to environmental conditions at the time of use.		
Power requirement	5.1V DC @1.3 A		
	Country	Manufacturer	Manufacturer model number
	EU	Ten Pao International Ltd.	S009GV0510130
	EU	SunStrong International Industrial LTD.	SSA-10W-05 EU 051130
	UK	Ten Pao International Ltd.	S009GV0510130
	UK	SunStrong International Industrial LTD.	SSA-10W-05 EU 051130
USB port	Provide charging current up to 1A		
Speed Dial memory	Accessory Petite: up to 11 memory locations; up to 32 digits		
Size	Accessory Petite: 8.03 x 6.06 x 3.78 in (204 x 154 x 96 mm) Corded handset: 8.39 x 1.89 x 1.65 in (213 x 48 x 42 mm)		

# Appendix

## Technical specifications

### Analog corded/cordless 1-line - CTM-A2510

Frequency Control	Crystal controlled PLL synthesizer		
Transmit frequency	Handset: 1881.792-1897.344 MHz Telephone base: 1881.792-1897.344 MHz		
Channels	10		
Nominal effective range	Actual operating range may vary according to environmental conditions at the time of use.		
  Power requirements	Handset: 2.4V Ni-MH battery Telephone base: 6V DC @600mA		
	Country	Manufacturer	Manufacturer model number
	EU	Ten Pao International Ltd.	S004AAM0600060
	UK	Ten Pao International Ltd.	S004AAM0600060
	Australia	Ten Pao International Ltd.	S004AAM0600060
	Charging stand: 6V DC @450mA		
	Country	Manufacturer	Manufacturer model number
	EU	VTech(Qing Yuan) Plastic & Electronics Co. LTD	VT04EEU06045
	UK	VTech(Qing Yuan) Plastic & Electronics Co. LTD	VT04UKU06045
	Australia	Ten Pao International Ltd.	S003IS0600045
Message waiting signal	Steady/periodic high voltage pulse, periodic low voltage pulse, reverse polarity, FSK, Siemens and/or Panasonic		
Speed Dial memory	Telephone base: up to 11 memory locations; up to 32 digits Cordless handset: up to 3 memory locations; up to 32 digits		
Size	Telephone base: 8.03 x 6.06 x 3.78 in (204 x 154 x 96 mm) Handset: 8.39 x 1.89 x 1.65 in (213 x 48 x 42 mm) Charging stand: 3.78 x 2.80 x 4.29 in (96 x 71 x 109 mm)		

# Appendix

## Technical specifications

### Analog corded/cordless 1-line - CTM-A2510-USB

Frequency Control	Crystal controlled PLL synthesizer
Transmit frequency	Handset: 1881.792-1897.344 MHz Telephone base: 1881.792-1897.344 MHz
Channels	10
Nominal effective range	Actual operating range may vary according to environmental conditions at the time of use.



#### Power requirements

Handset: 2.4V Ni-MH battery  
Telephone base: 6V DC @600mA

Country	Manufacturer	Manufacturer model number
EU	Ten Pao International Ltd.	S004AAM0600060
UK	Ten Pao International Ltd.	S004AAM0600060
Australia	Ten Pao International Ltd.	S004AAM0600060

Charging stand: 6V DC @1400mA

Country	Manufacturer	Manufacturer model number
EU	SunStrong International Industrial LTD.	SSA-060140EU
UK	SunStrong International Industrial LTD.	SSA-060140UK
Australia	SunStrong International Industrial LTD.	SSA-060140AU

Message waiting signal	Steady/periodic high voltage pulse, periodic low voltage pulse, reverse polarity, FSK, Siemens and/or Panasonic
Speed Dial memory	Telephone base: up to 11 memory locations; up to 32 digits Cordless handset: up to 3 memory locations; up to 32 digits
Size	Telephone base: 8.03 x 6.06 x 3.78 in (204 x 154 x 96 mm) Handset: 8.39 x 1.89 x 1.65 in (213 x 48 x 42 mm) Charging stand: 3.78 x 2.80 x 4.29 in (96 x 71 x 109 mm)
USB charging port	Provide charging current up to 1A

### Analog cordless charging base - C4000

Power requirement	6V DC @600mA	
	Country	Manufacturer
	EU	Ten Pao International Ltd.
	UK	Ten Pao International Ltd.
	Australia	Ten Pao International Ltd.
		Manufacturer model number
		S004AM0600060
		S004AM0600060
		S004AM0600060

Size	8.11 x 3.70 x 2.87 in (206 x 94 x 73 mm)
------	--

### Analog cordless charging base - C4001

Power requirement	6V DC @450mA	
	Country	Manufacturer
	EU	VTech(Qing Yuan) Plastic & Electronics Co. LTD
	UK	VTech(Qing Yuan) Plastic & Electronics Co. LTD
	Australia	Ten Pao International Ltd.
		Manufacturer model number
		VT04EEU06045
		VT04UKU06045
		S003IS0600045

Size	8.11 x 3.70 x 2.87 in (206 x 94 x 73 mm)
------	--

# Appendix

## Technical specifications

### Analog cordless charging stand - C4010

Power requirement	6V DC @600mA		
	Country	Manufacturer	Manufacturer model number
	EU	Ten Pao International Ltd.	S004AM0600060
	UK	Ten Pao International Ltd.	S004AM0600060
Australia	Ten Pao International Ltd.	S004AM0600060	
Size	3.78 x 2.80 x 4.29 in (96 x 71 x 109 mm)		



### Analog cordless charging stand - C4011

Power requirement	6V DC @450mA		
	Country	Manufacturer	Manufacturer model number
	EU	VTech(Qing Yuan) Plastic & Electronics Co. LTD	VT04EEU06045
	UK	VTech(Qing Yuan) Plastic & Electronics Co. LTD	VT04UKU06045
Australia	Ten Pao International Ltd.	S003IS0600045	
Size	3.78 x 2.80 x 4.29 in (96 x 71 x 109 mm)		

### Analog cordless charging stand - C4011-USB

Power requirement	6V DC @1400mA		
	Country	Manufacturer	Manufacturer model number
	EU	SunStrong International Industrial LTD.	SSA-060140EU
	UK	SunStrong International Industrial LTD.	SSA-060140UK
Australia	SunStrong International Industrial LTD.	SSA-060140AU	
Size	3.78 x 2.80 x 4.29 in (96 x 71 x 109 mm)		
USB charging port	Provide charging current up to 1A		

### Analog cordless 1-line/2-line accessory handset - C4100/C4200

Frequency Control	Crystal controlled PLL synthesizer
Transmit frequency	1881.792-1897.344 MHz
Channels	10
Nominal effective range	Actual operating range may vary according to environmental conditions at the time of use.
 	
Power requirement	2.4V Ni-MH battery
Message waiting signal	Steady/periodic high voltage pulse, periodic low voltage pulse, reverse polarity, FSK, Siemens and/or Panasonic
Size	8.39 x 1.89 x 1.65 in (213 x 48 x 42 mm)



# Appendix

## Technical specifications

### Analog cordless 1-line/2-line accessory handset - CTM-C4101/CTM-C4201

Frequency Control	Crystal controlled PLL synthesizer
Transmit frequency	1881.792-1897.344 MHz
Channels	10
Nominal effective range	Actual operating range may vary according to environmental conditions at the time of use.
 Power requirement	2.4V Ni-MH battery
Message waiting signal	Steady/periodic high voltage pulse, periodic low voltage pulse, reverse polarity, FSK, Siemens and/or Panasonic
Speed Dial memory	Handset: up to 3 memory locations; up to 32 digits
Size	8.39 x 1.89 x 1.65 in (213 x 48 x 42 mm)

### Analog cordless 1-line/2-line accessory handset and charger bundle - CTM-A241HS/CTM-A242HS

Frequency Control	Crystal controlled PLL synthesizer												
Transmit frequency	1881.792-1897.344 MHz												
Channels	10												
Nominal effective range	Actual operating range may vary according to environmental conditions at the time of use.												
 Power requirement	Cordless handset: 2.4V Ni-MH battery Charging stand: 6V DC @450mA												
	<table border="1"> <thead> <tr> <th>Country</th> <th>Manufacturer</th> <th>Manufacturer model number</th> </tr> </thead> <tbody> <tr> <td>EU</td> <td>VTech(Qing Yuan) Plastic &amp; Electronics Co. LTD</td> <td>VT04EEU06045</td> </tr> <tr> <td>UK</td> <td>VTech(Qing Yuan) Plastic &amp; Electronics Co. LTD</td> <td>VT04UKU06045</td> </tr> <tr> <td>Australia</td> <td>Ten Pao International Ltd.</td> <td>S003IS0600045</td> </tr> </tbody> </table>	Country	Manufacturer	Manufacturer model number	EU	VTech(Qing Yuan) Plastic & Electronics Co. LTD	VT04EEU06045	UK	VTech(Qing Yuan) Plastic & Electronics Co. LTD	VT04UKU06045	Australia	Ten Pao International Ltd.	S003IS0600045
Country	Manufacturer	Manufacturer model number											
EU	VTech(Qing Yuan) Plastic & Electronics Co. LTD	VT04EEU06045											
UK	VTech(Qing Yuan) Plastic & Electronics Co. LTD	VT04UKU06045											
Australia	Ten Pao International Ltd.	S003IS0600045											
Message waiting signal	Steady/periodic high voltage pulse, periodic low voltage pulse, reverse polarity, FSK, Siemens and/or Panasonic												
Size	Cordless handset: 8.39 x 1.89 x 1.65 in (213 x 48 x 42 mm) Charging stand: 3.78 x 2.80 x 4.29 in (96 x 71 x 109 mm)												

### Analog cordless 1-line/2-line accessory handset with speed dials and charger bundle - CTM-A241SD/CTM-A242SD

Frequency Control	Crystal controlled PLL synthesizer												
Transmit frequency	1881.792-1897.344 MHz												
Channels	10												
Nominal effective range	Actual operating range may vary according to environmental conditions at the time of use.												
 Power requirement	Cordless handset: 2.4V Ni-MH battery Charging stand: 6V DC @450mA												
	<table border="1"> <thead> <tr> <th>Country</th> <th>Manufacturer</th> <th>Manufacturer model number</th> </tr> </thead> <tbody> <tr> <td>EU</td> <td>VTech(Qing Yuan) Plastic &amp; Electronics Co. LTD</td> <td>VT04EEU06045</td> </tr> <tr> <td>UK</td> <td>VTech(Qing Yuan) Plastic &amp; Electronics Co. LTD</td> <td>VT04UKU06045</td> </tr> <tr> <td>Australia</td> <td>Ten Pao International Ltd.</td> <td>S003IS0600045</td> </tr> </tbody> </table>	Country	Manufacturer	Manufacturer model number	EU	VTech(Qing Yuan) Plastic & Electronics Co. LTD	VT04EEU06045	UK	VTech(Qing Yuan) Plastic & Electronics Co. LTD	VT04UKU06045	Australia	Ten Pao International Ltd.	S003IS0600045
Country	Manufacturer	Manufacturer model number											
EU	VTech(Qing Yuan) Plastic & Electronics Co. LTD	VT04EEU06045											
UK	VTech(Qing Yuan) Plastic & Electronics Co. LTD	VT04UKU06045											
Australia	Ten Pao International Ltd.	S003IS0600045											
Message waiting signal	Steady/periodic high voltage pulse, periodic low voltage pulse, reverse polarity, FSK, Siemens and/or Panasonic												
Speed Dial memory	Handset: up to 3 memory locations; up to 32 digits												
Size	Cordless handset: 8.39 x 1.89 x 1.65 in (213 x 48 x 42 mm) Charging stand: 3.78 x 2.80 x 4.29 in (96 x 71 x 109 mm)												

# Index

## A

A2100 5, 28–29, 57–58, 63  
A2210 6, 28–29, 57–58, 64–65  
A2220 7, 28–29, 57–58, 66–67  
A2310 8, 30–31, 57–58, 68  
A2410 9, 32–33, 37–38, 59–62, 69–71  
A2420 12, 32–33, 37–38, 59–62, 73–75  
Answer an intercom call 71, 75

## B

Battery charging 34, 38, 40, 47, 54, 56  
Battery installation 34, 37, 39, 46, 53, 55

## C

C4000 17, 49  
C4001 17, 50  
C4010 18, 51  
C4011 18, 52  
C4011-USB 19, 52  
C4100 20, 53–54  
C4200 24, 53–54  
Call waiting 64, 66, 68, 70, 72, 74, 76, 79  
Charging 34, 38, 40, 47, 54, 56  
Checklist 1–4  
Conference call 67, 75, 77  
CTM-A2411 10, 32–33, 39–40, 59–62, 69–71  
CTM-A2411-BATT 10, 34–36, 39–40, 59–62, 69–71  
CTM-A241HS 22, 52, 53–54  
CTM-A241P 11, 41–43, 59–62, 72  
CTM-A241SD 23, 52, 55–56, 59–62  
CTM-A2421 13, 32–33, 39–40, 59–62, 73–75  
CTM-A2421-BATT 13, 34–36, 39–40, 59–62, 73–75  
CTM-A242HS 26, 52, 53–54  
CTM-A242P 14, 41–43, 59–62, 76–77  
CTM-A242SD 27, 52, 55–56, 59–62  
CTM-A2510 15, 44–48, 59–62, 78–80  
CTM-A2510-USB 16, 44–48, 59–62, 78–80  
CTM-C4101 21, 55–56, 59–62  
CTM-C4201 25, 59–62

## D

Data port 63, 65, 67, 68, 71, 75, 80  
Default settings 57, 59  
Deregister a handset 38, 40, 47, 54, 56  
Deregister an accessory Petite 43

## E

End a call 63, 64, 66, 68, 69, 72, 73, 76, 78  
End a conference call 67, 75, 77  
End an intercom call 71, 75  
Environmental notes 86

## F

Find handset 71, 75, 80  
Flash 57, 59, 64, 66, 68, 70, 72, 74, 76, 79

## H

Handset battery 81  
Handset battery installation 37, 39, 46, 53, 55  
Handset battery replacement 37, 39, 46, 53, 55  
Handset charging 38, 40, 47, 54, 56  
Handset deregistration 38, 40, 47, 54, 56  
Handset registration 38, 40, 47, 54, 56  
Handset speakerphone 70, 73, 79  
Hold 59, 60, 65, 67, 70, 72, 74, 76, 79

## I

Initiate a conference call 67, 75, 77  
Initiate an intercom call 71, 74  
Installation 28–56  
Intercom 71, 74–75

## J

Join a call 64, 66, 68, 69, 72, 73, 76, 78

## L

Layout 5–25  
Limited warranty 85  
Listening volume 63, 64, 66, 68, 70, 72, 74, 76, 79

## M

Maintenance 87  
Mute 64, 67, 68, 70, 72, 74, 76, 79

## O

Operation 63–80

## P

Paging handset 71, 75, 80  
Parts checklist 1–4  
Place a call 63, 64, 66, 68, 69, 72, 73, 76, 78  
Product disposal instructions 86

## R

R&TTE 86  
Receive a call 63, 64, 66, 68, 69, 72, 73, 76, 78  
Redial 70, 74, 79  
Register a handset 38, 40, 47, 54, 56  
Register a handset to another telephone base 38, 40, 47, 54, 56  
Register an accessory Petite 43  
Register an accessory Petite to another telephone base 43  
Replace a handset battery 37, 39, 46, 53, 55  
Replace a telephone base backup battery 34  
RF transmission power 59  
Ringer tone 57, 59  
Ringer volume 57, 59, 63, 64, 66, 68, 70, 72, 74, 76, 79

## S

Settings 57–62  
Share a call 64, 66, 68, 69, 72, 73, 76, 78  
Speakerphone 57, 59, 64, 66, 69, 70, 72, 73, 74, 76, 78, 79  
Speed Dial keys 58, 61–62

## T

Technical information 86  
Technical specifications 88–92  
Troubleshooting 82–84

## U

USB port 72, 77, 80

## V

Voicemail voltage detection 58, 60–61  
Volume 57, 59, 63, 64, 66, 68, 70, 72, 74, 76, 79

## W

Wall mount 29, 31, 33, 36, 42, 45, 49, 50  
Warranty 85



**vtech**®

VTECH TELECOMMUNICATIONS LTD.  
A member of THE VTECH GROUP OF COMPANIES.  
VTech is the registered trademark of VTech Holdings Limited.  
Petite™ Phone is a trademark of VTech Communications, Inc.  
Copyright © 2021 for VTECH TELECOMMUNICATIONS LTD  
Analog\_Contemporary\_EU\_UG\_V9\_20210223.  
All rights reserved. 02/21. Printed in China.

91-004764-030-100